

INTERNATIONAL
STANDARD

ISO/IEC
24775-6

Second edition
2021-03

**Information technology — Storage
management —**

Part 6:
Fabric



Reference number
ISO/IEC 24775-6:2021(E)

© ISO/IEC 2021



COPYRIGHT PROTECTED DOCUMENT

© ISO/IEC 2021

All rights reserved. Unless otherwise specified, or required in the context of its implementation, no part of this publication may be reproduced or utilized otherwise in any form or by any means, electronic or mechanical, including photocopying, or posting on the internet or an intranet, without prior written permission. Permission can be requested from either ISO at the address below or ISO's member body in the country of the requester.

ISO copyright office
CP 401 • Ch. de Blandonnet 8
CH-1214 Vernier; Geneva
Phone: +41 22 749 01 11
Email: copyright@iso.org
Website: www.iso.org

Published in Switzerland

Foreword

ISO (the International Organization for Standardization) and IEC (the International Electrotechnical Commission) form the specialized system for worldwide standardization. National bodies that are members of ISO or IEC participate in the development of International Standards through technical committees established by the respective organization to deal with particular fields of technical activity. ISO and IEC technical committees collaborate in fields of mutual interest. Other international organizations, governmental and non-governmental, in liaison with ISO and IEC, also take part in the work.

The procedures used to develop this document and those intended for its further maintenance are described in the ISO/IEC Directives, Part 1. In particular, the different approval criteria needed for the different types of document should be noted (see www.iso.org/directives).

Attention is drawn to the possibility that some of the elements of this document may be the subject of patent rights. ISO and IEC shall not be held responsible for identifying any or all such patent rights. Details of any patent rights identified during the development of the document will be in the Introduction and/or on the ISO list of patent declarations received (see www.iso.org/patents) or the IEC list of patent declarations received (see <http://patents.iec.ch>).

Any trade name used in this document is information given for the convenience of users and does not constitute an endorsement.

For an explanation of the voluntary nature of standards, the meaning of ISO specific terms and expressions related to conformity assessment, as well as information about ISO's adherence to the World Trade Organization (WTO) principles in the Technical Barriers to Trade (TBT), see www.iso.org/iso/foreword.html.

This document was prepared by SNIA (as Storage Management Technical Specification, Part 6 Fabric, Version 1.8.0, Revision 5) and drafted in accordance with its editorial rules. It was adopted, under the JTC 1 PAS procedure, by Joint Technical Committee ISO/IEC JTC 1, *Information technology*.

This second edition cancels and replaces the first edition (ISO/IEC 24775-6:2014), which has been technically revised.

The main changes compared to the previous edition are as follows:

- USAGE text was revised to address code (now included in the front matter for all SNIA specifications)
- All recipes and their references were deleted.
- Instances of subprofile were changed to profile. In the annex, instances of subprofile were changed to component profile (TSG meeting voice vote).
- Profile versions and related text were updated. (TSG meeting voice vote).
- Indications have been replaced by DMTF Indications, and all affected clauses updated. (TSG meeting voice vote).
- Instances of Experimental within profiles already labeled as Experimental were removed to avoid confusion and redundancy. (Editorial change)
- CIM/XML was changed to CIM-XML (Response to ballot comments).

ISO/IEC 24775-6:2021(E)

- Annex: SMI-S Information Model.
- The CIM schema version was changed to 2.51 for V1.8.0 Rev3.
- Blades Profile
 - Added descriptions for References in CIM_ProductPhysicalComponent.
 - Changed the version to 1.7.0.
- Enhanced Zoning and Enhanced Zoning Control Profile (SMI TWG Reviews)
 - Fixed the version numbers on the Related Profiles to match what the profiles claim.
- Fabric Profile
 - Corrected the Related Profile for FabricVirtualFabrics to be Virtual Fabrics.
 - Fixed the version numbers on the Related Profiles to match what the profiles claim.
 - Deleted the MemberOfCollections in the CIM Elements for the filter collections that were deleted.
 - Defined the condition for Peer Zoning in CIM_ZoneSettingData ZoneMembershipSettingData to Zone).
- Fabric Views Profile
 - In FCSwitchView changed OperationalStatus to SwitchOperationalStatus and FCPortEnabledState to PortEnabledState.
 - In ConcreteComponentView changed Antecedent and Dependent to GroupComponent and PartComponent.
 - Changed the version of the profile to 1.7.0.
 - Changed the Central Class from FCTopologyView to CIM_ViewCapabilities (TSG-SMIS-SCR00333).
- FCoE Fabric (TSG-SMIS-SCR00331)
 - Reworked the profile to be a component profile of the Fabric Profile.
 - Removed the classes associated with experimental indications.
 - Added a definition of CIM_EthernetPort (which was missing).
 - Fixed a number of mifgen warnings.
- FDMI Profile
 - Changed the version of the Profile to be 1.8.0, since we expanded the Speed enumerations
- Inter Fabric Routing Profile
 - Added a SystemDevice between the IFR Switch and the IFR FCPort.
 - Changed the Profile version to 1.7.0.
 - Changed the Central Class from ComputerSystem to CIM_ComputerSystem (IFR Switch) (TSG-SMIS-SCR00333).
- N Port Virtualizer Profile
 - Fixed the version numbers on the Related Profiles to match what the profiles claim.
 - Changed the Central Class from FCPort to CIM_FCPort (Fabric NPIV) (TSG-SMIS-SCR00333).

- Switch Partitioning Profile
 - Changed the name of the profile to "Switch Partitioning" to make the spec readable.
 - Changed "must" to "shall" in a number of CIM Element tables.
 - Changed the Central Class from ComputerSystem to CIM_ComputerSystem (Partitioning) (TSG-SMISSCR00333).
- Switch Profile
 - Fixed the version numbers on the Related Profiles to match what the profiles claim.
 - Changed the version of the profile to 1.8.0, due to changes to the enumeration of the Speed property.
 - Removed the Switch Configuration Data profile from Related Profiles table, since it has been removed from the spec.
 - Changed the name of the FabricSwitchPartitioning Profile to Switch Partitioning in the Related Profiles table.
 - Changed the Requirement for CIM_ElementSettingData (FCSwitchSettings to ComputerSystem) to Mandatory, since FCSwitchSettings and the Switch are Mandatory.
- Virtual Fabrics Profile
 - Changed the name of the profile to "Virtual Fabrics" to make the spec readable.
- Zone Control Profile
 - Changed the version of the Profile to be 1.8.0, since we added two methods.
- Annex B (Informative) Structure of Fabric Profiles (TSG-SMIS-SCR00331)
 - Updated Figure B.1 to show how FCoE Fabrics fits into the structure of Fabric profiles.
- References
 - Added DMTF DSP1054 v1.2.2, Indications Profile (and changed to V1.2.2 throughout book).
 - Removed SPC-2.
 - Moved SPC-3 reference from 2.2 to 2.1.

A list of all parts in the ISO/IEC 24775 series can be found on the ISO website.

Any feedback or questions on this document should be directed to the user's national standards body. A complete listing of these bodies can be found at www.iso.org/members.html.

INTENDED AUDIENCE

This document is intended for use by individuals and companies engaged in developing, deploying, and promoting interoperable multi-vendor SANs through the Storage Networking Industry Association (SNIA) organization.

CHANGES TO THE SPECIFICATION

Each publication of this specification is uniquely identified by a three-level identifier, comprised of a version number, a release number and an update number. The current identifier for this specification is version 1.8.0. Future publications of this specification are subject to specific constraints on the scope of change that is permissible from one publication to the next and the degree of interoperability and backward compatibility that should be assumed between products designed to different publications of this standard. The SNIA has defined three levels of change to a specification:

- **Major Revision:** A major revision of the specification represents a substantial change to the underlying scope or architecture of the SMI-S API. A major revision results in an increase in the version number of the version identifier (e.g., from version 1.x.x to version 2.x.x). There is no assurance of interoperability or backward compatibility between releases with different version numbers.
- **Minor Revision:** A minor revision of the specification represents a technical change to existing content or an adjustment to the scope of the SMI-S API. A minor revision results in an increase in the release number of the specification's identifier (e.g., from x.1.x to x.2.x). Minor revisions with the same version number preserve interoperability and backward compatibility.
- **Update:** An update to the specification is limited to minor corrections or clarifications of existing specification content. An update will result in an increase in the third component of the release identifier (e.g., from x.x.1 to x.x.2). Updates with the same version and minor release levels preserve interoperability and backward compatibility.

TYPOGRAPHICAL CONVENTIONS

Maturity Level

In addition to informative and normative content, this specification includes guidance about the maturity of emerging material that has completed a rigorous design review but has limited implementation in commercial products. This material is clearly delineated as described in the following sections. The typographical convention is intended to provide a sense of the maturity of the affected material, without altering its normative content. By recognizing the relative maturity of different sections of the standard, an implementer should be able to make more informed decisions about the adoption and deployment of different portions of the standard in a commercial product.

This specification has been structured to convey both the formal requirements and assumptions of the SMI-S API and its emerging implementation and deployment lifecycle. Over time, the intent is that all content in the specification will represent a mature and stable design, be verified by extensive implementation experience, assure consistent support for backward compatibility, and rely solely on content material that has reached a similar level of maturity. Unless explicitly labeled with one of the subordinate maturity levels defined for this specification, content is assumed to satisfy these requirements and is referred to as "Finalized". Since much of the evolving specification

content in any given release will not have matured to that level, this specification defines three subordinate levels of implementation maturity that identify important aspects of the content's increasing maturity and stability. Each subordinate maturity level is defined by its level of implementation experience, its stability and its reliance on other emerging standards. Each subordinate maturity level is identified by a unique typographical tagging convention that clearly distinguishes content at one maturity model from content at another level.

Experimental Maturity Level

No material is included in this document unless its initial architecture has been completed and reviewed. Some content included in this document has complete and reviewed design, but lacks implementation experience and the maturity gained through implementation experience. This content is included in order to gain wider review and to gain implementation experience. This material is referred to as “Experimental”. It is presented here as an aid to implementers who are interested in likely future developments within the SMI specification. The contents of an Experimental profile may change as implementation experience is gained. There is a high likelihood that the changed content will be included in an upcoming revision of the specification. Experimental material can advance to a higher maturity level as soon as implementations are available. Figure 1 is a sample of the typographical convention for Experimental content.

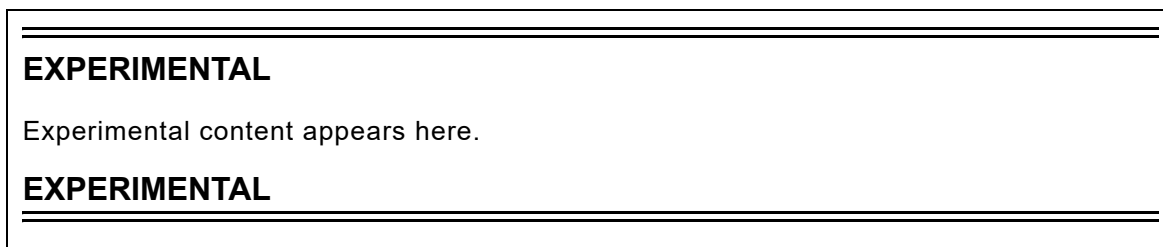

Figure 1 - Experimental Maturity Level Tag

Implemented Maturity Level

Profiles for which initial implementations have been completed are classified as “Implemented”. This indicates that at least two different vendors have implemented the profile, including at least one provider implementation. At this maturity level, the underlying architecture and modeling are stable, and changes in future revisions will be limited to the correction of deficiencies identified through additional implementation experience. Should the material become obsolete in the future, it must be deprecated in a minor revision of the specification prior to its removal from subsequent releases. Figure 2 is a sample of the typographical convention for Implemented content.

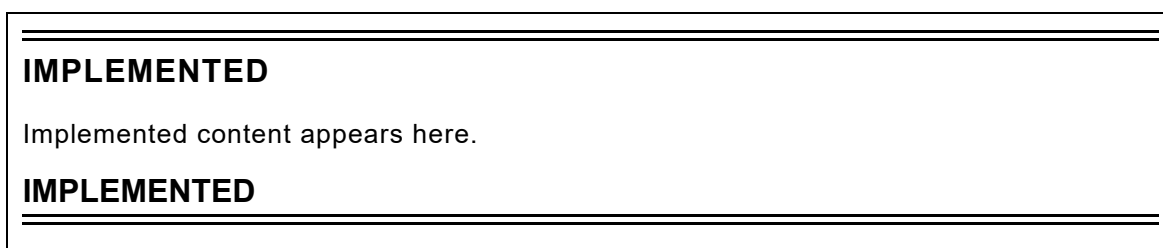

Figure 2 - Implemented Maturity Level Tag

Stable Maturity Level

Once content at the Implemented maturity level has garnered additional implementation experience, it can be tagged at the Stable maturity level. Material at this maturity level has been implemented by three different vendors, including both a provider and a client. Should material that has reached this maturity level become obsolete, it may only be deprecated as part of a minor revision to the specification. Material at this maturity level that has been deprecated may only be removed from the specification as part of a major revision. A profile that has reached this maturity level is guaranteed to preserve backward compatibility from one minor specification revision to the next. As a result, Profiles at or above the Stable

maturity level shall not rely on any content that is Experimental. Figure 3 is a sample of the typographical convention for Implemented content.



Figure 3 - Stable Maturity Level Tag

Finalized Maturity Level

Content that has reached the highest maturity level is referred to as “Finalized.” In addition to satisfying the requirements for the Stable maturity level, content at the Finalized maturity level must solely depend upon or refine material that has also reached the Finalized level. If specification content depends upon material that is not under the control of the SNIA, and therefore not subject to its maturity level definitions, then the external content is evaluated by the SNIA to assure that it has achieved a comparable level of completion, stability, and implementation experience. Should material that has reached this maturity level become obsolete, it may only be deprecated as part of a major revision to the specification. A profile that has reached this maturity level is guaranteed to preserve backward compatibility from one minor specification revision to the next. Over time, it is hoped that all specification content will attain this maturity level. Accordingly, there is no special typographical convention, as there is with the other, subordinate maturity levels. Unless content in the specification is marked with one of the typographical conventions defined for the subordinate maturity levels, it should be assumed to have reached the Finalized maturity level.

Deprecated Material

Non-Experimental material can be deprecated in a subsequent revision of the specification. Sections identified as “Deprecated” contain material that is obsolete and not recommended for use in new development efforts. Existing and new implementations may still use this material, but shall move to the newer approach as soon as possible. The maturity level of the material being deprecated determines how long it will continue to appear in the specification. Implemented content shall be retained at least until the next revision of the specialization, while Stable and Finalized material shall be retained until the next major revision of the specification. Providers shall implement the deprecated elements as long as it appears in the specification in order to achieve backward compatibility. Clients may rely on deprecated elements, but are encouraged to use non-deprecated alternatives when possible.

Deprecated sections are documented with a reference to the last published version to include the deprecated section as normative material and to the section in the current specification with the replacement. Figure 4 contains a sample of the typographical convention for deprecated content.



Figure 4 - Deprecated Tag

Contents

List of Figures	17
List of Tables	19
Foreword	25
1 Scope	27
2 Normative References	29
2.1 Approved references	29
2.2 References under development	29
2.3 Other references	29
3 Terms, Definitions, Symbols, Abbreviations, and Conventions	31
4 Fabric Profile	33
4.1 Synopsis	33
4.2 Description	34
4.3 Health and Fault Management	40
4.4 Cascading Considerations	40
4.5 Methods of this Profile	40
4.6 Use Cases	44
4.7 CIM Elements	46
5 Enhanced Zoning and Enhanced Zone Control Profile	73
5.1 Synopsis	73
5.2 Description	73
5.3 Health and Fault Management	73
5.4 Cascading Considerations	73
5.5 Methods of this Profile	73
5.6 Use Cases	74
5.7 CIM Elements	74
6 Zone Control Profile	77
6.1 Synopsis	77
6.2 Description	77
6.3 Durable Names and Correlatable IDs of the Profile	77
6.4 Instrumentation Requirements	77
6.5 Health and Fault Management	77
6.6 Cascading Considerations	77
6.7 Methods of this Profile	78
6.8 Use Cases	83
6.9 CIM Elements	83
7 FDMI Profile	87
7.1 Synopsis	87
7.2 Description	87
7.3 Health and Fault Management	88
7.4 Cascading Considerations	88
7.5 Methods of this Profile	88
7.6 Use Cases	88
7.7 CIM Elements	89
8 Fabric Views Profile	99
8.1 Description	99
8.2 Health and Fault Management Consideration	102
8.3 Cascading Considerations	103

8.4	Methods of the Profile	103
8.5	Use Cases.....	103
8.6	CIM Elements.....	103
9	Virtual Fabrics.....	109
9.1	Synopsis.....	109
9.2	Description	109
9.3	Health and Fault Management Consideration.....	112
9.4	Cascading Considerations	112
9.5	Methods of the Profile	112
9.6	Use Cases.....	112
9.7	CIM Elements.....	113
10	Switch Profile.....	115
10.1	Synopsis.....	115
10.2	Description	115
10.3	Health and Fault Management.....	120
10.4	Cascading Considerations	120
10.5	Methods of this Profile.....	120
10.6	Use Cases.....	120
10.7	CIM Elements.....	121
11	Blades Profile	139
11.1	Synopsis.....	139
11.2	Description	139
11.3	Instance Diagram	139
11.4	Health and Fault Management.....	139
11.5	Cascading Considerations	140
11.6	Methods of this Profile.....	140
11.7	Use Cases.....	140
11.8	CIM Elements.....	140
12	Switch Partitioning	145
12.1	Synopsis.....	145
12.2	Description	145
12.3	Health and Fault Management Consideration.....	147
12.4	Cascading Considerations	147
12.5	Methods of the Profile	147
12.6	Use Cases.....	147
12.7	CIM Elements.....	147
13	N Port Virtualizer Profile	155
13.1	Synopsis.....	155
13.2	Description	155
13.3	Implementation.....	156
13.4	Health and Fault Management Consideration.....	157
13.5	Cascading Considerations	157
13.6	Methods of the Profile	157
13.7	Use Cases.....	157
13.8	CIM Elements.....	157
14	Inter Fabric Routing Profile.....	165
14.1	Synopsis.....	165
14.2	Description	165
14.3	Health and Fault Management Consideration.....	168
14.4	Cascading Considerations	168

14.5	Methods of the Profile	168
14.6	Use Cases.....	168
14.7	CIM Elements.....	169
15	FCoE Fabric	177
15.1	Synopsis.....	177
15.2	Description	177
15.3	Health and Fault Management Consideration.....	178
15.4	Methods of the Profile	178
15.5	Use Cases.....	178
15.6	CIM Elements.....	179
Annex A (informative) SMI-S Information Model.....		189
Annex B (Informative) Structure of Fabric Profiles.....		191

LIST OF FIGURES

Figure 1 - Experimental Maturity Level Tag	10
Figure 2 - Implemented Maturity Level Tag	10
Figure 3 - Stable Maturity Level Tag	11
Figure 4 - Deprecated Tag	11
Figure 5 - Fabric Instance	34
Figure 6 - NPIV Instance	36
Figure 7 - Zoning Instance (AdminDomain)	37
Figure 8 - Zoning Instance (ComputerSystem)	38
Figure 9 - Zoning Instance (Peer Zoning)	39
Figure 10 - FDMI Instance	88
Figure 11 - Class Diagram for Fabric View Classes	100
Figure 12 - Fabric View Class Capabilities	101
Figure 13 - FCTopology View Class	102
Figure 14 - FCSwitch View Class	102
Figure 15 - RegisteredProfile, AdminDomain, and ComputerSystem Relationships	110
Figure 16 - Two Virtual Fabric and Two Partitioning Systems	111
Figure 17 - Two Virtual Fabrics and One Partitioning System	112
Figure 18 - Switch Instance Diagram	117
Figure 19 - Trunking Instance Diagram	118
Figure 20 - Switch Blade Instance	139
Figure 21 - Switch ComputerSystem and Partitioning System	145
Figure 22 - Switch and Partitioning System and Partitioning Ports	146
Figure 23 - Underlying System Port Settings and Capabilities	146
Figure 24 - N Port Virtualizer	156
Figure 25 - IFR Switch Topology	166
Figure 26 - Inter Fabric Routing Ports	168
Figure 27 - FCoE Fabric Instance Diagram	178
Figure B.1 The structure of the Fabric Part Profiles	191
Figure B.2 AdminDomain Properties	194
Figure B.3 Associations on AdminDomains	196
Figure B.4 Properties of various Switches	198
Figure B.5 Associations on Switches	200
Figure B.6 General ComputerSystem Properties	202
Figure B.7 General ComputerSystem Associations	204
Figure B.8 Switch FCPort Properties	206
Figure B.9 Switch FCPort Associations	208
Figure B.10 Non-Switch Port Properties	210
Figure B.11 Non-Switch Port Associations	212

LIST OF TABLES

Table 1 - Supported Profiles for Fabric.....	33
Table 2 - Port OperationalStatus	45
Table 3 - OperationalStatus for ComputerSystem.....	45
Table 4 - CIM Elements for Fabric.....	46
Table 5 - SMI Referenced Properties/Methods for CIM_ActiveConnection.....	48
Table 6 - SMI Referenced Properties/Methods for CIM_AdminDomain (Fabric).....	49
Table 7 - SMI Referenced Properties/Methods for CIM_AdminDomain (SAN)	49
Table 8 - SMI Referenced Properties/Methods for CIM_Component (Platform to Fabric)	50
Table 9 - SMI Referenced Properties/Methods for CIM_Component (Switch to Fabric)	50
Table 10 - SMI Referenced Properties/Methods for CIM_ComputerSystem (Host Platform).....	51
Table 11 - SMI Referenced Properties/Methods for CIM_ComputerSystem (Partitioned Switch).....	51
Table 12 - SMI Referenced Properties/Methods for CIM_ComputerSystem (Storage Platform)	52
Table 13 - SMI Referenced Properties/Methods for CIM_ComputerSystem (Switch).....	53
Table 14 - SMI Referenced Properties/Methods for CIM_ConnectivityCollection	53
Table 15 - SMI Referenced Properties/Methods for CIM_ContainedDomain.....	54
Table 16 - SMI Referenced Properties/Methods for CIM_DeviceSAPImplementation (Non-Switch to FCPort).....	54
Table 17 - SMI Referenced Properties/Methods for CIM_DeviceSAPImplementation (Switch to FCPort)	55
Table 18 - SMI Referenced Properties/Methods for CIM_ElementCapabilities (ZoneCapabilities to Fabric.).....	55
Table 19 - SMI Referenced Properties/Methods for CIM_ElementCapabilities (ZoneCapabilities to Switch.)	55
Table 20 - SMI Referenced Properties/Methods for CIM_ElementSettingData (ZoneMembershipSettingData to Zone)56	
Table 21 - SMI Referenced Properties/Methods for CIM_FCActiveConnection	56
Table 22 - SMI Referenced Properties/Methods for CIM_FCPort (Host FCPort).....	57
Table 23 - SMI Referenced Properties/Methods for CIM_FCPort (Host NPIV FCPort).....	58
Table 24 - SMI Referenced Properties/Methods for CIM_FCPort (Partitioned Switch FCPort).....	59
Table 25 - SMI Referenced Properties/Methods for CIM_FCPort (Storage FCPort).....	60
Table 26 - SMI Referenced Properties/Methods for CIM_FCPort (Switch FCPort).....	61
Table 27 - SMI Referenced Properties/Methods for CIM_HostedAccessPoint (AdminDomain to ProtocolEndpoint)62	
Table 28 - SMI Referenced Properties/Methods for CIM_HostedAccessPoint (ComputerSystem to ProtocolEndpoint)63	
Table 29 - SMI Referenced Properties/Methods for CIM_HostedCollection (Fabric to ConnectivityCollection).....	63
Table 30 - SMI Referenced Properties/Methods for CIM_HostedCollection (System to LogicalPortGroup)	63
Table 31 - SMI Referenced Properties/Methods for CIM_HostedCollection (Zones or ZoneSets to Fabric)	64
Table 32 - SMI Referenced Properties/Methods for CIM_HostedCollection (Zones or ZoneSets to Switch).....	64
Table 33 - SMI Referenced Properties/Methods for CIM_HostedDependency	65
Table 34 - SMI Referenced Properties/Methods for CIM_LogicalPortGroup.....	65
Table 35 - SMI Referenced Properties/Methods for CIM_MemberOfCollection (ConnectivityCollection to ProtocolEndpoint)65	
Table 36 - SMI Referenced Properties/Methods for CIM_MemberOfCollection (LogicalPortGroup to FCPort)	66
Table 37 - SMI Referenced Properties/Methods for CIM_MemberOfCollection (ZoneSet to Zone).....	66
Table 38 - SMI Referenced Properties/Methods for CIM_ProtocolEndpoint	66
Table 39 - SMI Referenced Properties/Methods for CIM_SystemDevice (Non-Switch FCPort to Fabric)	67
Table 40 - SMI Referenced Properties/Methods for CIM_SystemDevice (Non-Switch FCPort to Platform)	67
Table 41 - SMI Referenced Properties/Methods for CIM_SystemDevice (Switch FCPort to Switch).....	68
Table 42 - SMI Referenced Properties/Methods for CIM_Zone (Active)	68

Table 43 - SMI Referenced Properties/Methods for CIM_Zone (Inactive).....	68
Table 44 - SMI Referenced Properties/Methods for CIM_ZoneCapabilities.....	69
Table 45 - SMI Referenced Properties/Methods for CIM_ZoneMembershipSettingData.....	70
Table 46 - SMI Referenced Properties/Methods for CIM_ZoneSet (Active).....	70
Table 47 - SMI Referenced Properties/Methods for CIM_ZoneSet (Inactive).....	71
Table 48 - SMI Referenced Properties/Methods for CIM_ZoneSettingData (ZoneMembershipSettingData to Zone)71	
Table 49 - Supported Profiles for Enhanced Zoning and Enhanced Zoning Control.....	73
Table 50 - CIM Elements for Enhanced Zoning and Enhanced Zoning Control.....	74
Table 51 - SMI Referenced Properties/Methods for CIM_ElementSettingData (ZoneMembershipSettingData to NamedAddressCollection)74	
Table 52 - SMI Referenced Properties/Methods for CIM_HostedCollection (AdminDomain to Collection).....	75
Table 53 - SMI Referenced Properties/Methods for CIM_HostedCollection (ComputerSystem to Collection)	75
Table 54 - SMI Referenced Properties/Methods for CIM_MemberOfCollection.....	75
Table 55 - SMI Referenced Properties/Methods for CIM_NamedAddressCollection.....	76
Table 56 - SMI Referenced Properties/Methods for CIM_ZoneService (Zone Service).....	76
Table 57 - CIM Elements for Zone Control.....	83
Table 58 - SMI Referenced Properties/Methods for CIM_HostedService (Fabric (AdminDomain) to Zone-Service)84	
Table 59 - SMI Referenced Properties/Methods for CIM_HostedService (Switch (ComputerSystem) to ZoneService)84	
Table 60 - SMI Referenced Properties/Methods for CIM_ZoneService (Zone Service).....	84
Table 61 - CIM Elements for FDMI.....	89
Table 62 - SMI Referenced Properties/Methods for CIM_Component (Host Server to Fabric).....	90
Table 63 - SMI Referenced Properties/Methods for CIM_ComputerSystem (Host Server).....	90
Table 64 - SMI Referenced Properties/Methods for CIM_ControlledBy.....	90
Table 65 - SMI Referenced Properties/Methods for CIM_ElementSoftwareIdentity.....	91
Table 66 - SMI Referenced Properties/Methods for CIM_FCPort (Host FCPort).....	91
Table 67 - SMI Referenced Properties/Methods for CIM_HostedCollection (System to LogicalPortGroup).....	92
Table 68 - SMI Referenced Properties/Methods for CIM_InstalledSoftwareIdentity.....	93
Table 69 - SMI Referenced Properties/Methods for CIM_MemberOfCollection (LogicalPortGroup to FCPort) ..	93
Table 70 - SMI Referenced Properties/Methods for CIM_PhysicalPackage (HBA Package).....	93
Table 71 - SMI Referenced Properties/Methods for CIM_PortController.....	94
Table 72 - SMI Referenced Properties/Methods for CIM_Product (HBA Product).....	94
Table 73 - SMI Referenced Properties/Methods for CIM_ProductPhysicalComponent.....	95
Table 74 - SMI Referenced Properties/Methods for CIM_Realizes.....	95
Table 75 - SMI Referenced Properties/Methods for CIM_SoftwareIdentity (Driver).....	96
Table 76 - SMI Referenced Properties/Methods for CIM_SoftwareIdentity (Firmware).....	96
Table 77 - SMI Referenced Properties/Methods for CIM_SoftwareIdentity (Option ROM).....	97
Table 78 - SMI Referenced Properties/Methods for CIM_SystemDevice (ComputerSystem to FCPort).....	97
Table 79 - SMI Referenced Properties/Methods for CIM_SystemDevice (ComputerSystem to PortController) ..	98
Table 80 - CIM Elements for Fabric Views.....	103
Table 81 - SMI Referenced Properties/Methods for CIM_ElementCapabilities (View Capabilities).....	104
Table 82 - SMI Referenced Properties/Methods for CIM_ElementView (View to FC Port).....	104
Table 83 - SMI Referenced Properties/Methods for CIM_ElementView (View to Switch).....	104
Table 84 - SMI Referenced Properties/Methods for CIM_ViewCapabilities.....	105
Table 85 - SMI Referenced Properties/Methods for CIM_ConcreteComponentView (FCSwitchView to Fabric)105	
Table 86 - SMI Referenced Properties/Methods for FC_ConcreteComponentView (FCTopologyView to Fabric)106	

Table 87 - SMI Referenced Properties/Methods for CIM_FCSwitchView	106
Table 88 - SMI Referenced Properties/Methods for CIM_FCTopologyView	108
Table 89 - Supported Profiles for Virtual Fabrics	109
Table 90 - CIM Elements for FabricVirtualFabrics	113
Table 91 - SMI Referenced Properties/Methods for CIM_Component (AdminDomain to Partitioning CS)	113
Table 92 - SMI Referenced Properties/Methods for CIM_ElementConformsToProfile (SAN AdminDomain to Virtual Fabrics RegisteredProfile)114	
Table 93 - Supported Profiles for Switch	115
Table 94 - DetailedPortState for FCPort	119
Table 95 - PortAvailability for FCPort	119
Table 96 - CIM Elements for Switch	121
Table 97 - SMI Referenced Properties/Methods for CIM_ComputerSystem (Partitioned Switch)	122
Table 98 - SMI Referenced Properties/Methods for CIM_ComputerSystem (Switch)	123
Table 99 - SMI Referenced Properties/Methods for CIM_ComputerSystemPackage	125
Table 100 - SMI Referenced Properties/Methods for CIM_ElementCapabilities (FCPort to FCPortCapabilities)125	
Table 101 - SMI Referenced Properties/Methods for CIM_ElementCapabilities (System to FCSwitchCapabilities)125	
Table 102 - SMI Referenced Properties/Methods for CIM_ElementSettingData (FCPortSettings to FCPort).....	126
Table 103 - SMI Referenced Properties/Methods for CIM_ElementSettingData (FCSwitchSettings to ComputerSystem)126	
Table 104 - SMI Referenced Properties/Methods for CIM_ElementStatisticalData (FCPortRateStatistics to FCPort)126	
Table 105 - SMI Referenced Properties/Methods for CIM_ElementStatisticalData (FCPortStatistics to FCPort)127	
Table 106 - SMI Referenced Properties/Methods for CIM_FCPort (Partitioned Switch FCPort)	127
Table 107 - SMI Referenced Properties/Methods for CIM_FCPort (Switch FCPort)	128
Table 108 - SMI Referenced Properties/Methods for CIM_FCPortCapabilities	130
Table 109 - SMI Referenced Properties/Methods for CIM_FCPortRateStatistics	131
Table 110 - SMI Referenced Properties/Methods for CIM_FCPortSettings	131
Table 111 - SMI Referenced Properties/Methods for CIM_FCPortStatistics	132
Table 112 - SMI Referenced Properties/Methods for CIM_FCSwitchCapabilities	134
Table 113 - SMI Referenced Properties/Methods for CIM_FCSwitchSettings	134
Table 114 - SMI Referenced Properties/Methods for CIM_HostedCollection (Redundancy Set)	135
Table 115 - SMI Referenced Properties/Methods for CIM_HostedCollection (Statistics Collection)	135
Table 116 - SMI Referenced Properties/Methods for CIM_MemberOfCollection (FCPort to RedundancySet) ...	136
Table 117 - SMI Referenced Properties/Methods for CIM_MemberOfCollection (NetworkPortStatistics to StatisticalCollection)136	
Table 118 - SMI Referenced Properties/Methods for CIM_ProtocolEndpoint	136
Table 119 - SMI Referenced Properties/Methods for CIM_RedundancySet	137
Table 120 - SMI Referenced Properties/Methods for CIM_StatisticsCollection	137
Table 121 - SMI Referenced Properties/Methods for CIM_SystemDevice	138
Table 122 - CIM Elements for Blades	140
Table 123 - SMI Referenced Properties/Methods for CIM_LogicalModule	141
Table 124 - SMI Referenced Properties/Methods for CIM_ModulePort	141
Table 125 - SMI Referenced Properties/Methods for CIM_PhysicalPackage (Logical Module)	141
Table 126 - SMI Referenced Properties/Methods for CIM_Product (Blade)	142
Table 127 - SMI Referenced Properties/Methods for CIM_ProductPhysicalComponent	142
Table 128 - SMI Referenced Properties/Methods for CIM_Realizes (Logical Module Package)	143
Table 129 - SMI Referenced Properties/Methods for CIM_SystemDevice (Logical Module)	143

Table 130 - Supported Profiles for SwitchPartitioning	145
Table 131 - CIM Elements for SwitchPartitioning	147
Table 132 - SMI Referenced Properties/Methods for CIM_ComputerSystem (Partitioned)	148
Table 133 - SMI Referenced Properties/Methods for CIM_ComputerSystem (Partitioning).....	149
Table 134 - SMI Referenced Properties/Methods for CIM_ElementCapabilities (Association between NetworkPort and NetworkPortCapabilities)149	
Table 135 - SMI Referenced Properties/Methods for CIM_ElementConformsToProfile (Partitioning Computer-System to Switch Partitioning RegisteredProfile)149	
Table 136 - SMI Referenced Properties/Methods for CIM_ElementSettingData (Association between NetworkPort and NetworkPortSettings)150	
Table 137 - SMI Referenced Properties/Methods for CIM_FCPort (Partitioned).....	150
Table 138 - SMI Referenced Properties/Methods for CIM_HostedDependency (NetworkPort to FCPort).....	151
Table 139 - SMI Referenced Properties/Methods for CIM_HostedDependency (Partitioning CS to Partitioned CS)151	
Table 140 - SMI Referenced Properties/Methods for CIM_NetworkPort (Partitioning).....	152
Table 141 - SMI Referenced Properties/Methods for CIM_NetworkPortCapabilities	152
Table 142 - SMI Referenced Properties/Methods for CIM_NetworkPortSettings	153
Table 143 - SMI Referenced Properties/Methods for CIM_SystemDevice (FCPort to Partitioned Computer-System)153	
Table 144 - SMI Referenced Properties/Methods for CIM_SystemDevice (NetworkPort to ComputerSystem)..	153
Table 145 - Supported Profiles for N Port Virtualizer.....	155
Table 146 - CIM Elements for N Port Virtualizer.....	157
Table 147 - SMI Referenced Properties/Methods for CIM_Component (N Port Virtualizer to Fabric).....	158
Table 148 - SMI Referenced Properties/Methods for CIM_ComputerSystem (N Port Virtualizer)	158
Table 149 - SMI Referenced Properties/Methods for CIM_ComputerSystemPackage (N Port Virtualizer to Physical Package)159	
Table 150 - SMI Referenced Properties/Methods for CIM_DeviceSAPImplementation (ProtocolEndpoint to Gateway FCPort)159	
Table 151 - SMI Referenced Properties/Methods for CIM_DeviceSAPImplementation (ProtocolEndpoint to NPIV FCPort)159	
Table 152 - SMI Referenced Properties/Methods for CIM_FCActiveConnection (Gateway)	160
Table 153 - SMI Referenced Properties/Methods for CIM_FCActiveConnection (N Port Virtualization).....	160
Table 154 - SMI Referenced Properties/Methods for CIM_FCPort (Fabric NPIV).....	161
Table 155 - SMI Referenced Properties/Methods for CIM_FCPort (Gateway).....	162
Table 156 - SMI Referenced Properties/Methods for CIM_HostedAccessPoint (N Port Virtualizer System to ProtocolEndpoint)163	
Table 157 - SMI Referenced Properties/Methods for CIM_LogicalIdentity (NPIV Port to Switch Port)	163
Table 158 - SMI Referenced Properties/Methods for CIM_ProtocolEndpoint (N Port Virtualizer).....	163
Table 159 - SMI Referenced Properties/Methods for CIM_SystemDevice (N Port Virtualizer Gateway FCPort to Gateway System)164	
Table 160 - SMI Referenced Properties/Methods for CIM_SystemDevice (N Port Virtualizer NPIV FCPort to Gateway System)164	
Table 161 - CIM Elements for Inter Fabric Routing	169
Table 162 - SMI Referenced Properties/Methods for CIM_Component (Backbone Switch to Fabric)	169
Table 163 - SMI Referenced Properties/Methods for CIM_Component (IFR Switch to Fabric)	170
Table 164 - SMI Referenced Properties/Methods for CIM_ComputerSystem (Backbone Switch).....	170
Table 165 - SMI Referenced Properties/Methods for CIM_ComputerSystem (IFR Switch)	171
Table 166 - SMI Referenced Properties/Methods for CIM_FCActiveConnection	172
Table 167 - SMI Referenced Properties/Methods for CIM_FCPort (IFR FCPort).....	173
Table 168 - SMI Referenced Properties/Methods for CIM_ProtocolEndpoint	174
Table 169 - SMI Referenced Properties/Methods for CIM_SystemDevice.....	175

Table 170 - CIM Elements for FCoE Fabric.....	179
Table 171 - SMI Referenced Properties/Methods for CIM_AdminDomain (Ethernet Network).....	180
Table 172 - SMI Referenced Properties/Methods for CIM_Component (Switch to Ethernet Network)	180
Table 173 - SMI Referenced Properties/Methods for CIM_ComputerSystem (Ethernet Switch)	181
Table 174 - SMI Referenced Properties/Methods for CIM_ConnectivityCollection (LANEndpoints to Ethernet- Network)181	
Table 175 - SMI Referenced Properties/Methods for CIM_DeviceSAPImplementation (Ethernet Switch Ether- netPort to LANEndpoint)182	
Table 176 - SMI Referenced Properties/Methods for CIM_DeviceSAPImplementation (Non-Switch Ethernet- Port to LANEndpoint)182	
Table 177 - SMI Referenced Properties/Methods for CIM_ActiveConnection (Links transported over Ether- net (FCoE))182	
Table 178 - SMI Referenced Properties/Methods for CIM_EthernetPort (Host EthernetPort).....	183
Table 179 - SMI Referenced Properties/Methods for CIM_EthernetPort (Storage EthernetPort))	183
Table 180 - SMI Referenced Properties/Methods for CIM_EthernetPort (Switch EthernetPort))	184
Table 181 - SMI Referenced Properties/Methods for CIM_HostedAccessPoint (AdminDomain to LANEnd- point)184	
Table 182 - SMI Referenced Properties/Methods for CIM_HostedAccessPoint (ComputerSystem to LANEnd- point)185	
Table 183 - SMI Referenced Properties/Methods for CIM_HostedCollection (Ethernet Network AdminDo- main to ConnectivityCollection)185	
Table 184 - SMI Referenced Properties/Methods for CIM_HostedDependency (ComputerSystem (Ethernet Switch) to Partitioning ComputerSystem)186	
Table 185 - SMI Referenced Properties/Methods for CIM_HostedDependency (FCPort to EthernetPort)	186
Table 186 - SMI Referenced Properties/Methods for CIM_LANEndpoint (Ethernet ProtocolEndpoint)	186
Table 187 - SMI Referenced Properties/Methods for CIM_MemberOfCollection (ConnectivityCollection to LANEndpoint)187	
Table 188 - SMI Referenced Properties/Methods for CIM_SystemDevice (Switch EthernetPort to Switch).....	187
Table 189 - SMI Referenced Properties/Methods for CIM_SystemDevice (non-Switch EthernetPort to Ether- net AdminDomain)188	
Table B.1 AdminDomain Properties	193
Table B.2 AdminDomain Associations	194
Table B.3 Switch ComputerSystem Properties	197
Table B.4 Switch ComputerSystem Associations	198
Table B.5 Non-Switch ComputerSystem Properties	201
Table B.6 Non-Switch ComputerSystem Associations	202
Table B.7 Switch FCPort Properties	205
Table B.8 Switch FCPort Associations	206
Table B.9 Non-Switch Port Properties	209
Table B.10 Non-Switch Port Associations	210

FOREWORD

The Fabric Part of the *Storage Management Technical Specification* defines management profiles for Autonomous (top level) profiles for programs and devices whose central function is providing support for storage networking. The Fabric Part includes fabric management including topology and device management for switches. The Fabric part also provides management of extenders that pass fibre channel frames over other protocols as well as a gateway that maps and translates iSCSI to Fibre Channel. As part of fabric management, this specification also has controls for fibre channel zoning and fibre channel security.

Parts of this Standard

This standard is subdivided in the following parts:

- *Storage Management Technical Specification, Part 1 Overview, 1.8.0 Rev 4*
- *Storage Management Technical Specification, Part 2 Common Architecture, 1.8.0 Rev 4*
- *Storage Management Technical Specification, Part 3 Common Profiles, 1.8.0 Rev 4*
- *Storage Management Technical Specification, Part 4 Block Devices, 1.8.0 Rev 4*
- *Storage Management Technical Specification, Part 5 Filesystems, 1.8.0 Rev 4*
- *Storage Management Technical Specification, Part 6 Fabric, 1.8.0 Rev 4*
- *Storage Management Technical Specification, Part 7 Host Elements, 1.8.0 Rev 4*
- *Storage Management Technical Specification, Part 8 Media Libraries, 1.8.0 Rev 4*

SNIA Web Site

Current SNIA practice is to make updates and other information available through their web site at <http://www.snia.org>

SNIA Address

Requests for interpretation, suggestions for improvement and addenda, or defect reports are welcome. They should be sent via the SNIA Feedback Portal at <http://www.snia.org/feedback/> or by mail to the Storage Networking Industry Association, 4360 ArrowsWest Drive, Colorado Springs, Colorado 80907, U.S.A.

1 Scope

The *Storage Management Technical Specification, Part 6 Fabric* defines management profiles for Autonomous (top level) profiles for programs and devices whose central function is providing support for storage networking. This version of *Storage Management Technical Specification, Part 6 Fabric* includes these autonomous profiles:

- Fabric

This profile defines the model and functions of a storage network including topology and zoning control.

- Switch

This profile defines the model and functions of a Fibre Channel Switch including state, status, and control of the device and its connections and product information,

- Extender

This profile defines the model and functions of a networking device that allows for fibre channel to be extended over other networks, and specifically over IP (FCIP).

2 Normative References

The following referenced documents are indispensable for the application of this document. For dated references, only the edition cited applies. For undated references, the latest edition of the referenced document (including any amendments) applies.

2.1 Approved references

ISO/IEC 14776-452 SCSI Primary Commands - 3 (SPC-3) [ANSI INCITS 408-2005]

2.2 References under development

Storage Management Technical Specification, Part 2 Common Architecture, 1.8.0 Rev 4

Storage Management Technical Specification, Part 3 Common Profiles, 1.8.0 Rev 4

2.3 Other references

DMTF DSP1054 Indications Profile 1.2.2

http://www.dmtf.org/sites/default/files/standards/documents/DSP1054_1.2.2.pdf

3 Terms, Definitions, Symbols, Abbreviations, and Conventions

For the purposes of this document, the terms, definitions, symbols, abbreviations, and conventions given in *Storage Management Technical Specification, Part 2 Common Architecture, 1.8.0 Rev 4* apply.

STABLE
4 Fabric Profile**4.1 Synopsis****Profile Name:** Fabric (Autonomous Profile)**Version:** 1.8.0**Organization:** SNIA**Central Class:** AdminDomain**Scoping Class:** AdminDomain**Related Profiles:** Table 1 describes the supported profiles for Fabric.**Table 1 - Supported Profiles for Fabric**

Profile Name	Organization	Version	Requirement	Description
Zone Control	SNIA	1.8.0	Optional	
Enhanced Zoning and Enhanced Zoning Control	SNIA	1.4.0	Optional	
Virtual Fabrics	SNIA	1.5.0	Optional	Experimental.
N Port Virtualizer	SNIA	1.7.0	Optional	Experimental.
FDMI	SNIA	1.8.0	Optional	
Fabric Views	SNIA	1.7.0	Optional	Experimental.
FCoE Fabric	SNIA	1.8.0	Optional	Experimental.
Launch In Context	DMTF	1.0.0	Optional	Experimental. See DSP1102, version 1.0.0
Indications	DMTF	1.2.2	Mandatory	See DSP1054, version 1.2.2

4.2 Description

4.2.1 Instance Diagram

Figure 7: "Fabric Instance" illustrates the basic elements of the Fabric Profile.

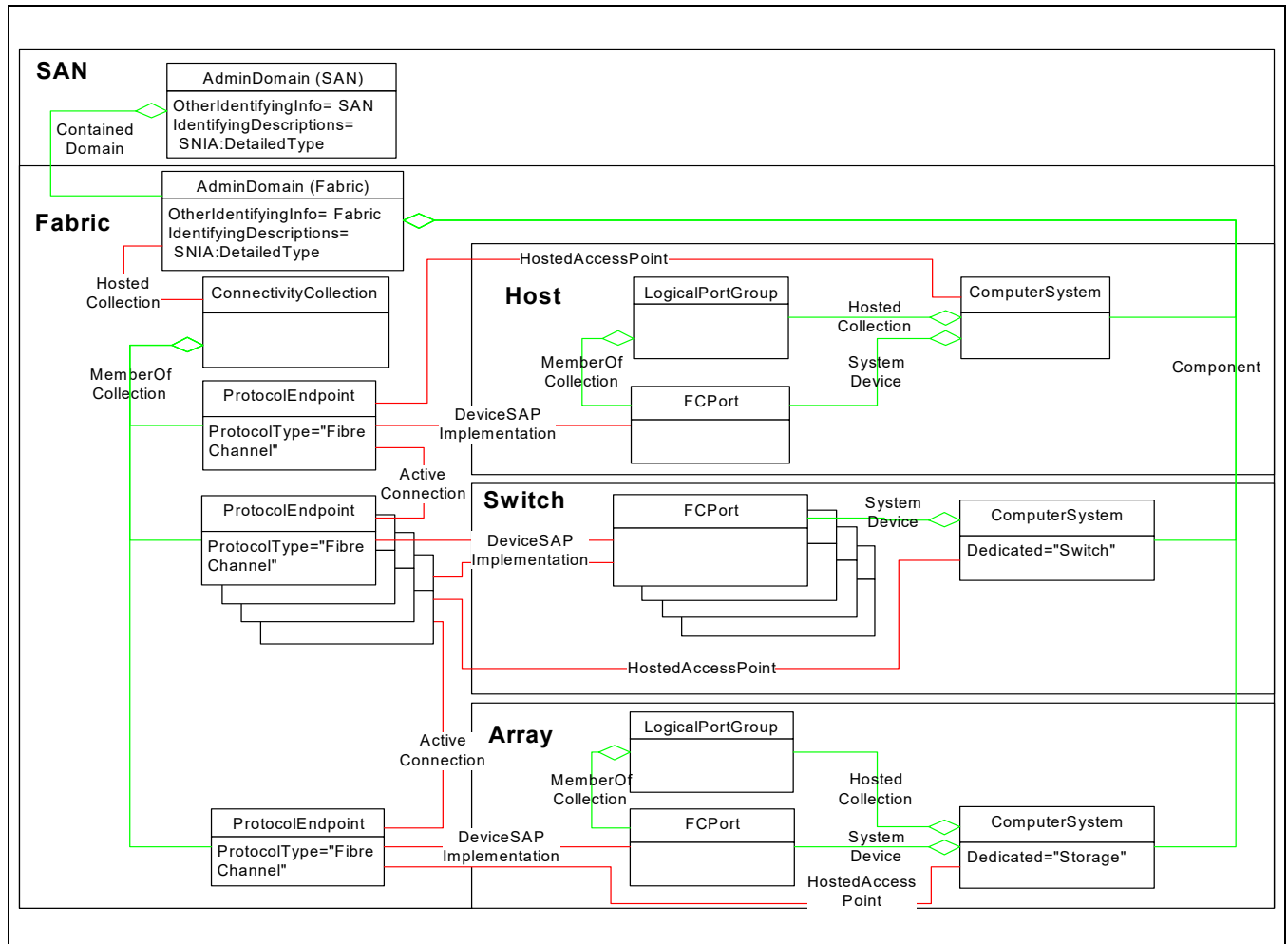

Figure 7 - Fabric Instance

4.2.2 SANS and Fabrics as AdminDomains

A SAN and Fabric are represented in CIM by AdminDomain. A SAN contains one or more Fabrics, which are modeled as AdminDomains. The “containment” of Fabrics to SANs is through the association ContainedDomain. AdminDomain is sub-classed from System. This is significant because a SAN and a Fabric can be considered a group of components that operate together as a single system and should be/are managed as such. The relationship of the Fabrics in a SAN is intended to be able to aggregate all the Fabrics that are in the same physical topology. The possible use cases include: Fibre Channel Virtual Fabrics which have multiple Virtual Fabrics in the same underlying physical topology, Fibre Channel Inter-Fabric Routing which routes Fibre Channel frames between Fabrics, and redundant Fabrics where two physically separate networks connect the same set of hosts and storage.

An AdminDomain in CIM is keyed by the property Name with an associated optional property NameFormat. The naming convention for SANs are left up to the implementation, but the Name shall be correlatable (the same) when multiple agents are managing the same SAN for Virtual Fabric (VF) and Inter-Fabric Routing (IFR).

For Fibre Channel Fabrics, the identifier (AdminDomain.Name) is the Fabric WWN as reported by the fibre channel fabric services. The AdminDomain for the Fibre Channel Fabric shall have a NameFormat of WWN.

4.2.3 Fabrics and Topology

A Fabric in CIM minimally contains a ConnectivityCollection and its component systems. They are associated to the Fabric by the association Component. For the purposes of this discussion, it is assumed one models both.

ConnectivityCollection represents the foundation necessary for routing (and is the reason it is defined in the Network model). A ConnectivityCollection groups a set of ProtocolEndpoints that are able to communicate with each other directly. The ProtocolEndpoint is associated to the ConnectivityCollection by MemberOfCollection. A link is represented by the association ActiveConnection, which associates two ProtocolEndpoints, defined as a connection that is currently carrying traffic or is configured to carry traffic.

It is important at this point to clarify the relationship (or use) of the ProtocolEndpoint versus the use of FCPort (discussed later). A NetworkPort (from which FCPort is subclassed) is the device that is used to represent the logical aspects of the link and data layers. The ProtocolEndpoint is used to represent the higher network layers for routing. This is best understood when thinking about Ethernet and IP, but applies to fibre channel also. When two ProtocolEndpoints are capable of communicating, the association ActiveConnection is used to represent the capability to communicate and completes the picture of the topology.

One can ultimately represent multiple ConnectivityCollections (e.g., FC, IP (over FC), and IP (FC encapsulated in IP) for the same fibre channel fabric.

The minimum set of requirements for this profile is based on FC-GS-6.

4.2.4 Systems and NetworkPorts

As discussed in section 4.2.3, a Port is associated to a device to represent the link layer. A NetworkPort is associated to the ProtocolEndpoint by DeviceSAPImplementation and “joins” the System and Device model to the Network model. Instantiation of DeviceSAPImplementation, ProtocolEndpoint, and ActiveConnection is not necessary if the transceiver is not installed or the cable connecting the port to another port is not installed since the device is not capable of communicating.

Systems, or in this case ComputerSystem, represent the fabric elements that contain Ports. These are typically Hosts, Switches and Storage Systems. In Fibre Channel, these are called Platforms and Interconnect Elements. The property Dedicated in ComputerSystem allows these fabric elements to be identified. For a host, Dedicated is set to “Not Dedicated”, for a switch, Dedicated is set to “Switch”, and for a storage system, Dedicated is set to “Storage”. The Ports on a System are associated by SystemDevice.

Discovery from the viewpoint of the fabric includes the end device, but often times the information available is minimal or not available. In the case of Fibre Channel, this occurs if the platform database is not populated. If this is the case, then discovery cannot tell whether a Fibre Channel Node is contained within the same platform or not. When this occurs, ComputerSystem is not instantiated and the LogicalPortGroup representing the Node and the FCPort are associated to the AdminDomain representing the Fabric.

The instrumentation needs to respond to physical fabric changes by adding or removing Logical elements to the AdminDomain. Adding an element to the fabric is straightforward, however it is not always clear when an element has been removed. The device may have been reset, or temporarily shut down, in which case it would be an element in the fabric with an “unknown” status. The lifetime of objects that can no longer be discovered is implementation specific.

If the instrumentation is unable to determine the type of platform discovered (defined in FC-GS-6), then the agent shall set the ComputerSystem.Dedicated property to "Unknown".

Additional identification information about Switch ComputerSystem (e.g., DomainID) is placed in OtherIdentifyingInfo property.

EXPERIMENTAL

4.2.5 N Port Virtualization (NPIV)

Within a fabric, a host or an N Port Virtualizer can "virtualize" one or more fibre channel ports for each "physical" fibre channel port, known as NPIV. To model NPIV, Figure 7: "Fabric Instance" is extended as shown in Figure 8: "NPIV Instance" with multiple ActiveConnections to the same switch port. The association, HostedDependency, is used to associate the FCPorts representing the "physical" fibre channel port or hosting FCPort with the "virtual" fibre channel ports with the "virtual" port or dependent hosted FCPort.

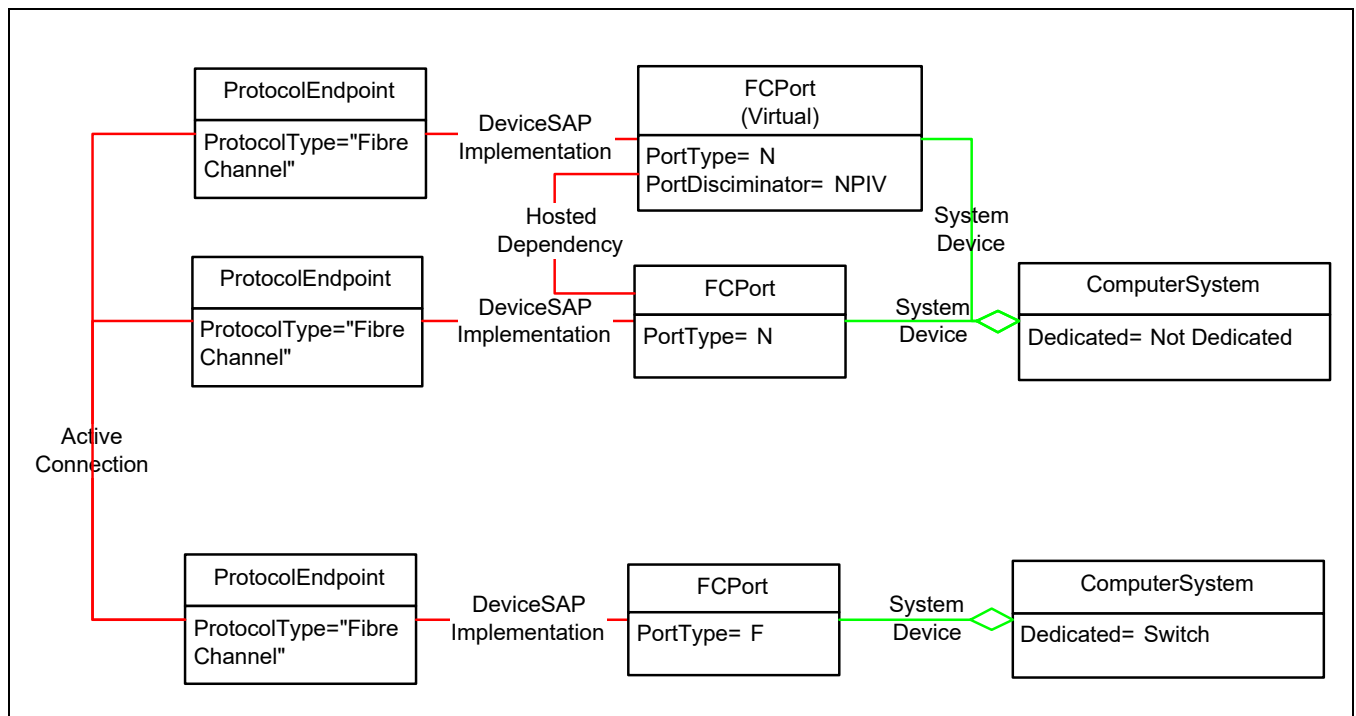

Figure 8 - NPIV Instance

EXPERIMENTAL

4.2.6 Zoning

4.2.6.1 Basic Model for Zoning

Figure 9 illustrates the basic model for zoning

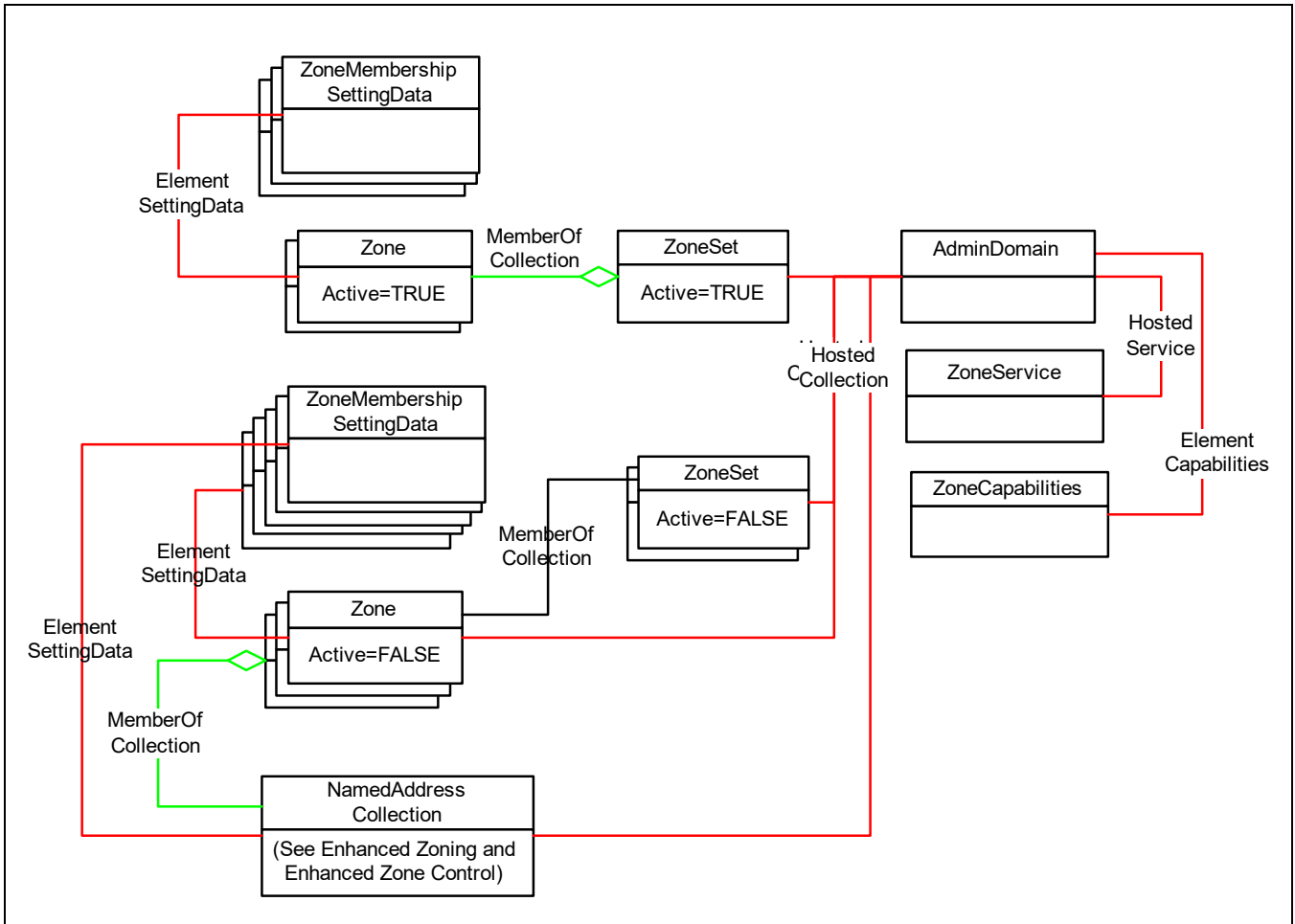

Figure 9 - Zoning Instance (AdminDomain)

EXPERIMENTAL

The zoning model is based on FC-GS-7.

EXPERIMENTAL

This model represents the management model for defining Zone Sets, Zones, and Zone Members and “activation” of a Zone Set for a fabric. In the following discussion it may be helpful to also define the following:

- **Active ZoneSet:** the Zone Set currently enforced by the Fabric.
- **Zone Set Database:** The database of the Zone Sets not enforced by the Fabric. Referred to in this document as the Inactive Zone Sets.

Basic Model for Zoning

- **Zoning Definitions:** a generic term used to indicate both the above concepts.

The zoning model refers to a Zone Set as ZoneSet, a Zone as Zone, ZoneAlias as a NamedAddressCollection, and Zone Member as ZoneMembershipSettingData. ZoneSets shall only contain Zones associated by MemberOfCollection. Zones shall only contain ZoneMembershipSettingData associated by ElementSettingData (except for peer zones, see 4.2.6.2 Peer Zoning for more information) or NamedAddressCollections associated by MemberOfCollection. For more information with regards to NamedAddressCollection, see 5 Enhanced Zoning and Enhanced Zone Control Profile.

The class ZoneMembershipSettingData has two properties that indicate how the device was identified to be “zoned”. They are ConnectivityMemberType (e.g., PermanentAddress for WWN, NetworkAddress for FCID, etc.) and ConnectivityMemberID which contains the actual device identifier.

The Active Zone Set, defined by an instance of ZoneSet with the Active property set to TRUE, shall only be hosted on the AdminDomain representing the Fabric. The Inactive Zone Sets, defined by an instance of ZoneSet with the Active property set to FALSE, shall be hosted on either the AdminDomain representing the Fabric as shown in Figure 9: "Zoning Instance (AdminDomain)" or the ComputerSystem representing the switch as shown in Figure 10: "Zoning Instance (ComputerSystem)". It is allowed to have no ZoneSets (active or inactive), only an active ZoneSet, only an inactive ZoneSet(s), or both an inactive ZoneSet(s) and an active ZoneSet.

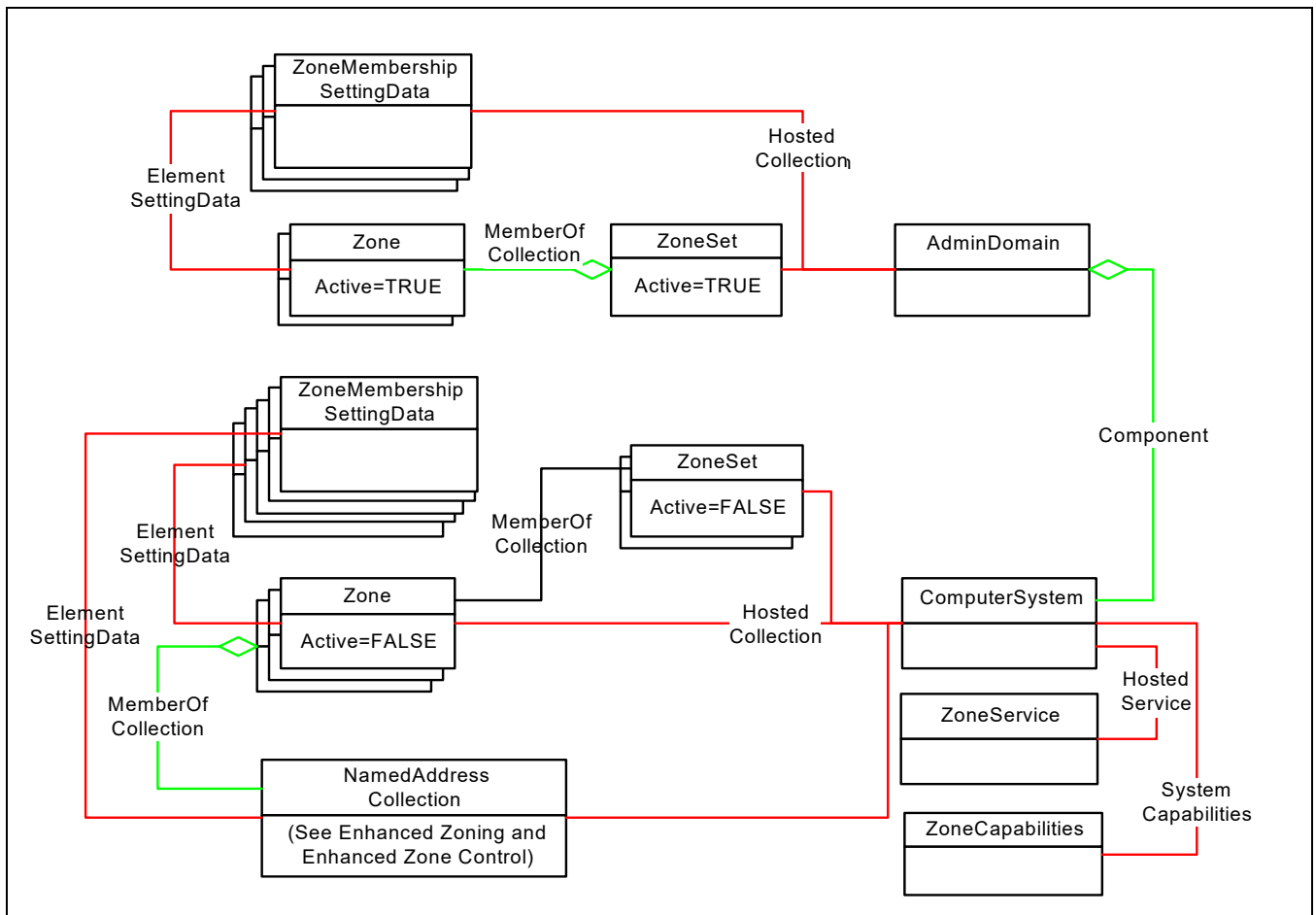

Figure 10 - Zoning Instance (ComputerSystem)

The ZoneService and ZoneCapabilities are also associated to the same System (AdminDomain or ComputerSystem) as the Inactive Zone Sets using the association HostedService or ElementCapabilities, respectively.

Peer Zoning

ZoneService provides the configuration methods to control create ZoneSets, Zones, Zone Aliases, and Zone Members, as well as activation of the Zone Set. This service and its methods are described in the 5 Enhanced Zoning and Enhanced Zone Control Profile.

EXPERIMENTAL

4.2.6.2 Peer Zoning

For peer zones, there are zone members identified as either a principal member or peer member. The semantics of a peer zone is that peer members are allowed to communicate with the principal member; and Peer members are not allowed to communicate among themselves (unless allowed by other Zones in the Zone Set). The addition in the model to for peer zones is that ZoneMembershipSettingData is associated to the Zone with the association ZoneSettingData which has an addition property, ZoneMembershipRole, to identify whether the member is a principal or peer.

Traditionally, SAN zoning has been wholly owned and controlled by switches in the fabric and administered through a management interface (e.g. SMI). There is an additional mechanism where a target can, in band, create peer zones, commit, and enable them in the fabric. For the purposes of this document, these peer zones will be called peer target zones. Otherwise (those create through a management interface), will be call peer user zones. The property ZoneType in the class Zone is used to identify the mechanism it was created with.

Figure 11 illustrates peer zoning.

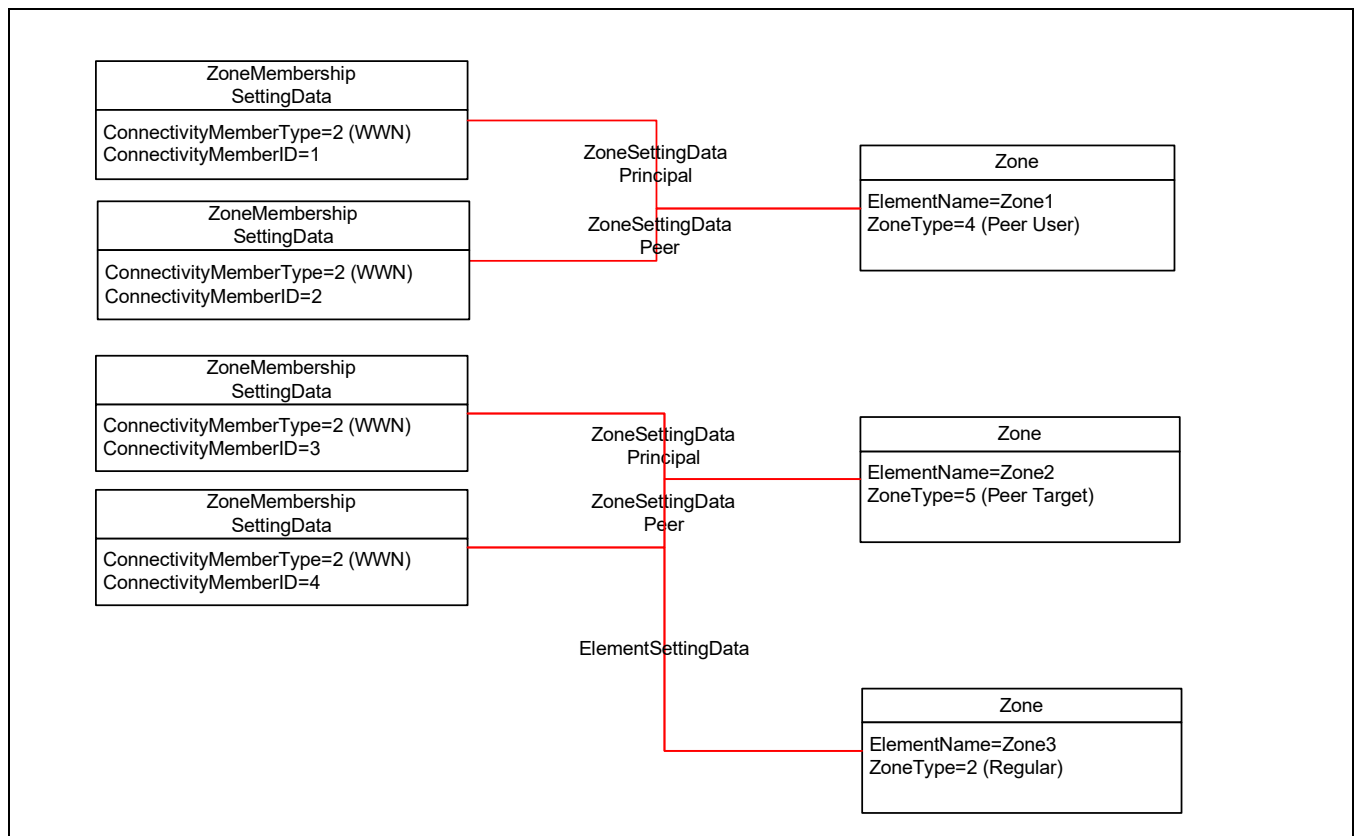

Figure 11 - Zoning Instance (Peer Zoning)

EXPERIMENTAL

EXPERIMENTAL

4.2.7 Conditional Classes and Properties

Table 4 contains some classes which are conditional on implementation of other profiles in the Fabric Book:

- CIM_ComputerSystem (Partitioned Switch) is conditional on the implementation of the Virtual Fabrics component profile
- CIM_FCPort (Partitioned Switch FCPort) is conditional on the implementation of the Switch Partitioning component profile

In addition, some of the mandatory classes of the Fabric Profile include properties that are conditional on the implementation of other profiles in the Fabric book.

- Some properties in CIM_ComputerSystem (Switch) are conditional on the implementation of the Switch Profile.
- Some properties in CIM_FCPort (Switch FCPort) are conditional on the implementation of the Switch Profile

EXPERIMENTAL

4.3 Health and Fault Management

The following classes report possible Health and Fault information through LifeCycle indications:

- ComputerSystem,
- FCPort

These LifeCycle indications are more fully described in Table 4, "CIM Elements for Fabric,".

Also in Table 4, "CIM Elements for Fabric," is a list of AlertIndications which may also be indicators for Health and Fault Management.

4.4 Cascading Considerations

Not defined in this document

4.5 Methods of this Profile

4.5.1 Extrinsic Methods of the Profile

All of the Fabric Profile extrinsic methods return one of the following status codes. Depending on the error condition, a method may return additional error codes and/or throw an appropriate exception to indicate the error encountered.

0: Success

1: Not Supported

2: Unspecified Error

3: Timeout

4: Failed

5: Invalid Parameter

Peer Zoning

6: Access_Denied

7: Not_Found (not applicable for SessionControl)

8: Already_Exists (Not applicable for ActivateZoneSet and SessionControl)

9: Insufficient_Resources

4.5.2 CreateZoneSet

This method creates a ZoneSet and the association HostedCollection. The newly created association, HostedCollection, associates the Zone to the same AdminDomain (Fabric) that the ZoneService is hosted to. For the newly created ZoneSet, the Active property is always set to false.

```

CreateZoneSet(
    [Required, IN, Description (
        "A user-friendly name for the ZoneSet that is "
        "unique within the AdminDomain." ),
        ModelCorrespondence { "CIM_ZoneSet.ElementName" }]
    string ZoneSetName,
    [IN, OUT, Description (
        "A reference to the newly created Zone." )]
    CIM_ZoneSet REF ZoneSet);

```

4.5.3 CreateZone

This method creates a Zone and the association HostedCollection. The newly created association, HostedCollection, associates the Zone to the same AdminDomain (Fabric) that the ZoneService is hosted to. For the newly created Zone, the Active property is always set to false.

```

CreateZone(
    [Required, IN, Description (
        "A user-friendly name for the Zone that is unique "
        "within the AdminDomain." ),
        ModelCorrespondence { "CIM_Zone.ElementName" }]
    string ZoneName,
    [IN, Description ( "The type of zoning to be enforced." ),
        ValueMap { "2", "3" },
        Values { "Default", "Protocol" },
        ModelCorrespondence { "CIM_Zone.ZoneType" }]
    uint16 ZoneType,
    [IN, Description (
        "Specific clarification to be used when the "
        "ZoneType has an enumeration that requires it. "
        "Specifically, if ZoneType is \"Protocol\", then "
        "SubType is the Fibre Channel FC4 type." ),
        ValueMap { "2", "3", "4" },
        Values { "SCSI", "VI", "IP" },
        ModelCorrespondence { "CIM_Zone.ZoneSubType" }]
    uint16 ZoneSubType,
    [IN, OUT, Description (
        "A reference to the newly created Zone." )]
    CIM_Zone REF Zone);

```

4.5.4 CreateZoneAlias

This method creates a ZoneAlias and the association HostedCollection. The newly created association, HostedCollection, associates the ZoneAlias to the same AdminDomain (Fabric) that the ZoneService is hosted to. For the newly created ZoneAlias, the Active property is always set to false.

```
CreateZoneAlias(
    [Required, IN, Description (
        "A name (alias) for the ZoneAlias that is unique in "
        "the context of the hosting System." ),
    ModelCorrespondence { "CIM_ZoneAlias.CollectionAlias" }]
    string CollectionAlias,
    [IN, OUT, Description (
        "A reference to the newly created ZoneAlias." )]
    CIM_NamedAddressCollection REF ZoneAlias);
```

4.5.5 CreateZoneMembershipSettingData

This method creates a ZoneMembershipSettingData instance and adds it to the specified Zone or ZoneAlias by creating a MemberOfCollection association.

```
CreateZoneMembershipSettingData(
    [Required, IN, Description (
        "Identifies the type of identification placed in "
        "ConnectivityMemberID." ),
    ValueMap { "0", "1", "2", "3", "4", "5", "..",
        "0x8000.." },
    Values { "Unknown", "Other", "PermanentAddress",
        "NetworkAddress", "SwitchPortID",
        "LogicalPortGroup", "DMTF_Reserved",
        "Vendor_Reserved" },
    ModelCorrespondence {
        "CIM_ZoneMembershipSettingData.ZoneMemberType" }]
    uint16 ConnectivityMemberType,
    [Required, IN, Description (
        "This property specifies the type of identification "
        "used in the ConnectivityMemberID field. For Fibre "
        "Channel: \n"
        "* A ConnectivityMemberType of \'PermanentAddress\', "
        "the ConnectivityMemberID is the NxPort WWN; \n"
        "* A ConnectivityMemberType of \'NetworkAddress\', "
        "the ConnectivityMemberID is the NXPort Address ID; \n"
        "* A ConnectivityMemberType of \'SwitchPortID\', "
        "the ConnectivityMemberID is \'Domain:PortNumber\'. " ),
    ModelCorrespondence {
        "CIM_ZoneMembershipSettingData.ConnectivityMemberID" }]
    string ConnectivityMemberID,
    [Required, IN, Description (
        "The collection that the ZoneMembershipSettingData "
        "should be added to. The collection is either a "
```

Peer Zoning

```

    "Zone or ZoneAlias." )]
CIM_SystemSpecificCollection REF SystemSpecificCollection,
    [IN, OUT, Description (
        "A reference to the newly created ZoneMembershipSettingData."
    )]
CIM_ZoneMembershipSettingData REF ZoneMembershipSettingData)

```

4.5.6 AddZone

This method adds to the specified ZoneSet the specified Zone. Adding a Zone to a ZoneSet, extends the zone enforcement definition of the ZoneSet to include the members of that Zone. If adding the Zone is successful, the Zone should be associated with the ZoneSet by MemberOfCollection.

```

AddZone(
    [Required, IN, Description (
        "A reference to the ZoneSet that the Zone is added to."
    )]
CIM_ZoneSet REF ZoneSet,
    [IN, Description (
        "A reference to the Zone that is to be added to the ZoneSet."
    )]
CIM_Zone REF Zone)

```

4.5.7 AddZoneMembershipSettingData

This method adds to the specified Zone or ZoneAlias, the specified ZoneMembershipSettingData. If adding the ZoneMembershipSettingData is successful, an ElementSettingData association will be created between the ZoneMembershipSettingData and either the Zone or ZoneAlias.

```

AddZoneMembershipSettingData(
    [Required, IN, Description (
        "A reference to the Zone or ZoneAlias that the "
        "ZoneMembershipSettingData is to be added to." )]
CIM_SystemSpecificCollection REF SystemSpecificCollection,
    [IN, Description (
        "A reference to the ZoneMembershipSettingData that "
        "is to be added to the Zone or ZoneAlias." )]
CIM_ZoneMembershipSettingData REF ZoneMembershipSettingData)

```

4.5.8 AddZoneAlias

This method adds to the specified Zone the specified NamedAddressCollection (ZoneAlias). If adding the NamedAddressCollection (ZoneAlias) is successful, an ElementSettingData association will be created between the NamedAddressCollection and either the Zone or ZoneAlias.

```

AddZoneAlias(
    [Required, IN, Description (
        "A reference to the Zone that the ZoneAlias is to be added to."
    )]
CIM_Zone REF Zone,
    [IN, Description (
        "A reference to the ZoneAlias that is to be added to the Zone."
    )]

```

Peer Zoning

```
CIM_NamedAddressCollection REF ZoneAlias)
```

4.5.9 ActivateZoneSet

This method activates the specified ZoneSet. After the ZoneSet is activated, the ZoneSet, associated Zone, NamedAddressCollection (ZoneAliases), and ZoneMembershipSettingData instances will have the active flag set to true.

```
ActivateZoneSet(
    [Required, IN, Description (
        "A reference to the ZoneSet to be activated." )]
    CIM_ZoneSet REF ZoneSet,
    [Required, IN, Description (
        "Activate indicates whether the references to "
        "ZoneSet should be activated (Active=true) or "
        "deactivated (Active=false)." )]
    boolean Activate)
```

4.5.10 SessionControl

This method requests that a session start (value=2), end (value=3), or terminate (value=4). SessionControl is used in zoning to group a set of zoning tasks (CreateZoneSet, CreateZone, CreateZoneAlias, CreateZoneMembershipSettingData, AddZone, AddZoneMemberSettingData, AddZoneAlias) together as a transaction (start) and when completed (end) to be applied (end) or can be dropped (terminated).

```
uint32 SessionControl(
    [IN, Description (
        "RequestedSessionState is an integer enumeration "
        "that indicates whether the ZoneService session has "
        "been requested to start (value=2), end (value=3), "
        "or terminate (value=4)." )],
    ValueMap { "2", "3", "4" },
    Values { "Start", "End", "Terminate" },
    ModelCorrespondence {
        "CIM_ZoneService.RequestedSessionState" }]
    uint16 RequestedSessionState)
```

4.6 Use Cases**4.6.1 Fabric Identifier**

The client needs to consider that the fabric identifier is not durable but is correlatable and may change over time. See *Storage Management Technical Specification, Part 2 Common Architecture, 1.8.0 Rev 4 7* Correlatable and Durable Names.

4.6.2 FCPort OperationalStatus

OperationalStatus is the property to indicate status and state for the FCPort (both Platform and Switch ports). The FCPort instance has one of the following Operational Statuses.

Table 2 - Port OperationalStatus

OperationalStatus	Description
OK	Port is online
Error	Port has a failure
Stopped	Port is disabled
InService	Port is in Self Test
Unknown	

4.6.3 Switch ComputerSystem OperationalStatus

OperationalStatus is the property to indicate status and state for switch ComputerSystems. The switch ComputerSystem instance has one of the following Operational Statuses and possibly one of the Subsidiary statuses.

Table 3 - OperationalStatus for ComputerSystem

Operational Status	Possible Subsidiary Operational Status	Description
OK		The system has a good status
OK	Stressed	The system is stressed, for example the temperature is over limit or there is too much IO in progress
OK	Predictive Failure	The system will probably will fail sometime soon
Degraded		The system is operational but not at 100% redundancy. A component has suffered a failure or something is running slow
Error		An error has occurred causing the system to stop. This error may be recoverable with operator intervention.
Error	Non-recoverable error	A severe error has occurred. Operator intervention is unlikely to fix it
Error	Supporting entity in error	A modeled element has failed
InService		Switch is in Self Test.
No contact		The provider knows about the array but has not talked to it since last reboot
Lost communication		The provider used to be able to communicate with the array, but has now lost contact.
Starting		The system is starting up
Stopping		The system is shutting down.
Stopped		The data path is OK but shut down, the management channel is still working.

4.7 CIM Elements

4.7.1 Overview

Table 4 describes the CIM elements for Fabric.

Table 4 - CIM Elements for Fabric

Element Name	Requirement	Description
4.7.2 CIM_ActiveConnection	Mandatory	The association between ProtocolEndpoints representing the links between devices.
4.7.3 CIM_AdminDomain (Fabric)	Mandatory	AdminDomain representing the Fabric. Associated to RegisteredProfile.
4.7.4 CIM_AdminDomain (SAN)	Mandatory	AdminDomain representing the SAN.
4.7.5 CIM_Component (Platform to Fabric)	Optional	Aggregates Hosts and Arrays (Platforms) in the AdminDomain that represents the Fabric.
4.7.6 CIM_Component (Switch to Fabric)	Mandatory	Aggregates Switches in the AdminDomain that represents the Fabric.
4.7.7 CIM_ComputerSystem (Host Platform)	Mandatory	The ComputerSystem representing the Host Platform.
4.7.8 CIM_ComputerSystem (Partitioned Switch)	Conditional	Conditional requirement: Required if the Virtual Fabrics profile is implemented. The ComputerSystem representing a Partitioned Switch.
4.7.9 CIM_ComputerSystem (Storage Platform)	Mandatory	The ComputerSystem representing the Storage Platform (e.g. an Array).
4.7.10 CIM_ComputerSystem (Switch)	Mandatory	The ComputerSystem representing the Switch.
4.7.11 CIM_ConnectivityCollection	Mandatory	Collects the ProtocolEndpoints of the fabric.
4.7.12 CIM_ContainedDomain	Mandatory	Associates a Fabric to a SAN.
4.7.13 CIM_DeviceSAPImplementation (Non-Switch to FCPort)	Mandatory	Associates the Non-Switch (Host or Storage) FCPort to the ProtocolEndpoint.
4.7.14 CIM_DeviceSAPImplementation (Switch to FCPort)	Mandatory	Associates the Switch FCPort to the ProtocolEndpoint.
4.7.15 CIM_ElementCapabilities (ZoneCapabilities to Fabric.)	Mandatory	Associates ZoneCapabilities to a Fabric.
4.7.16 CIM_ElementCapabilities (ZoneCapabilities to Switch.)	Mandatory	Associates ZoneCapabilities to a switch system.
4.7.17 CIM_ElementSettingData (ZoneMembershipSettingData to Zone)	Mandatory	Associates ZoneMembershipSettingData to the Zone.
4.7.18 CIM_FCActiveConnection	Optional	Experimental. The association between ProtocolEndpoints representing the links between fibre channel devices (including ISLs).
4.7.19 CIM_FCPort (Host FCPort)	Mandatory	Fibre Channel Port for Host Platforms.
4.7.20 CIM_FCPort (Host NPIV FCPort)	Optional	Experimental. A Host NPIV Fibre Channel Port for Host Platforms.
4.7.21 CIM_FCPort (Partitioned Switch FCPort)	Conditional	Conditional requirement: Support for the Switch Partitioning profile. Fibre Channel Port for Partitioned Switch.
4.7.22 CIM_FCPort (Storage FCPort)	Mandatory	Fibre Channel Port for Devices (Storage Platforms).
4.7.23 CIM_FCPort (Switch FCPort)	Mandatory	Fibre Channel Port for Switch.

Peer Zoning

Table 4 - CIM Elements for Fabric

Element Name	Requirement	Description
4.7.24 CIM_HostedAccessPoint (AdminDomain to ProtocolEndpoint)	Optional	Associates the ProtocolEndpoint to a Fabric AdminDomain.
4.7.25 CIM_HostedAccessPoint (ComputerSystem to ProtocolEndpoint)	Mandatory	Associates the ProtocolEndpoint to the hosting ComputerSystem.
4.7.26 CIM_HostedCollection (Fabric to ConnectivityCollection)	Mandatory	Associates the ConnectivityCollection to the AdminDomain representing the Fabric.
4.7.27 CIM_HostedCollection (System to LogicalPortGroup)	Mandatory	Associates the LogicalPortGroup to the ComputerSystem representing the platform (host or array) or the Fabric (if platforms are not implemented).
4.7.28 CIM_HostedCollection (Zones or ZoneSets to Fabric)	Mandatory	Associates the ZoneSets and Zones to the AdminDomain representing the Fabric.
4.7.29 CIM_HostedCollection (Zones or ZoneSets to Switch)	Mandatory	Associates the ZoneSets and Zones to the hosting System (the ComputerSystem representing the switch).
4.7.30 CIM_HostedDependency	Optional	Experimental. The association representing the relationship of the FCPort that hosts the FCPorts that are virtualized.
4.7.31 CIM_LogicalPortGroup	Mandatory	Fibre Channel Node.
4.7.32 CIM_MemberOfCollection (ConnectivityCollection to ProtocolEndpoint)	Mandatory	Associates ConnectivityCollection to ProtocolEndpoint.
4.7.33 CIM_MemberOfCollection (LogicalPortGroup to FCPort)	Mandatory	Associates a LogicalPortGroup to its platform FC Ports.
4.7.34 CIM_MemberOfCollection (ZoneSet to Zone)	Mandatory	Associates a ZoneSet to its Zones.
4.7.35 CIM_ProtocolEndpoint	Mandatory	The endpoint of a link (ActiveConnection).
4.7.36 CIM_SystemDevice (Non-Switch FCPort to Fabric)	Optional	Associates non-Switch FCPorts to the System (Fabric).
4.7.37 CIM_SystemDevice (Non-Switch FCPort to Platform)	Optional	Associates non-Switch FCPorts to the ComputerSystem (Platform).
4.7.38 CIM_SystemDevice (Switch FCPort to Switch)	Mandatory	Associates Switch FCPorts to the ComputerSystem (Switch).
4.7.39 CIM_Zone (Active)	Mandatory	The active Zones being enforced by the Fabric.
4.7.40 CIM_Zone (Inactive)	Mandatory	The inactive Zones being enforced by the Fabric.
4.7.41 CIM_ZoneCapabilities	Mandatory	The Zoning Capabilities of the associated Fabric (or Switch).
4.7.42 CIM_ZoneMembershipSettingData	Mandatory	Defines the zone member.
4.7.43 CIM_ZoneSet (Active)	Mandatory	The active ZoneSets being enforced by the Fabric.
4.7.44 CIM_ZoneSet (Inactive)	Mandatory	The inactive ZoneSet.
4.7.45 CIM_ZoneSettingData (ZoneMembershipSettingData to Zone)	Conditional	Experimental. Conditional requirement: Required if the CIM_ZoneCapabilities.PeerZoningSupported='4' (Peer User) or '5' (Peer Target). Associates ZoneMembershipSettingData to the Zone with the peer zone role.
SELECT * FROM CIM_InstCreation WHERE SourceInstance ISA CIM_ComputerSystem	Mandatory	Creation of a ComputerSystem instance..
SELECT * FROM CIM_InstDeletion WHERE SourceInstance ISA CIM_ComputerSystem	Mandatory	Deletion of a ComputerSystem instance.

Table 4 - CIM Elements for Fabric

Element Name	Requirement	Description
SELECT * FROM CIM_InstCreation WHERE SourceInstance ISA CIM_FCPort	Mandatory	Creation of a FC Port instance.
SELECT * FROM CIM_InstDeletion WHERE SourceInstance ISA CIM_FCPort	Mandatory	Deletion of a FC Port instance.
SELECT * FROM CIM_InstModification WHERE SourceInstance ISA CIM_FCPort AND SourceInstance.CIM_FCPort::OperationalStatus <> PreviousInstance.CIM_FCPort::OperationalStatus	Mandatory	CQL -Modification of OperationalStatus of a FC Port instance.
SELECT * FROM CIM_InstModification WHERE SourceInstance ISA CIM_ComputerSystem AND SourceInstance.CIM_ComputerSystem::OperationalStatus <> PreviousInstance.CIM_ComputerSystem::OperationalStatus	Mandatory	CQL -Modification of OperationalStatus of a ComputerSystem instance.
SELECT * FROM CIM_AlertIndication WHERE OwningEntity='SNIA' and MessageID='FC1'	Mandatory	CQL -Modification of Zone Database.
SELECT * FROM CIM_AlertIndication WHERE OwningEntity='SNIA' and MessageID='FC2'	Mandatory	CQL -ZoneSet Activated.
SELECT * FROM CIM_AlertIndication WHERE OwningEntity='SNIA' and MessageID='FC5'	Mandatory	Experimental. Switch Status Changed.
SELECT * FROM CIM_AlertIndication WHERE OwningEntity='SNIA' and MessageID='FC6'	Mandatory	Experimental. Fabric Merge/Segmentation.
SELECT * FROM CIM_AlertIndication WHERE OwningEntity='SNIA' and MessageID='FC7'	Mandatory	Experimental. Switch Added/Removed.
SELECT * FROM CIM_AlertIndication WHERE OwningEntity='SNIA' and MessageID='FC8'	Mandatory	Experimental. Fabric Added/Removed.

4.7.2 CIM_ActiveConnection

The association between ProtocolEndpoints representing the links between devices (including ISLs). For loops, multiple ActiveConnections are instantiated as one to many relationships.

Created By: Static

Modified By: Static

Deleted By: Static

Requirement: Mandatory

Table 5 describes class CIM_ActiveConnection.

Table 5 - SMI Referenced Properties/Methods for CIM_ActiveConnection

Properties	Flags	Requirement	Description & Notes
Antecedent		Mandatory	The reference to the ProtocolEndpoint for one end of the link.
Dependent		Mandatory	The reference to the ProtocolEndpoint for the other end of the link.

4.7.3 CIM_AdminDomain (Fabric)

AdminDomain representing the fabric. This is a logical entity and can represent virtual fabrics.

Peer Zoning

Note that if the Virtual Fabrics Profile is implemented, OtherIdentifyingInfo shall contain a Virtual Fabric ID with a 'SNIA:VF_ID' in the corresponding index of IdentifyingDescriptions.

Created By: Static

Modified By: Static

Deleted By: Static

Requirement: Mandatory

Shall be associated to RegisteredProfile using ElementConformsToProfile association. The RegisteredProfile instance shall have RegisteredName set to 'Fabric', RegisteredOrganization set to 'SNIA', and RegisteredVersion set to '1.8.0'.

Table 6 describes class CIM_AdminDomain (Fabric).

Table 6 - SMI Referenced Properties/Methods for CIM_AdminDomain (Fabric)

Properties	Flags	Requirement	Description & Notes
CreationClassName		Mandatory	Name of Class.
Name	C	Mandatory	WWN of Fabric.
NameFormat		Mandatory	Shall be 'WWN'.
ElementName		Optional	A user friendly name for the Fabric (implementation dependent).
OtherIdentifyingInfo		Mandatory	For a Fabric AdminDomain this property shall contain the value 'Fabric'. For Virtual Fabrics, one of the indices shall contain the value of the Virtual Fabric ID and in the corresponding index for OtherIdentifyingDescription the value 'SNIA:VF_ID'.
IdentifyingDescriptions		Mandatory	For a Fabric AdminDomain this property shall contain the value 'SNIA:DetailedType' in the index for the OtherIdentifyingInfo of 'Fabric'. For Virtual Fabrics, One of the indices shall contain the value 'SNIA:VF_ID' and in the corresponding index for OtherIdentifyingInfo the value of the Virtual Fabric ID.

4.7.4 CIM_AdminDomain (SAN)

AdminDomain representing the SAN.

Created By: Static

Modified By: Static

Deleted By: Static

Requirement: Mandatory

Table 7 describes class CIM_AdminDomain (SAN).

Table 7 - SMI Referenced Properties/Methods for CIM_AdminDomain (SAN)

Properties	Flags	Requirement	Description & Notes
CreationClassName		Mandatory	Name of Class.
Name		Mandatory	An arbitrary name (implementation dependent).
NameFormat		Mandatory	Dependent on the arbitrary name chosen.

Table 7 - SMI Referenced Properties/Methods for CIM_AdminDomain (SAN)

Properties	Flags	Requirement	Description & Notes
ElementName		Optional	A user friendly name for the SAN (implementation dependent).
OtherIdentifyingInfo		Mandatory	For a SAN AdminDomain this property shall contain the value 'SAN'.
IdentifyingDescriptions		Mandatory	For a SAN AdminDomain this property shall contain the value 'SNIA:DetailedType' in the index for the OtherIdentifyingInfo of 'SAN'.

4.7.5 CIM_Component (Platform to Fabric)

Aggregates Hosts and Arrays (Platforms) in the AdminDomain that represents the Fabric.

Created By: Static

Modified By: Static

Deleted By: Static

Requirement: Optional

Table 8 describes class CIM_Component (Platform to Fabric).

Table 8 - SMI Referenced Properties/Methods for CIM_Component (Platform to Fabric)

Properties	Flags	Requirement	Description & Notes
PartComponent		Mandatory	Reference to a Storage Platform or Host Platform ComputerSystem.
GroupComponent		Mandatory	Reference to the AdminDomain representing the Fabric (OtherIdentifyingInfo contains 'Fabric' with a corresponding 'SNIA:DetailedType' in IdentifyingDescriptions).

4.7.6 CIM_Component (Switch to Fabric)

Aggregates Switches in the AdminDomain that represents the Fabric.

Created By: Static

Modified By: Static

Deleted By: Static

Requirement: Mandatory

Table 9 describes class CIM_Component (Switch to Fabric).

Table 9 - SMI Referenced Properties/Methods for CIM_Component (Switch to Fabric)

Properties	Flags	Requirement	Description & Notes
PartComponent		Mandatory	Reference to Switch (a ComputerSystem with Dedicated='5').
GroupComponent		Mandatory	Reference to the AdminDomain representing the Fabric (OtherIdentifyingInfo contains 'Fabric' with a corresponding 'SNIA:DetailedType' in IdentifyingDescriptions).

4.7.7 CIM_ComputerSystem (Host Platform)

The ComputerSystem representing the Host Platform. This class is typically instantiated if the end device has populated the Fibre Channel Platform Database or FDMI.

Peer Zoning

Created By: Static
 Modified By: Static
 Deleted By: Static
 Requirement: Mandatory

Table 10 describes class CIM_ComputerSystem (Host Platform).

Table 10 - SMI Referenced Properties/Methods for CIM_ComputerSystem (Host Platform)

Properties	Flags	Requirement	Description & Notes
CreationClassName		Mandatory	Name of Class.
Name	C	Mandatory	The Platform Name or FDMI Host Name.
ElementName		Mandatory	The Platform Label.
NameFormat		Mandatory	
Dedicated		Mandatory	For a FC-GS Platform Type of Host, this shall be 'Not Dedicated' (0) or 'Unknown' (1).

4.7.8 CIM_ComputerSystem (Partitioned Switch)

The ComputerSystem representing a Partitioned Switch. This is a constrained case of the Switch ComputerSystem. Instance of a Partitioned Switch shall have an entry of 'Virtual Switch' and an entry for the Virtual Fabric ID in the OtherIdentifyingInfo array property (as well as the DomainID for the Switch).

Created By: Static
 Modified By: Static
 Deleted By: Static
 Requirement: Required if the Virtual Fabrics profile is implemented.

Table 11 describes class CIM_ComputerSystem (Partitioned Switch).

Table 11 - SMI Referenced Properties/Methods for CIM_ComputerSystem (Partitioned Switch)

Properties	Flags	Requirement	Description & Notes
CreationClassName		Mandatory	See the CreationClassName definition in section 4.7.10 CIM_ComputerSystem (Switch).
Name	C	Mandatory	See the Name definition in section 4.7.10 CIM_ComputerSystem (Switch).
ElementName		Mandatory	See the ElementName definition in section 4.7.10 CIM_ComputerSystem (Switch).
NameFormat		Mandatory	See the NameFormat definition in section 4.7.10 CIM_ComputerSystem (Switch).
OperationalStatus		Mandatory	See the OperationalStatus definition in section 4.7.10 CIM_ComputerSystem (Switch).
OtherIdentifyingInfo		Mandatory	One element shall contain the DomainID stored in decimal format. Another value corresponding to 'SNIA:DetailedType' shall contain 'Virtual Switch'. Yet another element shall contain a Virtual Fabric ID corresponding to 'SNIA:VF_ID'. In addition, other 'SNIA:DetailedType' entries may also be in this property (e.g., 'Front Domain', 'Translate Domain' or 'Backbone').
Dedicated		Mandatory	See the Dedicated definition in section 4.7.10 CIM_ComputerSystem (Switch).

Table 11 - SMI Referenced Properties/Methods for CIM_ComputerSystem (Partitioned Switch)

Properties	Flags	Requirement	Description & Notes
IdentifyingDescriptions		Mandatory	One of the indices shall contain the value 'DomainID' and in the corresponding index for OtherIdentifyingInfo the value of the Domain ID. One of the other indices shall contain the value 'SNIA:DetailedType' and in the corresponding index for OtherIdentifyingInfo a value of 'Virtual Switch' for a Partitioned Switch. Yet another element shall contain 'SNIA:VF_ID' in the element that corresponds to the virtual fabric ID in OtherIdentifyingInfo.
EnabledState		Mandatory	Experimental. See the EnabledState definition in section 4.7.10 CIM_ComputerSystem (Switch).
RequestedState		Conditional	Conditional requirement: Required if the Switch profile is implemented. See the RequestedState definition in section 10.7.3 CIM_ComputerSystem (Switch) 10.7.3 CIM_ComputerSystem (Switch).
EnabledDefault		Optional	See the EnabledDefault definition in section 10.7.3 CIM_ComputerSystem (Switch)
RequestStateChange()		Conditional	Conditional requirement: Required if the Switch profile is implemented. See the RequestStateChange definition in section 10.7.3 CIM_ComputerSystem (Switch).

4.7.9 CIM_ComputerSystem (Storage Platform)

The ComputerSystem representing the Storage Platform (e.g. an Array). This class is typically instantiated if the end device has populated the Fibre Channel Platform Database.

Created By: Static

Modified By: Static

Deleted By: Static

Requirement: Mandatory

Table 12 describes class CIM_ComputerSystem (Storage Platform).

Table 12 - SMI Referenced Properties/Methods for CIM_ComputerSystem (Storage Platform)

Properties	Flags	Requirement	Description & Notes
CreationClassName		Mandatory	Name of Class.
Name	C	Mandatory	The Platform Name.
ElementName		Mandatory	The Platform Label.
NameFormat		Mandatory	
Dedicated		Mandatory	For a FC-GS Platform Type for storage subsystems, 'Storage' (3) or 'Unknown' (1).

4.7.10 CIM_ComputerSystem (Switch)

The ComputerSystem representing the Switch.

Created By: Static

Modified By: Static

Deleted By: Static

Requirement: Mandatory

Peer Zoning

Table 13 describes class CIM_ComputerSystem (Switch).

Table 13 - SMI Referenced Properties/Methods for CIM_ComputerSystem (Switch)

Properties	Flags	Requirement	Description & Notes
CreationClassName		Mandatory	Name of Class.
Name	C	Mandatory	The Switch WWN.
ElementName		Mandatory	The Switch Symbolic Name.
NameFormat		Mandatory	Shall be 'WWN'.
OperationalStatus		Mandatory	One of the defined values (2 3 6 8 9 10 11 12 13) shall be present in the array value.
OtherIdentifyingInfo		Mandatory	One element shall contain the DomainID stored in decimal format. Another value corresponding to 'SNIA:DetailedType' shall contain 'Front Domain', 'Translate Domain', 'Virtual Switch' or 'None'.
Dedicated		Mandatory	Shall be 5 (Switch).
IdentifyingDescriptions		Mandatory	One of the indices shall contain the value 'DomainID' and in the corresponding index for OtherIdentifyingInfo the value of the Domain ID. One of the other indices shall contain the value 'SNIA:DetailedType' and in the corresponding index for OtherIdentifyingInfo a value of 'Front Domain' for an Inter-Fabric Routing (IFR) Front Domain, 'Translate Domain' for an Inter-Fabric Routing (IFR) Translate Domain, 'Virtual Switch' for a Virtual Fabric Partitioned Switch, or 'None' when the other values don't apply.
EnabledState		Mandatory	Experimental. This property shall be 5 ('Not Applicable') when an implementation does not support the Switch Profile for this switch.
RequestedState		Conditional	Conditional requirement: Required if the Switch profile is implemented. See the RequestedState definition in section 10.7.3 CIM_ComputerSystem (Switch).
EnabledDefault		Optional	See the EnabledDefault definition in section 10.7.3 CIM_ComputerSystem (Switch).
RequestStateChange()		Conditional	Conditional requirement: Required if the Switch profile is implemented. See the RequestStateChange definition in section 10.7.3 CIM_ComputerSystem (Switch).

4.7.11 CIM_ConnectivityCollection

Collects the ProtocolEndpoints of the fabric.

Created By: Static

Modified By: Static

Deleted By: Static

Requirement: Mandatory

Table 14 describes class CIM_ConnectivityCollection.

Table 14 - SMI Referenced Properties/Methods for CIM_ConnectivityCollection

Properties	Flags	Requirement	Description & Notes
InstanceID		Mandatory	Opaque.
ElementName		Optional	Not required, can be the Fabric WWN.

4.7.12 CIM_ContainedDomain

Associates one or more Fabrics to a SAN.

Created By: Static
 Modified By: Static
 Deleted By: Static
 Requirement: Mandatory

Table 15 describes class CIM_ContainedDomain.

Table 15 - SMI Referenced Properties/Methods for CIM_ContainedDomain

Properties	Flags	Requirement	Description & Notes
PartComponent		Mandatory	The reference to the AdminDomain representing the Fabric (OtherIdentifyingInfo contains 'Fabric' with a corresponding 'SNIA:DetailedType' in IdentifyingDescriptions').
GroupComponent		Mandatory	The reference to the AdminDomain representing the SAN (OtherIdentifyingInfo contains 'SAN' with a corresponding 'SNIA:DetailedType' in IdentifyingDescriptions').

4.7.13 CIM_DeviceSAPImplementation (Non-Switch to FCPort)

Associates the Non-Switch (Host or Storage) FCPort to the ProtocolEndpoint.

Created By: Static
 Modified By: Static
 Deleted By: Static
 Requirement: Mandatory

Table 16 describes class CIM_DeviceSAPImplementation (Non-Switch to FCPort).

Table 16 - SMI Referenced Properties/Methods for CIM_DeviceSAPImplementation (Non-Switch to FCPort)

Properties	Flags	Requirement	Description & Notes
Dependent		Mandatory	Reference to the ProtocolEndpoint.
Antecedent		Mandatory	Reference to the Non-Switch FCPort (Host or Storage).

4.7.14 CIM_DeviceSAPImplementation (Switch to FCPort)

Associates the Switch FCPort to the ProtocolEndpoint.

Created By: Static
 Modified By: Static
 Deleted By: Static
 Requirement: Mandatory

Peer Zoning

Table 17 describes class CIM_DeviceSAPImplementation (Switch to FCPort).

Table 17 - SMI Referenced Properties/Methods for CIM_DeviceSAPImplementation (Switch to FCPort)

Properties	Flags	Requirement	Description & Notes
Dependent		Mandatory	Reference to the ProtocolEndpoint.
Antecedent		Mandatory	Reference to the Switch FCPort or Virtual Switch FCPort.

4.7.15 CIM_ElementCapabilities (ZoneCapabilities to Fabric.)

Associates the ZoneCapabilities to a System. The system is the AdminDomain representing the Fabric.

Created By: Static

Modified By: Static

Deleted By: Static

Requirement: Mandatory

Table 18 describes class CIM_ElementCapabilities (ZoneCapabilities to Fabric.).

Table 18 - SMI Referenced Properties/Methods for CIM_ElementCapabilities (ZoneCapabilities to Fabric.)

Properties	Flags	Requirement	Description & Notes
Capabilities		Mandatory	Reference to ZoneCapabilities.
ManagedElement		Mandatory	Reference to a Fabric AdminDomain (OtherIdentifyingInfo contains 'Fabric' with a corresponding 'SNIA:DetailedType' in IdentifyingDescriptions).

4.7.16 CIM_ElementCapabilities (ZoneCapabilities to Switch.)

Associates the ZoneCapabilities to a System. The system normally is the AdminDomain representing the Fabric, but in some cases where the Zone Database is not a fabric entity, it maybe hosted on a ComputerSystem representing the Switch.

Created By: Static

Modified By: Static

Deleted By: Static

Requirement: Mandatory

Table 19 describes class CIM_ElementCapabilities (ZoneCapabilities to Switch.).

Table 19 - SMI Referenced Properties/Methods for CIM_ElementCapabilities (ZoneCapabilities to Switch.)

Properties	Flags	Requirement	Description & Notes
Capabilities		Mandatory	Reference to ZoneCapabilities.
ManagedElement		Mandatory	Reference to a Switch ComputerSystem.

4.7.17 CIM_ElementSettingData (ZoneMembershipSettingData to Zone)

Associates ZoneMembershipSettingData to the Zone.

Created By: Extrinsic: AddZoneMemberSettingData

Peer Zoning

Modified By: Static
 Deleted By: Static
 Requirement: Mandatory

Table 20 describes class CIM_ElementSettingData (ZoneMembershipSettingData to Zone).

Table 20 - SMI Referenced Properties/Methods for CIM_ElementSettingData (ZoneMembershipSettingData to Zone)

Properties	Flags	Requirement	Description & Notes
SettingData		Mandatory	Reference to a ZoneMembershipSettingData.
ManagedElement		Mandatory	Reference to the Zone.

4.7.18 CIM_FCActiveConnection

Experimental. The association between ProtocolEndpoints representing the links between fibre channel devices (including ISLs). For loops and NPIV, multiple ActiveConnections are instantiated as one to many relationships.

Created By: Static
 Modified By: Static
 Deleted By: Static
 Requirement: Optional

Table 21 describes class CIM_FCActiveConnection.

Table 21 - SMI Referenced Properties/Methods for CIM_FCActiveConnection

Properties	Flags	Requirement	Description & Notes
Discriminator		Optional	An array property enumeration used to discriminate the context in which the ActiveConnection is instantiated. Values supported by this standard include '0' (Unknown), '2' (None), '3' (NPIV), '4' (Chassis), '5' (Virtual Fabric) or '6' (IFR), or '10' (FCoE).
Antecedent		Mandatory	The reference to the ProtocolEndpoint for one end of the link.
Dependent		Mandatory	The reference to the ProtocolEndpoint for the other end of the link.

4.7.19 CIM_FCPort (Host FCPort)

Fibre Channel Port for Host Platforms.

Created By: Static
 Modified By: Static
 Deleted By: Static
 Requirement: Mandatory

Peer Zoning

Table 22 describes class CIM_FCPort (Host FCPort).

Table 22 - SMI Referenced Properties/Methods for CIM_FCPort (Host FCPort)

Properties	Flags	Requirement	Description & Notes
SystemCreationClassName		Mandatory	The scoping System's CreationClassName.
SystemName		Mandatory	The scoping System's Name.
CreationClassName		Mandatory	Name of Class.
DeviceID		Mandatory	Opaque.
ElementName		Optional	Port Symbolic Name if available. Otherwise NULL. If the underlying implementation includes characters that are illegal in CIM strings, then truncate before the first of those characters.
PermanentAddress	CD	Mandatory	Fibre Channel Port WWN. Expressed as 16 un-separated upper case hex digits.
NetworkAddresses	C	Mandatory	Fibre Channel ID (FCID). Expressed as 8 un-separated upper case hex digits.
OperationalStatus		Mandatory	One of the defined values (0 2 6 10 11) shall be present in the array value.
PortType		Mandatory	The specific port type (0 1 10 11 12 13 14 15 16 17 18) currently enabled (from FC-GS Port.Type).
LinkTechnology		Mandatory	Shall be 4 ('FC').
SupportedFC4Types		Optional	An array of integers indicating the Fibre Channel FC-4 protocols supported. EXPERIMENTAL When supporting FC-SB, this property shall be either '27' (FC-SB-2 Channel) for Host Ports or '28' (FC-SB-2 Control Unit) for targets. EXPERIMENTAL.
SupportedCOS		Optional	An array of integers indicating the Fibre Channel Classes of Service that are supported. EXPERIMENTAL When supporting FC-SB, this property shall be either '2' or '3' for FC-SB-2 Channel or FC-SB-2 Control Unit ports, respectively. EXPERIMENTAL.

4.7.20 CIM_FCPort (Host NPIV FCPort)

Experimental. A Host NPIV Fibre Channel Port for Host Platforms.

Created By: Static

Modified By: Static

Deleted By: Static

Requirement: Optional

Table 23 describes class CIM_FCPort (Host NPIV FCPort).

Table 23 - SMI Referenced Properties/Methods for CIM_FCPort (Host NPIV FCPort)

Properties	Flags	Requirement	Description & Notes
SystemCreationClassName		Mandatory	The scoping System's CreationClassName.
SystemName		Mandatory	The scoping System's Name.
CreationClassName		Mandatory	Name of Class.
DeviceID		Mandatory	Opaque.
ElementName		Optional	Port Symbolic Name if available. Otherwise NULL. If the underlying implementation includes characters that are illegal in CIM strings, then truncate before the first of those characters.
PermanentAddress	CD	Mandatory	Fibre Channel Port WWN. Expressed as 16 un-separated upper case hex digits.
NetworkAddresses	C	Mandatory	Fibre Channel ID (FCID). Expressed as 8 un-separated upper case hex digits.
OperationalStatus		Mandatory	One of the defined values (0 2 6 10 11) shall be present in the array value.
PortType		Mandatory	The specific port type (0 1 10 11 12 13 14 15 16 17 18) currently enabled (from FC-GS Port.Type).
LinkTechnology		Mandatory	Shall be 4 ('FC').
PortDiscriminator		Mandatory	Experimental. For NPIV Host FCPorts this shall contain '7' (NPIV).
SupportedFC4Types		Optional	An array of integers indicating the Fibre Channel FC-4 protocols supported. EXPERIMENTAL [When supporting FC-SB, this property shall be either '27' (FC-SB-2 Channel) for Host Ports or '28' (FC-SB-2 Control Unit) for targets.] EXPERIMENTAL .
SupportedCOS		Optional	An array of integers indicating the Fibre Channel Classes of Service that are supported. EXPERIMENTAL [When supporting FC-SB, this property shall be either '2' or '3' for FC-SB-2 Channel or FC-SB-2 Control Unit ports, respectively.] EXPERIMENTAL .

4.7.21 CIM_FCPort (Partitioned Switch FCPort)

Fibre Channel Port for Partitioned Switch.

Created By: Static

Modified By: Static

Deleted By: Static

Requirement: Support for the Switch Partitioning profile.

Peer Zoning

Table 24 describes class CIM_FCPort (Partitioned Switch FCPort).

Table 24 - SMI Referenced Properties/Methods for CIM_FCPort (Partitioned Switch FCPort)

Properties	Flags	Requirement	Description & Notes
SystemCreationClassName		Mandatory	See the SystemCreationClassName definition in section <i>Storage Management Technical Specification, Part 6 Fabric, 1.8.0 Rev 4 4.7.23</i> CIM_FCPort (Switch FCPort).
SystemName		Mandatory	See the SystemName definition in section <i>Storage Management Technical Specification, Part 6 Fabric, 1.8.0 Rev 4 4.7.23</i> CIM_FCPort (Switch FCPort).
CreationClassName		Mandatory	See the CreationClassName definition in section 4.7.23 CIM_FCPort (Switch FCPort).
DeviceID		Mandatory	See the DeviceID definition in section 4.7.23 CIM_FCPort (Switch FCPort).
ElementName		Mandatory	See the ElementName definition in section 4.7.23 CIM_FCPort (Switch FCPort).
PermanentAddress	CD	Mandatory	See the PermanentAddress definition in section 4.7.23 CIM_FCPort (Switch FCPort).
Speed		Conditional	Conditional requirement: Required if the Switch profile is implemented. See the Speed definition in section 10.7.12 CIM_FCPort (Switch FCPort).
OperationalStatus		Mandatory	See the OperationalStatus definition in section 4.7.23 CIM_FCPort (Switch FCPort).
PortType		Mandatory	See the PortType definition in section 4.7.23 CIM_FCPort (Switch FCPort).
LinkTechnology		Mandatory	See the LinkTechnology definition in section 4.7.23 CIM_FCPort (Switch FCPort).
EnabledState		Mandatory	Experimental. See the EnabledState definition in section 4.7.23 CIM_FCPort (Switch FCPort).
DetailedPortState		Conditional	Experimental. Conditional requirement: Required if the Switch profile is implemented. See Table 94 - DetailedPortState for FCPort.
PortAvailability		Optional	Experimental. See <i>Storage Management Technical Specification, Part 6 Fabric, 1.8.0 Rev 4</i> Table 95 - PortAvailability for FCPort.
RequestedState		Conditional	Conditional requirement: Required if the Switch profile is implemented. See the RequestedState definition in section 10.7.12 CIM_FCPort (Switch FCPort).
EnabledDefault		Conditional	Conditional requirement: Required if the Switch profile is implemented. See the EnabledDefault definition in section 10.7.12 CIM_FCPort (Switch FCPort).
MaxSpeed		Conditional	Conditional requirement: Required if the Switch profile is implemented. See the MaxSpeed definition in section 10.7.12 CIM_FCPort (Switch FCPort).
PortNumber		Conditional	Conditional requirement: Required if the Switch profile is implemented. See the PortNumber definition in section 10.7.12 CIM_FCPort (Switch FCPort).

Peer Zoning

Table 24 - SMI Referenced Properties/Methods for CIM_FCPort (Partitioned Switch FCPort)

Properties	Flags	Requirement	Description & Notes
PortDiscriminator		Mandatory	Experimental. This array property identifies the context in which this FCPort is instantiated. For a Partitioned Switch FCPort, the values may be '3' (VF), '6' (IFR (Virtual)) or '7' (NPV).
RequestStateChange()		Conditional	Conditional requirement: Support for the Switch Profile and a non-null value in FCPortCapabilities.RequestedStatesSupported. See the RequestStateChange definition in section 10.7.12 CIM_FCPort (Switch FCPort).

4.7.22 CIM_FCPort (Storage FCPort)

Fibre Channel Port for Storage Platforms.

Created By: Static

Modified By: Static

Deleted By: Static

Requirement: Mandatory

Table 25 describes class CIM_FCPort (Storage FCPort).

Table 25 - SMI Referenced Properties/Methods for CIM_FCPort (Storage FCPort)

Properties	Flags	Requirement	Description & Notes
SystemCreationClassName		Mandatory	The scoping System's CreationClassName.
SystemName		Mandatory	The scoping System's Name.
CreationClassName		Mandatory	Name of Class.
DeviceID		Mandatory	Opaque.
ElementName		Optional	Port Symbolic Name if available. Otherwise NULL. If the underlying implementation includes characters that are illegal in CIM strings, then truncate before the first of those characters.
PermanentAddress	CD	Mandatory	Fibre Channel Port WWN. Expressed as 16 un-separated upper case hex digits.
NetworkAddresses	C	Mandatory	Fibre Channel ID (FCID). Expressed as 8 un-separated upper case hex digits.
OperationalStatus		Mandatory	One of the defined values (0 2 6 10 11) shall be present in the array value.
PortType		Mandatory	The specific port type (0 1 10 11 12 13 14 15 16 17 18) currently enabled (from FC-GS Port.Type).
LinkTechnology		Mandatory	Shall be 4 ('FC').
SupportedFC4Types		Optional	An array of integers indicating the Fibre Channel FC-4 protocols supported. EXPERIMENTAL When supporting FC-SB, this property shall be either '27' (FC-SB-2 Channel) for Host Ports or '28' (FC-SB-2 Control Unit) for targets. EXPERIMENTAL .
SupportedCOS		Optional	An array of integers indicating the Fibre Channel Classes of Service that are supported. EXPERIMENTAL When supporting FC-SB, this property shall be either '2' or '3' for FC-SB-2 Channel or FC-SB-2 Control Unit ports, respectively. EXPERIMENTAL .

Peer Zoning

4.7.23 CIM_FCPort (Switch FCPort)

Fibre Channel Port for Switch.

Created By: Static

Modified By: Static

Deleted By: Static

Requirement: Mandatory

Table 26 describes class CIM_FCPort (Switch FCPort).

Table 26 - SMI Referenced Properties/Methods for CIM_FCPort (Switch FCPort)

Properties	Flags	Requirement	Description & Notes
SystemCreationClassName		Mandatory	The scoping System's CreationClassName.
SystemName		Mandatory	The scoping System's Name.
CreationClassName		Mandatory	Name of Class.
DeviceID		Mandatory	Opaque.
ElementName		Mandatory	Port Symbolic Name if available. Otherwise NULL. If the underlying implementation includes characters that are illegal in CIM strings, then truncate before the first of those characters.
PermanentAddress	CD	Mandatory	Fibre Channel Port WWN.
Speed		Conditional	Conditional requirement: Required if the Switch profile is implemented. See the Speed definition in section 10.7.12 CIM_FCPort (Switch FCPort).
OperationalStatus		Mandatory	One of the defined values (0 2 6 10 11) shall be present in the array value.
PortType		Mandatory	The specific port type (0 1 10 11 12 13 14 15 16 17 18) currently enabled (from FC-GS Port.Type).
LinkTechnology		Mandatory	This shall be 4 ('FC').
EnabledState		Mandatory	Experimental. This property shall be 5 ('Not Applicable') when an implementation does not support the Switch Profile for the switch this port is on.
DetailedPortState		Conditional	Experimental. Conditional requirement: Required if the Switch profile is implemented. See Table 94 - DetailedPortState for FCPort.
PortAvailability		Optional	Experimental. See Table 95 - PortAvailability for FCPort.
RequestedState		Conditional	Conditional requirement: Required if the Switch profile is implemented. See the RequestedState definition in section 10.7.12 CIM_FCPort (Switch FCPort).
EnabledDefault		Conditional	Conditional requirement: Required if the Switch profile is implemented. See the EnabledDefault definition in section 10.7.12 CIM_FCPort (Switch FCPort).
MaxSpeed		Conditional	Conditional requirement: Required if the Switch profile is implemented. See the MaxSpeed definition in section 10.7.12 CIM_FCPort (Switch FCPort).
PortNumber		Conditional	Conditional requirement: Required if the Switch profile is implemented. See the PortNumber definition in section 10.7.12 CIM_FCPort (Switch FCPort).

Peer Zoning

Table 26 - SMI Referenced Properties/Methods for CIM_FCPort (Switch FCPort)

Properties	Flags	Requirement	Description & Notes
PortDiscriminator		Optional	Experimental. This array property identifies the context in which this FCPort is instantiated. For this version of the standard, the values may be '0' (Unknown), '2' (Not applicable), '3' (VF), '4' (FCIP), '5' (IFR), '6' (IFR (Virtual)), '7' (NPIV), '8' (Internal) or '9' (Chassis).
RequestStateChange()		Conditional	Conditional requirement: Support for the Switch Profile and a non-null value in FCPortCapabilities.RequestedStatesSupported. See the RequestStateChange definition in section 10.7.12 CIM_FCPort (Switch FCPort).

4.7.24 CIM_HostedAccessPoint (AdminDomain to ProtocolEndpoint)

Associates the ProtocolEndpoint to the Fabric AdminDomain for those systems not registered in the Platform Database or discovered through FDMI.

- Created By: Static
- Modified By: Static
- Deleted By: Static
- Requirement: Optional

Table 27 describes class CIM_HostedAccessPoint (AdminDomain to ProtocolEndpoint).

Table 27 - SMI Referenced Properties/Methods for CIM_HostedAccessPoint (AdminDomain to ProtocolEndpoint)

Properties	Flags	Requirement	Description & Notes
Dependent		Mandatory	Reference to the ProtocolEndpoint.
Antecedent		Mandatory	Reference to the Fabric AdminDomain (OtherIdentifyingInfo contains 'Fabric' with a corresponding 'SNIA:DetailedType' in IdentifyingDescriptions).

4.7.25 CIM_HostedAccessPoint (ComputerSystem to ProtocolEndpoint)

Associates the ProtocolEndpoint to the hosting System. The hosting System is a ComputerSystem for the Switch or Platform.

- Created By: Static
- Modified By: Static
- Deleted By: Static
- Requirement: Mandatory

Peer Zoning

Table 28 describes class CIM_HostedAccessPoint (ComputerSystem to ProtocolEndpoint).

Table 28 - SMI Referenced Properties/Methods for CIM_HostedAccessPoint (ComputerSystem to ProtocolEndpoint)

Properties	Flags	Requirement	Description & Notes
Dependent		Mandatory	Reference to the ProtocolEndpoint.
Antecedent		Mandatory	Reference to the Switch, Storage Platform or Host Platform ComputerSystem.

4.7.26 CIM_HostedCollection (Fabric to ConnectivityCollection)

Associates the ConnectivityCollection to the AdminDomain representing the Fabric.

Created By: Static

Modified By: Static

Deleted By: Static

Requirement: Mandatory

Table 29 describes class CIM_HostedCollection (Fabric to ConnectivityCollection).

Table 29 - SMI Referenced Properties/Methods for CIM_HostedCollection (Fabric to ConnectivityCollection)

Properties	Flags	Requirement	Description & Notes
Dependent		Mandatory	Reference to the ConnectivityCollection.
Antecedent		Mandatory	Reference to the Fabric AdminDomain (OtherIdentifyingInfo contains 'Fabric' with a corresponding 'SNIA:DetailedType' in IdentifyingDescriptions).

4.7.27 CIM_HostedCollection (System to LogicalPortGroup)

Associates the LogicalPortGroup to the ComputerSystem representing the platform (host or array) or the Fabric (if platforms are not implemented).

Created By: Static

Modified By: Static

Deleted By: Static

Requirement: Mandatory

Table 30 describes class CIM_HostedCollection (System to LogicalPortGroup).

Table 30 - SMI Referenced Properties/Methods for CIM_HostedCollection (System to LogicalPortGroup)

Properties	Flags	Requirement	Description & Notes
Dependent		Mandatory	Reference to the LogicalPortGroup.
Antecedent		Mandatory	Reference to the Platform ComputerSystem or Fabric AdminDomain.

4.7.28 CIM_HostedCollection (Zones or ZoneSets to Fabric)

Associates the ZoneSets and Zones to the AdminDomain representing the Fabric.

Peer Zoning

Created By: Static
 Modified By: Static
 Deleted By: Static
 Requirement: Mandatory

Table 31 describes class CIM_HostedCollection (Zones or ZoneSets to Fabric).

Table 31 - SMI Referenced Properties/Methods for CIM_HostedCollection (Zones or ZoneSets to Fabric)

Properties	Flags	Requirement	Description & Notes
Dependent		Mandatory	Reference to the Zone or ZoneSet.
Antecedent		Mandatory	Reference to the Fabric AdminDomain (OtherIdentifyingInfo contains 'Fabric' with a corresponding 'SNIA:DetailedType' in IdentifyingDescriptions').

4.7.29 CIM_HostedCollection (Zones or ZoneSets to Switch)

Associates the ZoneSets and Zones to the hosting System (the ComputerSystem representing the switch).

Created By: Static
 Modified By: Static
 Deleted By: Static
 Requirement: Mandatory

Table 32 describes class CIM_HostedCollection (Zones or ZoneSets to Switch).

Table 32 - SMI Referenced Properties/Methods for CIM_HostedCollection (Zones or ZoneSets to Switch)

Properties	Flags	Requirement	Description & Notes
Dependent		Mandatory	Reference to the Zone or ZoneSet.
Antecedent		Mandatory	Reference to the Switch ComputerSystem.

4.7.30 CIM_HostedDependency

Experimental. The association representing the relationship of the FCPort that hosts the FCPorts that are virtualized. This association is required for all FCPorts that are instantiated as part of NPIV.

Created By: Static
 Modified By: Static
 Deleted By: Static
 Requirement: Optional

Peer Zoning

Table 33 describes class CIM_HostedDependency.

Table 33 - SMI Referenced Properties/Methods for CIM_HostedDependency

Properties	Flags	Requirement	Description & Notes
Antecedent		Mandatory	A reference to the hosting Host FCPort ("physical? fibre channel port).
Dependent		Mandatory	A reference to the hosted Host NPIV FCPort (virtualized fibre channel port with PortDiscriminator='7').

4.7.31 CIM_LogicalPortGroup

Represents the Fibre Channel Node. Associated to the host system by the HostedCollection Association. The hosting System is either a ComputerSystem representing the Platform or the AdminDomain representing the fabric in the case for those systems not registered in the Platform Database or discovered through FDMI (but available through the Name Server/Management Server).

Created By: Static

Modified By: Static

Deleted By: Static

Requirement: Mandatory

Table 34 describes class CIM_LogicalPortGroup.

Table 34 - SMI Referenced Properties/Methods for CIM_LogicalPortGroup

Properties	Flags	Requirement	Description & Notes
InstanceID		Mandatory	Opaque.
Name	CD	Mandatory	Fibre Channel Node WWN.
NameFormat		Mandatory	Shall be 'WWN'.
ElementName	N	Mandatory	Node Symbolic Name if available. Otherwise NULL. If the underlying implementation includes characters that are illegal in CIM strings, then truncate before the first of those characters.

4.7.32 CIM_MemberOfCollection (ConnectivityCollection to ProtocolEndpoint)

Created By: Static

Modified By: Static

Deleted By: Static

Requirement: Mandatory

Table 35 describes class CIM_MemberOfCollection (ConnectivityCollection to ProtocolEndpoint).

Table 35 - SMI Referenced Properties/Methods for CIM_MemberOfCollection (ConnectivityCollection to ProtocolEndpoint)

Properties	Flags	Requirement	Description & Notes
Collection		Mandatory	Reference to the ConnectivityCollection.
Member		Mandatory	Reference to the ProtocolEndpoint.

4.7.33 CIM_MemberOfCollection (LogicalPortGroup to FCPort)

Created By: Static
 Modified By: Static
 Deleted By: Static
 Requirement: Mandatory

Table 36 describes class CIM_MemberOfCollection (LogicalPortGroup to FCPort).

Table 36 - SMI Referenced Properties/Methods for CIM_MemberOfCollection (LogicalPortGroup to FCPort)

Properties	Flags	Requirement	Description & Notes
Collection		Mandatory	Reference to the LogicalPortGroup.
Member		Mandatory	Reference to the Non-Switch (Host or Storage) FCPort.

4.7.34 CIM_MemberOfCollection (ZoneSet to Zone)

Created By: Static
 Modified By: Static
 Deleted By: Static
 Requirement: Mandatory

Table 37 describes class CIM_MemberOfCollection (ZoneSet to Zone).

Table 37 - SMI Referenced Properties/Methods for CIM_MemberOfCollection (ZoneSet to Zone)

Properties	Flags	Requirement	Description & Notes
Collection		Mandatory	Reference to the ZoneSet.
Member		Mandatory	Reference to the Zone.

4.7.35 CIM_ProtocolEndpoint

The endpoint of a link (ActiveConnection). ProtocolEndpoint shall be implemented when an ActiveConnection exists. It may be implemented if no ActiveConnections exist.

Created By: Static
 Modified By: Static
 Deleted By: Static
 Requirement: Mandatory

Table 38 describes class CIM_ProtocolEndpoint.

Table 38 - SMI Referenced Properties/Methods for CIM_ProtocolEndpoint

Properties	Flags	Requirement	Description & Notes
SystemCreationClassName		Mandatory	The scoping System's CreationClassName.
SystemName		Mandatory	The scoping System's Name.
CreationClassName		Mandatory	Name of Class.
Name	CD	Mandatory	The Fibre Channel Port WWN.

Peer Zoning

Table 38 - SMI Referenced Properties/Methods for CIM_ProtocolEndpoint

Properties	Flags	Requirement	Description & Notes
NameFormat		Mandatory	'WWN'.
ProtocollFType		Mandatory	Shall be 56(Fibre channel).

4.7.36 CIM_SystemDevice (Non-Switch FCPort to Fabric)

Associates non-Switch FCPorts to the System (Fabric).

Created By: Static

Modified By: Static

Deleted By: Static

Requirement: Optional

Table 39 describes class CIM_SystemDevice (Non-Switch FCPort to Fabric).

Table 39 - SMI Referenced Properties/Methods for CIM_SystemDevice (Non-Switch FCPort to Fabric)

Properties	Flags	Requirement	Description & Notes
PartComponent		Mandatory	The reference to a Host or Storage FCPort.
GroupComponent		Mandatory	The reference to the Fabric (OtherIdentifyingInfo contains 'Fabric' with a corresponding 'SNIA:DetailedType' in IdentifyingDescriptions).

4.7.37 CIM_SystemDevice (Non-Switch FCPort to Platform)

Associates non-switch FCPorts to the Platform ComputerSystem.

Created By: Static

Modified By: Static

Deleted By: Static

Requirement: Optional

Table 40 describes class CIM_SystemDevice (Non-Switch FCPort to Platform).

Table 40 - SMI Referenced Properties/Methods for CIM_SystemDevice (Non-Switch FCPort to Platform)

Properties	Flags	Requirement	Description & Notes
PartComponent		Mandatory	The reference to a Host or Storage FcPort.
GroupComponent		Mandatory	The reference to the Platform (Storage or Host) System.

4.7.38 CIM_SystemDevice (Switch FCPort to Switch)

Associates the Switch FCPort to the ComputerSystem (Switch).

Created By: Static

Modified By: Static

Deleted By: Static

Requirement: Mandatory

Peer Zoning

Table 41 describes class CIM_SystemDevice (Switch FCPort to Switch).

Table 41 - SMI Referenced Properties/Methods for CIM_SystemDevice (Switch FCPort to Switch)

Properties	Flags	Requirement	Description & Notes
PartComponent		Mandatory	The reference to the switch FCPort.
GroupComponent		Mandatory	The reference to the Switch ComputerSystem.

4.7.39 CIM_Zone (Active)

The active Zones being enforced by the Fabric.

Created By: Extrinsic: ActivateZoneSet

Modified By: Static

Deleted By: Static

Requirement: Mandatory

Table 42 describes class CIM_Zone (Active).

Table 42 - SMI Referenced Properties/Methods for CIM_Zone (Active)

Properties	Flags	Requirement	Description & Notes
InstanceID		Mandatory	Opaque.
ElementName		Mandatory	The Zone Name.
ZoneType		Mandatory	The Zone Type.
Active		Mandatory	Shall be TRUE. Indicates that this ZoneSet is active.

4.7.40 CIM_Zone (Inactive)

The inactive Zones being enforced by the Fabric.

Created By: Extrinsic: CreateZone

Modified By: Static

Deleted By: Static

Requirement: Mandatory

Table 43 describes class CIM_Zone (Inactive).

Table 43 - SMI Referenced Properties/Methods for CIM_Zone (Inactive)

Properties	Flags	Requirement	Description & Notes
InstanceID		Mandatory	Opaque.
ElementName		Mandatory	The Zone Name.
ZoneType		Mandatory	The Zone Type.
Active		Mandatory	Shall be FALSE. Indicates that this ZoneSet is inactive.

4.7.41 CIM_ZoneCapabilities

The Zoning Capabilities of the associated Fabric (or Switch).

Peer Zoning

ZoneCapabilities exposes the capabilities of the AdminDomain representing the Fabric for active zoning and the capabilities of the ComputerSystem representing the Switch or AdminDomain representing the Fabric for Zone Set Database.

If a ZoneCapability property is not applicable or does not explicitly exists (e.g. the capability is limited only by a memory size), the property is NULL.

Created By: Static

Modified By: Static

Deleted By: Static

Requirement: Mandatory

Table 44 describes class CIM_ZoneCapabilities.

Table 44 - SMI Referenced Properties/Methods for CIM_ZoneCapabilities

Properties	Flags	Requirement	Description & Notes
InstanceID		Mandatory	Opaque.
MaxNumZoneSets		Optional	The maximum number of ZoneSets in the Zone Set Database. NULL should be returned in such cases when the property is not applicable or the number is not limited explicitly.
MaxNumZone		Optional	The maximum number of Zones in the Zone Set Database. NULL should be returned in such cases when the property is not applicable or the number is not limited explicitly.
MaxNumZoneMembers		Optional	The maximum number of ZoneMembers in the Zone Set Database. All ZoneMembers included in both Zones and ZoneAliases are counted, while the same ZoneMember included in multiple Zones or ZoneAliases is counted only once. NULL should be returned in such cases when the property is not applicable or the number is not limited explicitly.
MaxNumZoneAliases		Optional	The maximum number of ZoneAliases in the Zone Set Database NULL should be returned in such cases when the property is not applicable or the number is not limited explicitly.
ZoneNameMaxLen		Mandatory	The maximum length for the name of a ZoneAlias (NamedAddressCollection.ElementName), Zone (Zone.ElementName) or ZoneSet (ZoneSet.ElementName) the Fabric (or Switch) are capable of supporting.
ZoneNameFormat		Mandatory	The name format of a ZoneAlias *NamedAddressCollection.ElementName), Zone (Zone.ElementName) or ZoneSet (ZoneSet.ElementName) supported by either the Fabric (or the Switch).
MaxNumZonesPerZoneSet		Optional	The maximum number of Zones per ZoneSet. NULL should be returned in such cases when the property is not applicable or the number is not limited explicitly.
SupportedConnectivityMemberTypes		Mandatory	An array containing the supported connectivity member types supported which include Permanent Address (WWN), Switch Port ID (Domain:Port in base 10), Network Address (FCID), Logical Port Group (Node WWN).
PeerZoningSupported		Optional	Experimental. Specifies whether any peer zoning is supported and which types of peer zoning is supported.

4.7.42 CIM_ZoneMembershipSettingData

Defines the zone member.

Created By: Extrinsic: AddZoneMemberSettingData

Modified By: Static

Deleted By: Static

Requirement: Mandatory

Table 45 describes class CIM_ZoneMembershipSettingData.

Table 45 - SMI Referenced Properties/Methods for CIM_ZoneMembershipSettingData

Properties	Flags	Requirement	Description & Notes
InstanceID		Mandatory	Opaque.
ConnectivityMemberType		Mandatory	Permanent Address (WWN), Switch Port ID (Domain:Port in base10), Network Address (FCID).
ConnectivityMemberID	C	Mandatory	The value of the WWN, Domain/Port, or FCID.

4.7.43 CIM_ZoneSet (Active)

The active ZoneSet being enforced by the Fabric.

Created By: Extrinsic: ActivateZoneSet

Modified By: Static

Deleted By: Static

Requirement: Mandatory

Table 46 describes class CIM_ZoneSet (Active).

Table 46 - SMI Referenced Properties/Methods for CIM_ZoneSet (Active)

Properties	Flags	Requirement	Description & Notes
InstanceID		Mandatory	Opaque.
ElementName		Mandatory	The ZoneSet name.
Active		Mandatory	shall be TRUE. Indicates that this ZoneSet is active and members cannot be changed.

4.7.44 CIM_ZoneSet (Inactive)

The inactive ZoneSets.

Created By: Extrinsic: CreateZoneSet

Modified By: Static

Deleted By: Static

Requirement: Mandatory

Peer Zoning

Table 47 describes class CIM_ZoneSet (Inactive).

Table 47 - SMI Referenced Properties/Methods for CIM_ZoneSet (Inactive)

Properties	Flags	Requirement	Description & Notes
InstanceID		Mandatory	Opaque.
ElementName		Mandatory	The ZoneSet name.
Active		Mandatory	Shall be FALSE. Indicates that this ZoneSet is inactive.

STABLE

EXPERIMENTAL

4.7.45 CIM_ZoneSettingData (ZoneMembershipSettingData to Zone)

Associates ZoneMembershipSettingData to the Zone.

Created By: Extrinsic: AddZoneMemberSettingDataWithRole

Modified By: Static

Deleted By: Static

Requirement: Required if the CIM_ZoneCapabilities.PeerZoningSupported='4' (Peer User) or '5' (Peer Target).

Figure 48 describes class CIM_ZoneSettingData (ZoneMembershipSettingData to Zone)

Table 48 - SMI Referenced Properties/Methods for CIM_ZoneSettingData (ZoneMembershipSettingData to Zone)

Properties	Flags	Requirement	Description & Notes
SettingData		Mandatory	Reference to a ZoneMembershipSettingData.
ManagedElement		Mandatory	Reference to Zone.
ZoneMembershipRole		Mandatory	Specifies whether peer zoning is supported and which types of peer zoning is supported..

EXPERIMENTAL

STABLE
5 Enhanced Zoning and Enhanced Zone Control Profile**5.1 Synopsis****Profile Name:** Enhanced Zoning and Enhanced Zoning Control (Component Profile)**Version:** 1.4.0**Organization:** SNIA**Central Class:** ZoneService**Scoping Class:** an AdminDomain in a referencing autonomous profile**Related Profiles:** Table 49 describes the supported profiles for Enhanced Zoning and Enhanced Zoning Control.**Table 49 - Supported Profiles for Enhanced Zoning and Enhanced Zoning Control**

Profile Name	Organization	Version	Requirement	Description
Zone Control	SNIA	1.8.0	Mandatory	

5.2 Description

This profile describes the additional zoning functions for enhanced zoning. Note that Sessions are normally part of enhanced zoning, but are included in the base fabric profile to address the various types of zoning operations into a single object model. In this profile, then only Zone Alias is added.

5.3 Health and Fault Management

Not defined in this document

5.4 Cascading Considerations

Not defined in this document

5.5 Methods of this Profile**5.5.1 CreateZoneAlias**

The method creates a ZoneAlias and the association HostedCollection. The newly created association, HostedCollection, associates the ZoneAlias to the same AdminDomain the ZoneService is hosted to. For the newly created ZoneAlias, the Active property is always set to false.

```
CreateZoneAlias(
    [IN] string CollectionAlias,
    [OUT] CIM_NamedAddressCollection ref ZoneAlias);
```

5.5.2 AddZoneAlias

Adds to the Zone the specified ZoneAlias.

```
AddZoneAlias(
    [IN] CIM_Zone ref Zone,
    [IN] CIM_NamedAddressCollection ref ZoneAlias);
```

5.6 Use Cases

Not defined in this document.

5.7 CIM Elements

5.7.1 Overview

Table 50 describes the CIM elements for Enhanced Zoning and Enhanced Zoning Control.

Table 50 - CIM Elements for Enhanced Zoning and Enhanced Zoning Control

Element Name	Requirement	Description
5.7.2 CIM_ElementSettingData (ZoneMembershipSettingData to NamedAddressCollection)	Mandatory	Associates ZoneMembershipSettingData to the NamedAddressCollection representing the ZoneAlias.
5.7.3 CIM_HostedCollection (AdminDomain to Collection)	Mandatory	Associates the NameAddressCollection representing the Zone Alias to the AdminDomain.
5.7.4 CIM_HostedCollection (ComputerSystem to Collection)	Mandatory	Associates the NameAddressCollection representing the Zone Alias to the System.
5.7.5 CIM_MemberOfCollection	Mandatory	Associates NamedAddressCollection with Zone.
5.7.6 CIM_NamedAddressCollection	Mandatory	The Zone Alias.
5.7.7 CIM_ZoneService (Zone Service)	Mandatory	The service that allows for all of the zoning configuration changes.

5.7.2 CIM_ElementSettingData (ZoneMembershipSettingData to NamedAddressCollection)

Associates ZoneMembershipSettingData to the NamedAddressCollection representing the ZoneAlias.

Created By: Static

Modified By: Static

Deleted By: Static

Requirement: Mandatory

Table 51 describes class CIM_ElementSettingData (ZoneMembershipSettingData to NamedAddressCollection).

Table 51 - SMI Referenced Properties/Methods for CIM_ElementSettingData (ZoneMembershipSettingData to NamedAddressCollection)

Properties	Flags	Requirement	Description & Notes
SettingData		Mandatory	
ManagedElement		Mandatory	

5.7.3 CIM_HostedCollection (AdminDomain to Collection)

Associates the NamedAddressCollection representing the Zone Alias to the AdminDomain representing the Fabric.

Created By: Static

Modified By: Static

Deleted By: Static

Requirement: Mandatory

Table 52 describes class CIM_HostedCollection (AdminDomain to Collection).

Table 52 - SMI Referenced Properties/Methods for CIM_HostedCollection (AdminDomain to Collection)

Properties	Flags	Requirement	Description & Notes
Antecedent		Mandatory	Reference to the Fabric AdminDomain (OtherIdentifyingInfo contains 'Fabric' with a corresponding 'SNIA:DetailedType' in IdentifyingDescriptions').
Dependent		Mandatory	Reference to the NamedAddressCollection representing the Zone Alias.

5.7.4 CIM_HostedCollection (ComputerSystem to Collection)

Associates the NamedAddressCollection representing the Zone Alias to the ComputerSystem representing the switch.

Created By: Static

Modified By: Static

Deleted By: Static

Requirement: Mandatory

Table 53 describes class CIM_HostedCollection (ComputerSystem to Collection).

Table 53 - SMI Referenced Properties/Methods for CIM_HostedCollection (ComputerSystem to Collection)

Properties	Flags	Requirement	Description & Notes
Antecedent		Mandatory	A reference to a Switch ComputerSystem.
Dependent		Mandatory	Reference to the NamedAddressCollection representing the Zone Alias.

5.7.5 CIM_MemberOfCollection

Associates NamedAddressCollection with Zone.

Created By: Static

Modified By: Static

Deleted By: Static

Requirement: Mandatory

Table 54 describes class CIM_MemberOfCollection.

Table 54 - SMI Referenced Properties/Methods for CIM_MemberOfCollection

Properties	Flags	Requirement	Description & Notes
Collection		Mandatory	
Member		Mandatory	

5.7.6 CIM_NamedAddressCollection

The Zone Alias.

Created By: Static
 Modified By: Static
 Deleted By: Static
 Requirement: Mandatory

Table 55 describes class CIM_NamedAddressCollection.

Table 55 - SMI Referenced Properties/Methods for CIM_NamedAddressCollection

Properties	Flags	Requirement	Description & Notes
InstanceID		Mandatory	Opaque.
CollectionAlias		Mandatory	The Zone Alias Name.

5.7.7 CIM_ZoneService (Zone Service)

The service that allows for all of the zoning configuration changes. The definition in this profile adds additional methods to the same service defined in Zone Control.

Created By: Static
 Modified By: Static
 Deleted By: Static
 Requirement: Mandatory

Table 56 describes class CIM_ZoneService (Zone Service).

Table 56 - SMI Referenced Properties/Methods for CIM_ZoneService (Zone Service)

Properties	Flags	Requirement	Description & Notes
SystemCreationClassName		Mandatory	The scoping System's CreationClassName.
SystemName		Mandatory	The scoping System's Name.
CreationClassName		Mandatory	The Class Name.
Name		Mandatory	Opaque.
CreateZoneAlias()		Mandatory	
AddZoneAlias()		Mandatory	

STABLE

STABLE**6 Zone Control Profile****6.1 Synopsis**

Profile Name: Zone Control (Component Profile)

Version: 1.8.0

Organization: SNIA

Central Class: ZoneService

Scoping Class: AdminDomain

Related Profiles: Not defined in this document.

6.2 Description

This profile includes extrinsic methods for creating Zone Sets, Zones, and Zone Members and adding Zones to Zone Sets and Zone Members to Zones. Additionally SMI-S defines intrinsic methods for the removing of Zone Members from Zones and Zone Aliases, Zones from Zone Sets, and deleting Zone Members, Zones, and Zone Sets. The profile also includes methods to allow a client to request or release a lock on the fabric for zoning configuration changes.

When an Inactive ZoneSet is “Activated”, new instances representing the Active Zone Set and Active Zones are generated from the Inactive Zone Set definition (where a switch may prune the referenced Zone Set collapsing aliases, removes empty zones, etc.).

When a new Zone Set is “Activated”, the instances representing the previous active Zone Set no longer exists.

This profile also includes the property ConfigurationID on the ZoneService. The ConfigurationID is used to identify a unique point in time identifier of the zoning configuration. It may be a timestamp, a generation identifier, or a checksum. The ConfigurationID shall change whenever the zoning configuration changes. The value of the property is used as an input to ActivateZoneSet() and SessionControl() to allow the client to confirm that the change requested are consistent with the last discovery the client made of the zoning configuration.

In the case where the Inactive Zone Sets are hosted on a switch, the client cannot know which Inactive Zone Set was used to define the current Active Zone Set. Also if two Inactive Zone Sets with the same name are hosted on two different switches, the definitions maybe completely different.

6.3 Durable Names and Correlatable IDs of the Profile

Not defined in this document

6.4 Instrumentation Requirements

The agent shall support the use case defined in 6.8.

6.5 Health and Fault Management

Not defined in this document

6.6 Cascading Considerations

Not defined in this document

6.7 Methods of this Profile

6.7.1 CreateZoneSet

The method creates a ZoneSet and associates it to the System (AdminDomain representing the Fabric or the ComputerSystem representing the Switch) that the ZoneService is hosted on.

```
CreateZoneSet (
    [IN] string ZoneSetName,
    [OUT] CIM_ZoneSet ref ZoneSet);
```

6.7.2 CreateZone

The method creates a Zone and associates it to System (AdminDomain representing the Fabric or the ComputerSystem representing the Switch) that the ZoneService is hosted on.

```
CreateZone (
    [IN] string ZoneName,
    [IN] uint16 ZoneType,
    [IN] uint16 ZoneSubType,
    [OUT] CIM_Zone ref Zone);
```

6.7.3 CreateZoneMembershipSettingData

The method creates a ZoneMembershipSettingData (a zone member) and adds it to the specified Zone or NamedAddressCollection representing a Zone Alias. The ConnectivityMemberID is dependent upon the ConnectivityMemberType.

For Fibre Channel, the ConnectivityMemberType of "PermanentAddress", the ConnectivityMemberID is the NxPort WWN; for ConnectivityMemberType of "NetworkAddress", the ConnectivityMemberID is the NXPort Address ID; for ConnectivityMemberType of "SwitchPortID", the ConnectivityMemberID is "Domain:PortNumber".

```
CreateZoneMembershipSettingData (
    [IN] uint16 ConnectivityMemberType,
    [IN] string ConnectivityMemberID,
    [IN] CIM_SystemSpecificCollection ref SystemSpecificCollection,
    [OUT] CIM_ZoneMembershipSettingData ref ZoneMembershipSettingData);
```

6.7.4 AddZone

The method adds to the specified ZoneSet the specified Zone. Adding a Zone to a ZoneSet, extends the zone enforcement definition of the ZoneSet to include the members of that Zone. If adding the Zone is, successful, the Zone should be associated to the ZoneSet by MemberOfCollection.

```
AddZone (
    [IN] CIM_ZoneSet ref ZoneSet,
    [IN] CIM_Zone ref Zone);
```

6.7.5 AddZoneMembershipSettingData

The method adds to the specified Zone or NamedAddressCollection representing the Zone Alias the specified ZoneMembershipSettingData (a zone member).

```
AddZoneMembershipSettingData (
    [IN] CIM_SystemSpecificCollection ref SystemSpecificCollection,
    [IN] CIM_ZoneMembershipSettingData ref ZoneMembershipSettingData);
```

EXPERIMENTAL

6.7.6 ActivateZoneSetWithJob

This method activates the specified ZoneSet with the expectation that a job will be created. It has an optional input, ConfigurationID, which is used to confirm that the ZoneSet being activated matches the definition the application previously discovered or changed. If the ConfigurationID passed in matches the ConfigurationID associated to the current zone definitions, then the fabric attempts to activate the ZoneSet. If the ConfigurationIDs do not match, the method exits without activating the ZoneSet. Once a ZoneSet is activated, a ZoneSet with the property Active set to true, its associated Zones with the property Active set to true, and the Zone's associated ZoneMembershipSettingData are instantiated.

This method may run asynchronously due to the length of the operation. This typically occurs when the session is ended and the changes are committed. When the method is run asynchronously, the value "Method parameters checked - job started" is returned and the output parameter Job is populated with a reference to the job instance.

ActivateZoneSet shall be supported outside of a session. ActivateZoneSet being called within a session is implementation specific.

Calling ActivateZoneSet outside of a session while a session is open is implementation specific.

```
uint32 ActivateZoneSetWithJob (
    [IN] CIM_ZoneSet ref ZoneSet,
    [IN] boolean Activate,
    [IN,OUT] string ConfigurationID,
    [OUT] CIM_ConcreteJob REF Job,
    [IN] datetime TimeoutPeriod)
```

EXPERIMENTAL

6.7.7 ActivateZoneSet

This method activates the specified ZoneSet without a Job. ActivateZoneSetWithJob replaces this method. It is supported for backwards compatibility and should not be used in future implementations.

Once a ZoneSet is activated, a ZoneSet with the property Active set to true, its associated Zones with the property Active set to true, and the Zone's associated ZoneMembershipSettingData are instantiated.

ActivateZoneSet shall be supported outside of a session. ActivateZoneSet being called within a session is implementation specific.

Calling ActivateZoneSet outside of a session while a session is open is implementation specific.

```
uint32 ActivateZoneSet (
    [IN] CIM_ZoneSet ref ZoneSet,
    [IN] boolean Activate )
```

EXPERIMENTAL

6.7.8 SessionControlWithJob

This method allows a client to request or release a lock on the fabric for zoning configuration changes. The method has an optional input, ConfigurationID, which is used to confirm that the ZoneSet being activated matches the definition the application previously discovered or changed. If the ConfigurationID passed in matches the ConfigurationID associated to the current zone definitions, then the fabric attempts to grant the lock. If the ConfigurationIDs do not match, the method exits without attempting to have the fabric grant the lock.

As described in FC-GS, in the context of Enhanced Zoning Management, management actions to a Zone Server (e.g., write access to the Zoning Database) shall occur only inside a GS session. Clients executing zoning management operations shall use fabric sessions cooperatively if the SMI-S agent supports it. (If the value of SessionState is 4 (“Not Applicable”) then no cooperative session usage is possible).

Before a client executes zoning management operations (intrinsic or extrinsic methods), the client shall request a new session and wait for the request to be granted. To request a new session, first wait until the property “SessionState” of the fabric’s ZoneService is 3 (“Ended”) and the property “RequestedSessionState” is 5 “No Change”. Then call SessionControl with RequestedSessionState = 2 (“Started”). Once zoning management operations are completed, the client shall release the session to enable the provider to propagate changes to the fabric, and to allow other clients to perform management operations. To end a session and commit the changes, call SessionControl with RequestedSessionState = 3 (“Ended”). To abort a sequence of zoning management operations without updating the fabric, call SessionControl with RequestedSessionState = 4 (“Terminated”).

SMI-S agents shall block on calls to SessionControl until the request is fulfilled. For example, an error may occur while committing changes to a fabric, i.e., after a call to SessionControl with RequestedSessionState = 3 (“Ended”). The method cannot return until the session has ended, so that a CIM error can be returned if a problem occurs. While the method is in progress, another client may read the value of the RequestedSessionState property and see the value set by the method currently in progress. Once the request is fulfilled, the RequestedSessionState property is set to value 5 “No Change”, regardless of the value in the setInstance operation.

Sessions can timeout. The session timeout behavior and settings are defined by FC-SW in the section discussing mapping GS sessions for Enhanced Zoning Management.

This method may run asynchronously due to the length of the operation. This shall occur when the session is “Ended” to commit the changes. It shall not be used for any other case. When the method is run asynchronously, the value “Method parameters checked - job started” is returned and the output parameter Job is populated with a reference to the job instance.

A SMIS agent may raise an error if these client cooperation rules are not followed. For the purposes of a SMIS agent, a series of requests from the same authenticated entity are considered to be from a single client. An agent may verify that such a series corresponds to the sequence described above and raise the error CIM_ERR_FAILED at any time if the sequence is violated.

```
uint32 SessionControlWithJob (
    [IN,
        ValueMap {"2", "3", "4"},
        Values {"Started", "Ended", "Terminated"}]
    uint16 RequestedSessionState,
    [IN,OUT] string ConfigurationID,
    [OUT] CIM_ConcreteJob REF Job,
```

[IN] datetime TimeoutPeriod)

EXPERIMENTAL

6.7.9 SessionControl

The method enables a client to request a lock of the fabric to begin zoning configuration changes. It is supported for legacy implementations. SessionControlWithJob replaces this method. It is supported for backwards compatibility only and should not be used in future implementations.

This method allows a client to request or release a lock on the fabric for zoning configuration changes. As described in FC-GS, in the context of Enhanced Zoning Management, management actions to a Zone Server (e.g., write access to the Zoning Database) shall occur only inside a GS session. Clients executing zoning management operations shall use fabric sessions cooperatively if the SMI-S agent supports it. (If the value of SessionState is 4 (“Not Applicable”) then no cooperative session usage is possible).

Before a client executes zoning management operations (intrinsic or extrinsic methods), the client shall request a new session and wait for the request to be granted. To request a new session, first wait until the property “SessionState” of the fabric’s ZoneService is 3 (“Ended”) and the property “RequestedSessionState” is 5 “No Change”. Then call SessionControl with RequestedSessionState = 2 (“Started”). Once zoning management operations are completed, the client shall release the session to enable the provider to propagate changes to the fabric, and to allow other clients to perform management operations. To end a session and commit the changes, call SessionControl with RequestedSessionState = 3 (“Ended”). To abort a sequence of zoning management operations without updating the fabric, call SessionControl with RequestedSessionState = 4 (“Terminated”).

SMIS agents shall block on calls to SessionControl until the request is fulfilled. For example, an error may occur while committing changes to a fabric, i.e., after a call to SessionControl with RequestedSessionState = 3 (“Ended”). The method cannot return until the session has ended, so that a CIM error can be returned if a problem occurs. While the method is in progress, another client may read the value of the RequestedSessionState property and see the value set by the method currently in progress. Once the request is fulfilled, the RequestedSessionState property is set to value 5 “No Change”, regardless of the value in the setInstance operation.

Sessions can timeout. The session timeout behavior and settings are defined by INCITS FC-SW in the section discussing mapping GS sessions for Enhanced Zoning Management.

A SMIS agent may raise an error if these client cooperation rules are not followed. For the purposes of a SMIS agent, a series of requests from the same authenticated entity are considered to be from a single client. An agent may verify that such a series corresponds to the sequence described above and raise the error CIM_ERR_FAILED at any time if the sequence is violated.

```
uint32 SessionControl (
    [IN,
    ValueMap {"2", "3", "4"},
    Values {"Started", "Ended", "Terminated"}]
    uint16 RequestedSessionState);
```

6.7.10 Intrinsic for removing a zone from a zone set

As shown in Figure 9: "Zoning Instance (AdminDomain)" in the Fabric Profile, a zone is a member of a zone set if there is a “CIM_MemberOfCollection” association from the zone set to the zone. To remove a zone from a zone set, delete the instance of the association “CIM_MemberOfCollection” using the intrinsic operation deleteInstance.

6.7.11 Intrinsic for removing a zone alias from a zone

A zone alias is a member of a zone if there is a “CIM_MemberOfCollection” association from the zone to the zone alias. To remove a zone alias from a zone set, delete the instance of the association “CIM_MemberOfCollection” using the intrinsic operation deleteInstance.

6.7.12 Intrinsic for removing a zone member from a zone or zone alias

Zone members are represented by CIM_ZoneMembershipSettingData instances. No instance of CIM_ZoneMembershipSettingData exists unless it is associated to a zone or zone alias by a CIM_ElementSettingData association. However, an instance of CIM_ZoneMembershipSettingData may be associated to more than one zone or zone alias.

Removing a zone member from a zone or zone alias is equivalent to deleting the instance of the CIM_ElementSettingData association. Delete the instance using the intrinsic operation deleteInstance.

If this is the last instance of a CIM_ElementSettingData association for a particular CIM_ZoneMembershipSettingData, do not delete the instance of CIM_ZoneMembershipSettingData; it is the provider's responsibility to clean up these structures.

6.7.13 Intrinsic for deleting a zone member

Zone members are represented by CIM_ZoneMembershipSettingData instances associated to zones or zone aliases via CIM_ElementSettingData associations. To delete a zone member (and remove it from any zones or zone aliases from which it is a member) use the CIM operation deleteInstance to delete the instance of CIM_ZoneMembershipSettingData.

Do not delete the corresponding instances of the CIM_ElementSettingData; it is the provider's responsibility to clean up these structures.

6.7.14 Intrinsic for deleting a zone, zone alias, or zone set

Use the intrinsic operation deleteInstance to delete a zone, zone alias or zone set. Client are allowed to delete zones or zone aliases that are members of collections (zones or zone sets). Clients are allowed to delete the last member of a zone or zone set, leaving the collection empty.

A zone set or zone cannot be deleted if it is currently active (the error would be CIM_ERR_FAILED). Some implementations may prohibit deleting zonesets, zones or zone aliases that still have members (the error would be CIM_ERR_FAILED). When a zone, zone alias or zone set is deleted, the client does not have to delete the corresponding instances of CIM_MemberOfCollection or CIM_HostedCollection; it is the provider's responsibility to clean up these structures.

EXPERIMENTAL

6.7.15 AddZoneMembershipSettingDataWithRole

This method is used when defining peer zones adding to the specified Zone or ZoneAlias, the specified ZoneMembershipSettingData along with its role in the peer zone. If adding the ZoneMembershipSettingData is successful, an ElementSettingData association will be created between the ZoneMembershipSettingData and either the Zone or ZoneAlias.

```
AddZoneMembershipSettingDataWithRole(  
    [IN] CIM_SystemSpecificCollection REF SystemSpecificCollection,  
    [IN] CIM_ZoneMembershipSettingData REF ZoneMembershipSettingData,  
    [IN] uint16 ZoneMembershipRole);
```

6.7.16 CreateZoneMembershipSettingDataWithRole

This method creates a ZoneMembershipSettingData instance for a peer zone with its role and adds it to the specified Zone or ZoneAlias by creating a MemberOfCollection association.

```
CreateZoneMembershipSettingDataWithRole(
    [IN] uint16 ConnectivityMemberType,
    [IN] uint16 ConnectivityMemberRole,
    [IN] string ConnectivityMemberID,
    [IN] CIM_SystemSpecificCollection REF SystemSpecificCollection,
    [IN] CIM_ZoneMembershipSettingData REF ZoneMembershipSettingData);
```

EXPERIMENTAL

6.8 Use Cases

Many agent implementations do not allow Zone, a ZoneAlias or a Zone Set to be defined empty. Since the methods defined in SMI-S do not support creating a Zone Set with a Zone and a Zone with a Zone Member, the SessionControl method should be used to build a Zone Definition that is interoperable. This is done by calling ZoneSession() to “Start” defining or updating the Zone Definition. The client then calls the appropriate methods as necessary to build the desired Zone Definition. For example, calling CreateZoneSet() to create a new Zone Set, CreateZone() to create a new Zone, AddZoneToZoneSet() to add the newly created Zone to the newly created Zone Set, and CreateZoneMembershipSettingData() to create and add a new Zone Member to the newly created Zone. Upon completion of the new zoning definition, ZoneControl is called again to “End” the session. The changes to the Zone Definition would then be applied to the Zone Set Database. This set of calls would create a Zone Definition where the Zone and ZoneSet are not empty and would be interoperable across all agent implementations.

No recipes are defined in this version of the standard.

6.9 CIM Elements

6.9.1 Overview

Table 57 describes the CIM elements for Zone Control.

Table 57 - CIM Elements for Zone Control

Element Name	Requirement	Description
6.9.2 CIM_HostedService (Fabric (AdminDomain) to ZoneService)	Optional	Associates the ZoneService to the AdminDomain representing the fabric.
6.9.3 CIM_HostedService (Switch (ComputerSystem) to ZoneService)	Optional	Associates the ZoneService to the ComputerSystem representing the switch.
6.9.4 CIM_ZoneService (Zone Service)	Mandatory	The service that allows for all of the zoning configuration changes.

6.9.2 CIM_HostedService (Fabric (AdminDomain) to ZoneService)

Associates the ZoneService to the AdminDomain representing the fabric.

Created By: Static

Modified By: Static

Deleted By: Static

Requirement: Optional

Table 58 describes class CIM_HostedService (Fabric (AdminDomain) to ZoneService).

Table 58 - SMI Referenced Properties/Methods for CIM_HostedService (Fabric (AdminDomain) to ZoneService)

Properties	Flags	Requirement	Description & Notes
Antecedent		Mandatory	The reference to the AdminDomain representing the fabric (OtherIdentifyingInfo contains 'Fabric' with a corresponding 'SNIA:DetailedType' in IdentifyingDescriptions').
Dependent		Mandatory	The reference to the ZoneService.

6.9.3 CIM_HostedService (Switch (ComputerSystem) to ZoneService)

Associates the ZoneService to the ComputerSystem representing the switch.

Created By: Static

Modified By: Static

Deleted By: Static

Requirement: Optional

Table 59 describes class CIM_HostedService (Switch (ComputerSystem) to ZoneService).

Table 59 - SMI Referenced Properties/Methods for CIM_HostedService (Switch (ComputerSystem) to ZoneService)

Properties	Flags	Requirement	Description & Notes
Antecedent		Mandatory	The reference to the ComputerSystem representing the switch.
Dependent		Mandatory	The reference to the ZoneService.

6.9.4 CIM_ZoneService (Zone Service)

The service that allows for all of the zoning configuration changes.

Created By: Static

Modified By: Static

Deleted By: Static

Requirement: Mandatory

Table 60 describes class CIM_ZoneService (Zone Service).

Table 60 - SMI Referenced Properties/Methods for CIM_ZoneService (Zone Service)

Properties	Flags	Requirement	Description & Notes
SystemCreationClassName		Mandatory	The scoping System's CreationClassName.
SystemName		Mandatory	The scoping System's Name.
CreationClassName		Mandatory	The Class Name.
Name		Mandatory	Opaque.
OperationalStatus		Mandatory	Status of Zoning Service.
SessionState		Mandatory	State of session. Valid values are "Starting", "Ended".

Table 60 - SMI Referenced Properties/Methods for CIM_ZoneService (Zone Service)

Properties	Flags	Requirement	Description & Notes
RequestedSessionState		Mandatory	The requested session state from the client. The valid values that can be set are "Start", "End", and "Terminate".
DefaultZoningState		Mandatory	
CreateZoneSet()		Mandatory	The method creates a ZoneSet and associates it to the System (AdminDomain representing the Fabric or the ComputerSystem representing the Switch) that the ZoneService is hosted on.
CreateZone()		Mandatory	The method creates a Zone and associates it to System (AdminDomain representing the Fabric or the ComputerSystem representing the Switch) that the ZoneService is hosted on.
CreateZoneMembershipSettingData()		Mandatory	The method creates a ZoneMembershipSettingData (a zone member) and adds it to the specified Zone or NamedAddressCollection representing a Fibre Channel Node.
AddZone()		Mandatory	The method adds to the specified ZoneSet the specified Zone.
AddZoneMembershipSettingData()		Mandatory	The method adds to the specified Zone or NamedAddressCollection representing the Fibre Channel Node the specified ZoneMembershipSettingData (a zone member).
ActivateZoneSet()		Mandatory	The method activates the specified ZoneSet.
SessionControl()		Mandatory	The method enables a client to request a lock of the fabric to begin zoning configuration changes.
AddZoneMembershipSettingDataWithRole()		Optional	Experimental. This method is used when defining peer zones adding to the specified Zone or ZoneAlias, the specified ZoneMembershipSettingData along with its role in the peer zone.
CreateZoneMembershipSettingDataWithRole()	Optional	Optional	Experimental. This method creates a ZoneMembershipSettingData instance for a peer zone with its role and adds it to the specified Zone or ZoneAlias by creating a ZoneSettingData association.

IMPLEMENTED

7 FDMI Profile

7.1 Synopsis

Profile Name: FDMI (Component Profile)

Version: 1.8.0

Organization: SNIA

Central Class: ComputerSystem

Scoping Class: an AdminDomain in a referencing autonomous profile

Related Profiles: Not defined in this document.

7.2 Description

The Fabric-Device Management Interface (FDMI) enables the management of devices such as HBAs through the Fabric. The FDMI complements data in the Fabric Profile. It allows for any entity in the Fabric to expose through SMI the HBA information without having an agent resident on the Host containing the HBA. Figure 12 shows an FDMI instance.

This profile only addresses HBA type devices. The HBA Management Interface defined by FDMI is a subset of interface defined by the Fibre Channel HBA API specification, as exposed by *Storage Management Technical Specification, Part 7 Host Elements, 1.8.0 Rev 4 5 FC HBA Profile*.

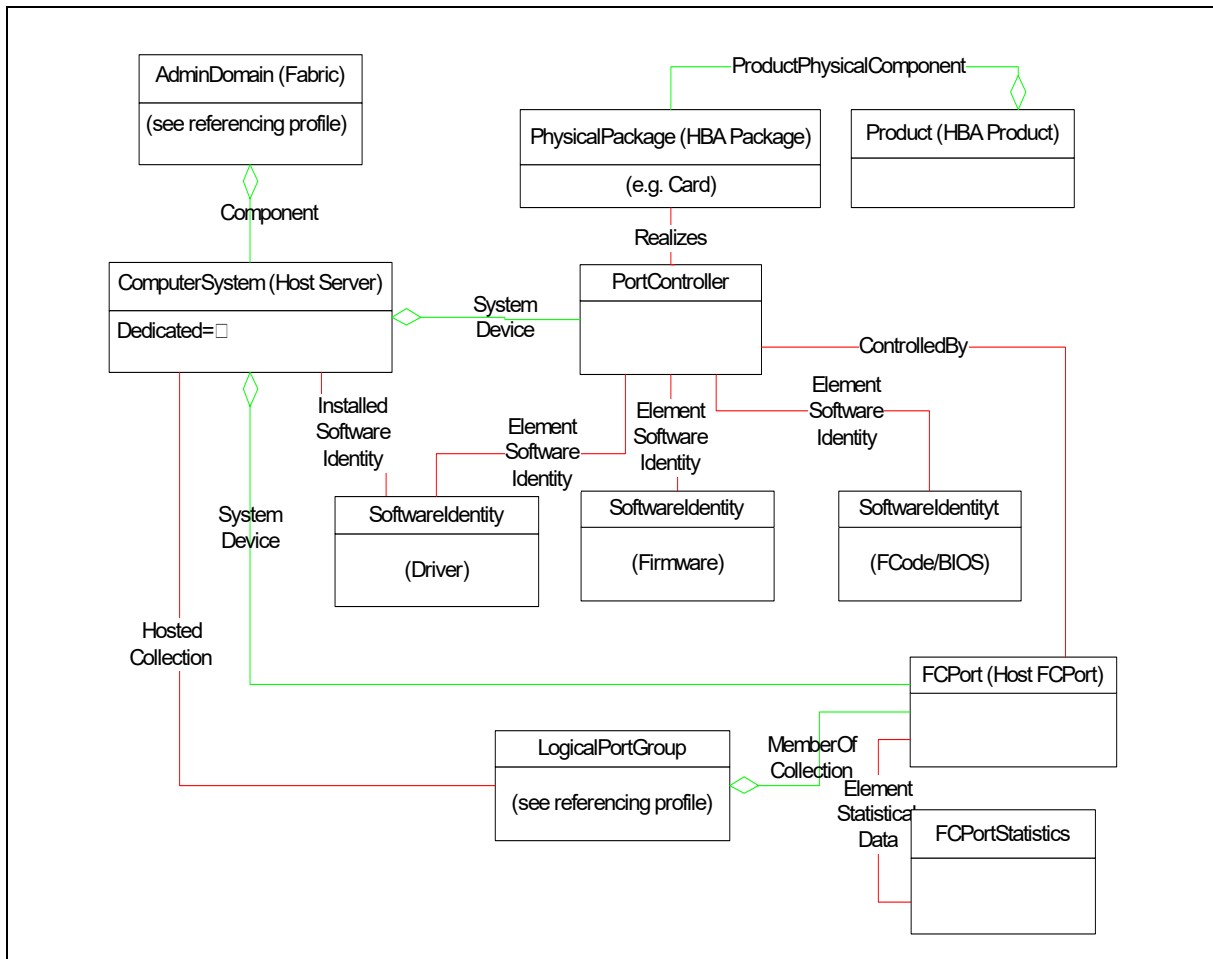

Figure 12 - FDMI Instance

7.3 Health and Fault Management

Not defined in this document

7.4 Cascading Considerations

Not defined in this document

7.5 Methods of this Profile

Not defined in this document

7.6 Use Cases

Not defined in this document.

7.7 CIM Elements

7.7.1 Overview

Table 61 describes the CIM elements for FDMI.

Table 61 - CIM Elements for FDMI

Element Name	Requirement	Description
7.7.2 CIM_Component (Host Server to Fabric)	Mandatory	Aggregates Hosts (Platforms) in the AdminDomain that represents the Fabric.
7.7.3 CIM_ComputerSystem (Host Server)	Mandatory	The System the HBA is within.
7.7.4 CIM_ControlledBy	Mandatory	Associates the FCPorts of the Host Server with the PortController.
7.7.5 CIM_ElementSoftwareIdentity	Mandatory	Associates the SoftwareIdentity to the HBA.
7.7.6 CIM_FCPort (Host FCPort)	Mandatory	The HBA Fibre Channel Port.
7.7.7 CIM_HostedCollection (System to LogicalPortGroup)	Mandatory	Associates the LogicalPortGroup (Fibre Channel Node) to the hosting System.
7.7.8 CIM_InstalledSoftwareIdentity	Mandatory	Associates the SoftwareIdentity representing the driver to the System it is installed on.
7.7.9 CIM_MemberOfCollection (LogicalPortGroup to FCPort)	Mandatory	Associates FCPort to the LogicalPortGroup.
7.7.10 CIM_PhysicalPackage (HBA Package)	Mandatory	The physical package that the HBA is contained in.
7.7.11 CIM_PortController	Mandatory	The HBA.
7.7.12 CIM_Product (HBA Product)	Mandatory	The product information for the HBA.
7.7.13 CIM_ProductPhysicalComponent	Mandatory	Associates the Product to the PhysicalPackage.
7.7.14 CIM_Realizes	Mandatory	Associates the PhysicalPackage to the PortController.
7.7.15 CIM_SoftwareIdentity (Driver)	Mandatory	The software for the driver.
7.7.16 CIM_SoftwareIdentity (Firmware)	Mandatory	The software for the firmware.
7.7.17 CIM_SoftwareIdentity (Option ROM)	Mandatory	The software for the Option ROM.
7.7.18 CIM_SystemDevice (ComputerSystem to FCPort)	Mandatory	Associates the FCPort to the Host Server ComputerSystem.
7.7.19 CIM_SystemDevice (ComputerSystem to PortController)	Mandatory	Associates the Host Server ComputerSystem with the PortController.

7.7.2 CIM_Component (Host Server to Fabric)

Aggregates Hosts (Platforms) in the AdminDomain that represents the Fabric.

Created By: Static

Modified By: Static

Deleted By: Static

Requirement: Mandatory

Table 62 describes class CIM_Component (Host Server to Fabric).

Table 62 - SMI Referenced Properties/Methods for CIM_Component (Host Server to Fabric)

Properties	Flags	Requirement	Description & Notes
PartComponent		Mandatory	Reference to a Host Server ComputerSystem.
GroupComponent		Mandatory	Reference to the AdminDomain representing the Fabric.

7.7.3 CIM_ComputerSystem (Host Server)

The system the HBA is within. It is identified using Host Name from the FDMI interface.

Created By: Static

Modified By: Static

Deleted By: Static

Requirement: Mandatory

Table 63 describes class CIM_ComputerSystem (Host Server).

Table 63 - SMI Referenced Properties/Methods for CIM_ComputerSystem (Host Server)

Properties	Flags	Requirement	Description & Notes
CreationClassName		Mandatory	Name of Class.
Name		Mandatory	The FDMI name of the host containing the Device. The key identifier helping in discovery to determine which HBAs are in the same host.
ElementName		Mandatory	The Platform Label.
NameFormat		Mandatory	
Dedicated		Mandatory	For a FC-GS Platform Type of Host, this shall be 'Not Dedicated' (0).

7.7.4 CIM_ControlledBy

Associates the FCPorts of the Host Server with the PortController.

Created By: Static

Modified By: Static

Deleted By: Static

Requirement: Mandatory

Table 64 describes class CIM_ControlledBy.

Table 64 - SMI Referenced Properties/Methods for CIM_ControlledBy

Properties	Flags	Requirement	Description & Notes
Dependent		Mandatory	A reference to an instance of a Host Server FCPort.
Antecedent		Mandatory	The reference to the PortController.

7.7.5 CIM_ElementSoftwareIdentity

Associates the SoftwareIdentities representing the various software for the HBA to the PortController representing the HBA.

Created By: Static

Modified By: Static

Deleted By: Static

Requirement: Mandatory

Table 65 describes class CIM_ElementSoftwareIdentity.

Table 65 - SMI Referenced Properties/Methods for CIM_ElementSoftwareIdentity

Properties	Flags	Requirement	Description & Notes
Antecedent		Mandatory	A reference to an instance of software (Firmware, Driver or Option ROM).
Dependent		Mandatory	A reference to the HBA PortController.

7.7.6 CIM_FCPort (Host FCPort)

The HBA Fibre Channel Port.

Created By: Static

Modified By: Static

Deleted By: Static

Requirement: Mandatory

Table 66 describes class CIM_FCPort (Host FCPort).

Table 66 - SMI Referenced Properties/Methods for CIM_FCPort (Host FCPort)

Properties	Flags	Requirement	Description & Notes
SystemCreationClassName		Mandatory	The scoping System's CreationClassName.
SystemName		Mandatory	The scoping System's Name.
CreationClassName		Mandatory	Name of Class.
DeviceID		Mandatory	Opaque.
ElementName		Mandatory	Port Symbolic Name if available. Otherwise NULL. If the underlying implementation includes characters that are illegal in CIM strings, then truncate before the first of those characters.
LinkTechnology		Mandatory	'FC'.
PermanentAddress		Mandatory	Fibre Channel Port WWN.
NetworkAddresses	C	Mandatory	Fibre Channel ID (FCID). Expressed as 8 un-separated upper case hex digits.
ActiveFC4Types		Mandatory	The active Fibre Channel FC-4 protocol.

Table 66 - SMI Referenced Properties/Methods for CIM_FCPort (Host FCPort)

Properties	Flags	Requirement	Description & Notes
SupportedFC4Types		Optional	An array of integers indicating the Fibre Channel FC-4 protocols supported EXPERIMENTAL When supporting FC-SB, this property shall be either '27' (FC-SB-2 Channel) for Host Ports or '28' (FC-SB-2 Control Unit) for targets.
SupportedCOS		Optional	An array of integers indicating the Fibre Channel Classes of Service that are supported.
PortType		Mandatory	The specific port type currently enabled (from FC-GS Port.Type).
Speed		Optional	Experimental. Speed of zero represents a link not established. 1 GFC is 1062500000 bps 2 GFC is 2125000000 bps 4 GFC is 4250000000 bps 8 GFC = 8500000000 bps 10 GFC single channel variants are 10518750000 bps 10 GFC four channel variants are 12750000000 bps 16 GFC = 14025000000 bps 32 GFC = 28500000000 bps 128 GFC = 114000000000 bps This is the raw bit rate.

7.7.7 CIM_HostedCollection (System to LogicalPortGroup)

Associates the LogicalPortGroup (Fibre Channel Node) to the hosting System.

Created By: Static

Modified By: Static

Deleted By: Static

Requirement: Mandatory

Table 67 describes class CIM_HostedCollection (System to LogicalPortGroup).

Table 67 - SMI Referenced Properties/Methods for CIM_HostedCollection (System to LogicalPortGroup)

Properties	Flags	Requirement	Description & Notes
Antecedent		Mandatory	The Host Server ComputerSystem.
Dependent		Mandatory	The LogicalPortGroup.

7.7.8 CIM_InstalledSoftwareIdentity

Associates the SoftwareIdentity representing the driver to the System it is installed on.

Created By: Static

Modified By: Static
 Deleted By: Static
 Requirement: Mandatory

Table 68 describes class CIM_InstalledSoftwareIdentity.

Table 68 - SMI Referenced Properties/Methods for CIM_InstalledSoftwareIdentity

Properties	Flags	Requirement	Description & Notes
InstalledSoftware		Mandatory	A reference to Driver Software.
System		Mandatory	A reference to the Host Server ComputerSystem.

7.7.9 CIM_MemberOfCollection (LogicalPortGroup to FCPort)

Associates FCPort to the LogicalPortGroup.

Created By: Static
 Modified By: Static
 Deleted By: Static
 Requirement: Mandatory

Table 69 describes class CIM_MemberOfCollection (LogicalPortGroup to FCPort).

Table 69 - SMI Referenced Properties/Methods for CIM_MemberOfCollection (LogicalPortGroup to FCPort)

Properties	Flags	Requirement	Description & Notes
Collection		Mandatory	A reference to a LogicalPortGroup on the Host Server.
Member		Mandatory	A reference to an FCPort on the Host Server.

7.7.10 CIM_PhysicalPackage (HBA Package)

The physical package that the HBA is contained by. It can be simply a PhysicalPackage that the system and HBA is contained within. If it is known that the HBA is on a separate board, Card (a subclass of PhysicalPackage) can be used.

Created By: Static
 Modified By: Static
 Deleted By: Static
 Requirement: Mandatory

Table 70 describes class CIM_PhysicalPackage (HBA Package).

Table 70 - SMI Referenced Properties/Methods for CIM_PhysicalPackage (HBA Package)

Properties	Flags	Requirement	Description & Notes
CreationClassName		Mandatory	Name of Class.
Tag		Mandatory	An arbitrary string that uniquely identifies the PhysicalPackage.
ElementName		Optional	User Friendly name. This property is OPTIONAL.

Table 70 - SMI Referenced Properties/Methods for CIM_PhysicalPackage (HBA Package)

Properties	Flags	Requirement	Description & Notes
Name		Optional	
Manufacturer		Mandatory	
Model		Mandatory	
SerialNumber		Optional	
Version		Optional	
PartNumber		Optional	

7.7.11 CIM_PortController

The HBA. The HBA may have logical operations that can apply to it (e.g. OperationalStatus).

Created By: Static

Modified By: Static

Deleted By: Static

Requirement: Mandatory

Table 71 describes class CIM_PortController.

Table 71 - SMI Referenced Properties/Methods for CIM_PortController

Properties	Flags	Requirement	Description & Notes
SystemCreationClassName		Mandatory	
SystemName		Mandatory	
CreationClassName		Mandatory	
DeviceID		Mandatory	
ControllerType		Mandatory	

7.7.12 CIM_Product (HBA Product)

The product information for the HBA.

Created By: Static

Modified By: Static

Deleted By: Static

Requirement: Mandatory

Table 72 describes class CIM_Product (HBA Product).

Table 72 - SMI Referenced Properties/Methods for CIM_Product (HBA Product)

Properties	Flags	Requirement	Description & Notes
Name		Mandatory	Commonly used Product name.
IdentifyingNumber		Mandatory	Product identification such as a serial number.
Vendor		Mandatory	The manufacturer or the OEM.

Table 72 - SMI Referenced Properties/Methods for CIM_Product (HBA Product)

Properties	Flags	Requirement	Description & Notes
Version		Mandatory	Product version information.
ElementName		Mandatory	User Friendly name. Suggested use is Vendor, Version and product name.

7.7.13 CIM_ProductPhysicalComponent

Associates the Product to the PhysicalPackage. This is necessary to link the Product information to the HBA.

Created By: Static

Modified By: Static

Deleted By: Static

Requirement: Mandatory

Table 73 describes class CIM_ProductPhysicalComponent.

Table 73 - SMI Referenced Properties/Methods for CIM_ProductPhysicalComponent

Properties	Flags	Requirement	Description & Notes
GroupComponent		Mandatory	The product information (CIM_Product) for the HBA Package.
PartComponent		Mandatory	The Physical Package for the HBA.

7.7.14 CIM_Realizes

Associates the PhysicalPackage to the PortController.

Created By: Static

Modified By: Static

Deleted By: Static

Requirement: Mandatory

Table 74 describes class CIM_Realizes.

Table 74 - SMI Referenced Properties/Methods for CIM_Realizes

Properties	Flags	Requirement	Description & Notes
Antecedent		Mandatory	The Physical Package for the HBA.
Dependent		Mandatory	The PortController of the HBA.

7.7.15 CIM_SoftwareIdentity (Driver)

The software for the driver.

Created By: Static

Modified By: Static

Deleted By: Static

Requirement: Mandatory

Table 75 describes class CIM_SoftwareIdentity (Driver).

Table 75 - SMI Referenced Properties/Methods for CIM_SoftwareIdentity (Driver)

Properties	Flags	Requirement	Description & Notes
InstanceID		Mandatory	
VersionString		Mandatory	
Manufacturer		Mandatory	
BuildNumber		Optional	
MajorVersion		Optional	
RevisionNumber		Optional	
MinorVersion		Optional	
Classifications		Mandatory	

7.7.16 CIM_SoftwareIdentity (Firmware)

The software for the firmware.

Created By: Static

Modified By: Static

Deleted By: Static

Requirement: Mandatory

Table 76 describes class CIM_SoftwareIdentity (Firmware).

Table 76 - SMI Referenced Properties/Methods for CIM_SoftwareIdentity (Firmware)

Properties	Flags	Requirement	Description & Notes
InstanceID		Mandatory	
VersionString		Mandatory	
Manufacturer		Mandatory	
BuildNumber		Optional	
MajorVersion		Optional	
RevisionNumber		Optional	
MinorVersion		Optional	
Classifications		Mandatory	

7.7.17 CIM_SoftwareIdentity (Option ROM)

The software for the Option ROM.

Created By: Static

Modified By: Static

Deleted By: Static

Requirement: Mandatory

Table 77 describes class CIM_SoftwareIdentity (Option ROM).

Table 77 - SMI Referenced Properties/Methods for CIM_SoftwareIdentity (Option ROM)

Properties	Flags	Requirement	Description & Notes
InstanceID		Mandatory	
VersionString		Mandatory	
Manufacturer		Mandatory	
BuildNumber		Optional	
MajorVersion		Optional	
RevisionNumber		Optional	
MinorVersion		Optional	
Classifications		Mandatory	

7.7.18 CIM_SystemDevice (ComputerSystem to FCPort)

Associates the FCPort to the Host Server ComputerSystem.

Created By: Static

Modified By: Static

Deleted By: Static

Requirement: Mandatory

Table 78 describes class CIM_SystemDevice (ComputerSystem to FCPort).

Table 78 - SMI Referenced Properties/Methods for CIM_SystemDevice (ComputerSystem to FCPort)

Properties	Flags	Requirement	Description & Notes
PartComponent		Mandatory	A reference to a Host FCPort.
GroupComponent		Mandatory	A reference to the Host Server ComputerSystem.

7.7.19 CIM_SystemDevice (ComputerSystem to PortController)

Associates the Host Server ComputerSystem with the PortController.

Created By: Static

Modified By: Static

Deleted By: Static

Requirement: Mandatory

Table 79 describes class CIM_SystemDevice (ComputerSystem to PortController).

Table 79 - SMI Referenced Properties/Methods for CIM_SystemDevice (ComputerSystem to PortController)

Properties	Flags	Requirement	Description & Notes
PartComponent		Mandatory	A reference to the HBA PortController.
GroupComponent		Mandatory	A reference to the Host Server ComputerSystem.

IMPLEMENTED

EXPERIMENTAL

8 Fabric Views Profile

8.1 Description

8.1.1 Synopsis

Profile Name: Fabric Views (Component Profile)

Version: 1.7.0

Organization: SNIA

Central Class: CIM_ViewCapabilities

Scoping Class: a ComputerSystem in a referencing autonomous profile

Related Profiles: Not defined in this document.

8.1.2 Overview

This Profile specifies View Classes for the Fabric Profiles.

View classes provide an optimization of retrieval of information provided by multiple (associated) instances in a Profile. There is no support for update of view classes instances. Update of a view class instance can only be accomplished by updating the base class instances from which the view is derived.

8.1.3 Goals of View Classes

8.1.3.1 Intended Goals

Goals that view classes are intended to address are:

- Get more data in one call to CIM Server.

The CIM model for fabrics involve a number of classes and associations. The objective is to allow discovery of the fabric model using view classes with a reduction in the number of association traversals required.

- Allow providers to optimize the Request.

In many cases, the data represented by a view class is actually kept (and returned) by a device as one entity. When the "normalized" CIM model is traversed many calls are made to retrieve that one entity. The provider takes the data from the one entity and carves it up for each CIM request. In many cases this involves retrieving the same entity multiple times. The objective is to allow a Provider to return the single entity in one SMI-S request (for data that is typically kept together by the device).

8.1.3.2 Additional Goals

- Do more things in one call to CIM Server.

An example would be retrieval or discovery of model information with fewer calls. However, this goal also extends to updating the CIM model (e.g., configuration actions). The view classes are not intended to help in the latter case. However, view classes should facilitate access to underlying classes in support of configuration operations.

It is important to note that the view classes proposal was based directly on experiences relating to the scalability and performance of SMI-S real-world implementations. The focus is on improving performance in large configurations (e.g., thousands of volumes and thousands of disk drives).

8.1.4 Specific Requirements and Objectives of View Classes

8.1.4.1 Pre-defined View Classes

In order to gain the desired performance advantage, it is felt that view classes would have to be pre-defined (in SMI-S) to allow provider optimization of the requested information.

- Enable Associator Calls to View Class instances.

It should be possible to retrieve a view class by an associators call to the class.

However, it is desired that the association should be clearly distinguished from existing associations on the base classes.

- Enable Associator Calls from View Class instances.

It should be possible to get related classes (e.g., base classes) from the view class by using associator calls.

Again, the associations used should be clearly distinguished from existing associations on the base classes.

- Allow View Classes to be used where other classes are used.

This certainly includes "read" intrinsic and as parameters of Extrinsic

However, at this time "Write" intrinsic support is deferred and use in Extrinsic (as IN or OUT parameters) is not covered in this release of SMI-S.

8.1.4.2 Support Life Cycle Indications on View Classes

This requirement is being deferred for consideration in a future release of SMI-S.

8.1.5 Class Diagram for Fabric Views View Classes

Figure 13 illustrates the class diagram for the Fabric view classes.

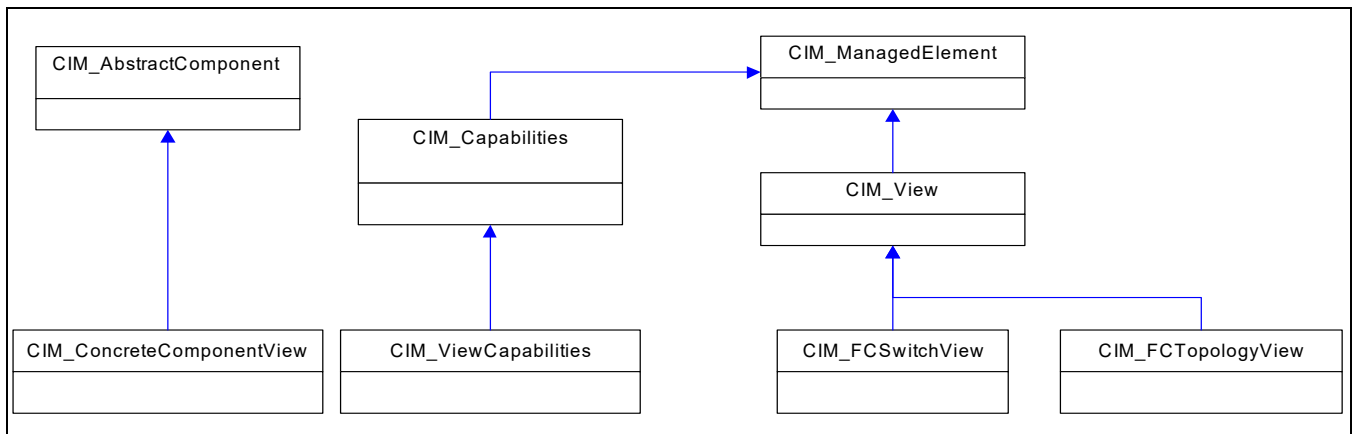

Figure 13 - Class Diagram for Fabric View Classes

The ViewCapabilities inherits from CIM_Capabilities. The FCSwitchView class inherits from CIM_View. The TopologyView class is a top level association class. The Fabric Views profile has one subclass of CIM_AbstractComponent: CIM_ConcreteComponentView. This associates the view to its scoping system.

8.1.6 View Class Capabilities

The implementation shall identify which view classes are implemented using a set of conditions. The model for determining whether or not the Fabric Views Profile is supported and which views are supported is illustrated in Figure 14: "Fabric View Class Capabilities".

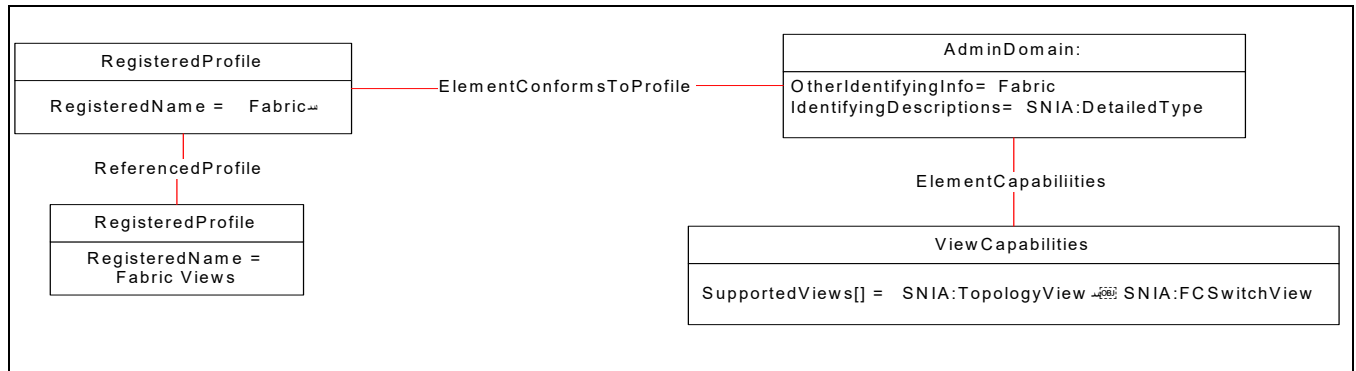

Figure 14 - Fabric View Class Capabilities

First a client may determine whether or not a profile implementation has implemented any view classes by looking for a RegisteredProfile with a RegisteredName of “Fabric Views”. If this RegisteredProfile exists then the profile supports some number of view classes.

Next a client would be able to determine which view classes are supported by an implementation by following the ElementConformsToProfile to the Fabric and then following the ElementCapabilities from the Fabric to the CIM_ViewCapabilities instance. There shall be one instance of the CIM_ViewCapabilities class for each Fabric if the profile supports the Fabric Views Profile. The CIM_ViewCapabilities instance shall have an array of strings (SupportedViews) that identify the view classes that are supported. For example, if the SupportedViews array includes the “SNIA:TopologyView” string, then the TopologyView class shall be supported.

8.1.7 Topology View

Discovering a topology for a large fibre channel fabric (thousands of ports) time-wise is expensive. The existing fabric profile requires traversals of three associations and two classes for each link. Using the view class reduces this to one enumeration of the view class itself for all links. The CIM_FCTopologyView, shown in Figure 15: "FCTopology View Class", provides the properties to be able

Support Life Cycle Indications on View Classes

to build a topology without having to do associators from the ProtocolEndpoint to the FCPort to the FCNode or FCSwitch.

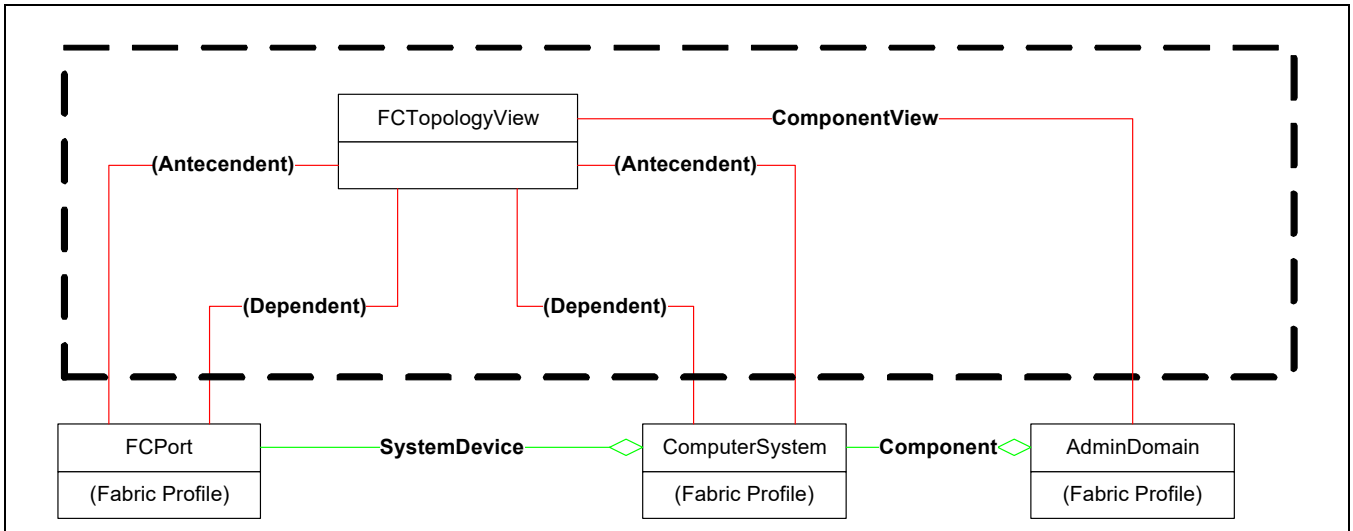

Figure 15 - FCTopology View Class

8.1.8 FCSwitch View

Discovering a fibre channel switch and its associated ports is expensive. The CIM_FCSwitchView, shown in Figure 16: "FCSwitch View Class", provides the properties to be able to discover all the switch properties for a Fibre Channel Switch and Ports without having to do associators from the ComputerSystem representing the Switch to FCPort, LogicalModule, Product, PhysicalPackage, SoftwareIdentity, FCSwitchCapabilities, FCPortCapabilities, AccessPoint, and Location.

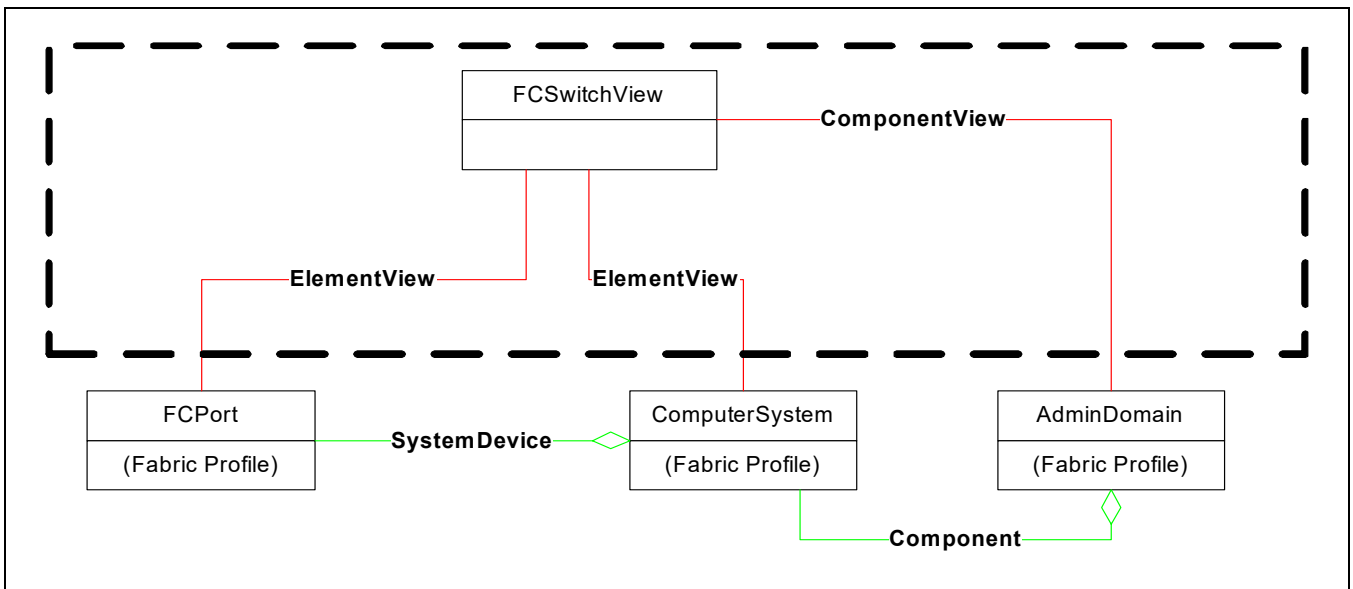

Figure 16 - FCSwitch View Class

8.2 Health and Fault Management Consideration

Not defined in this document

Support Life Cycle Indications on View Classes

8.3 Cascading Considerations

Not defined in this document

8.4 Methods of the Profile

Not defined in this document

8.5 Use Cases

Not defined in this document.

8.6 CIM Elements**8.6.1 Overview**

Table 80 describes the CIM elements for Fabric Views.

Table 80 - CIM Elements for Fabric Views

Element Name	Requirement	Description
8.6.2 CIM_ElementCapabilities (View Capabilities)	Mandatory	Associates the Fabric AdminDomain to the CIM_ViewCapabilities supported by the implementation.
8.6.3 CIM_ElementView (View to FC Port)	Conditional	Conditional requirement: Required if the array property CIM_ViewCapabilities.SupportedViews contains the string 'SNIA:FCSwitchView'. Associates the CIM_FCSwitchView instances to corresponding the FC Port instance.
8.6.4 CIM_ElementView (View to Switch)	Conditional	Conditional requirement: Required if the array property CIM_ViewCapabilities.SupportedViews contains the string 'SNIA:FCSwitchView'. Associates the CIM_FCSwitchView instances to corresponding the Fibre Channel Switch instance.
8.6.5 CIM_ViewCapabilities	Mandatory	The CIM_ViewCapabilities identifies the capabilities of the implementation of view classes.
8.6.6 CIM_ConcreteComponentView (FCSwitchView to Fabric)	Conditional	Conditional requirement: Required if the array property CIM_ViewCapabilities.SupportedViews contains the string 'SNIA:FCSwitchView'. Associates the Fabric AdminDomain to the CIM_FCSwitchView.
8.6.7 CIM_ConcreteComponentView (FCTopologyView to Fabric)	Conditional	Conditional requirement: Required if the array property CIM_ViewCapabilities.SupportedViews contains the string 'SNIA:TopologyView'. Associates the Fabric AdminDomain to the CIM_FCTopologyView.
8.6.8 CIM_FCSwitchView	Conditional	Conditional requirement: Required if the array property CIM_ViewCapabilities.SupportedViews contains the string 'SNIA:FCSwitchView'. The CIM_FCSwitchView provides the properties for a Fibre Channel Switch.
8.6.9 CIM_FCTopologyView	Conditional	Conditional requirement: Required if the array property CIM_ViewCapabilities.SupportedViews contains the string 'SNIA:TopologyView'. The CIM_FCTopologyView provides the properties to be able to build a topology for a Fibre Channel Fabric.

8.6.2 CIM_ElementCapabilities (View Capabilities)

Created By: Static

Modified By: Static

Support Life Cycle Indications on View Classes

Deleted By: Static
 Requirement: Mandatory

Table 81 describes class CIM_ElementCapabilities (View Capabilities).

Table 81 - SMI Referenced Properties/Methods for CIM_ElementCapabilities (View Capabilities)

Properties	Flags	Requirement	Description & Notes
Capabilities		Mandatory	The ViewCapabilities.
ManagedElement		Mandatory	The Fabric AdminDomain that has the ViewCapabilities.

8.6.3 CIM_ElementView (View to FC Port)

Associates the CIM_FCSwitchView instances to corresponding the FC Port instance.

Created By: Static
 Modified By: Static
 Deleted By: Static
 Requirement: Required if the array property CIM_ViewCapabilities.SupportedViews contains the string 'SNIA:FCSwitchView'.

Table 82 describes class CIM_ElementView (View to FC Port).

Table 82 - SMI Referenced Properties/Methods for CIM_ElementView (View to FC Port)

Properties	Flags	Requirement	Description & Notes
Antecedent		Mandatory	The base CIM_FCPort instance on which the CIM_FCSwitchView instance is based.
Dependent		Mandatory	The CIM_FCSwitchView instance that is based on the CIM_FCPort instance.

8.6.4 CIM_ElementView (View to Switch)

Associates the CIM_FCSwitchView instances to corresponding the Fibre Channel Switch instance.

Created By: Static
 Modified By: Static
 Deleted By: Static
 Requirement: Required if the array property CIM_ViewCapabilities.SupportedViews contains the string 'SNIA:FCSwitchView'.

Table 83 describes class CIM_ElementView (View to Switch).

Table 83 - SMI Referenced Properties/Methods for CIM_ElementView (View to Switch)

Properties	Flags	Requirement	Description & Notes
Antecedent		Mandatory	The base CIM_ComputerSystem (Switch) instance on which the CIM_FCSwitchView instance is based.
Dependent		Mandatory	The CIM_FCSwitchView instance that is based on the CIM_ComputerSystem (Switch) instance.

Support Life Cycle Indications on View Classes

8.6.5 CIM_ViewCapabilities

The CIM_ViewCapabilities instance defines the capabilities of an implementation support for view classes. The CIM_ViewCapabilities is subclassed from CIM_Capabilities.

Created By: Static

Modified By: Static

Deleted By: Static

Requirement: Mandatory

Table 84 describes class CIM_ViewCapabilities.

Table 84 - SMI Referenced Properties/Methods for CIM_ViewCapabilities

Properties	Flags	Requirement	Description & Notes
InstanceID		Mandatory	An opaque, unique id for the view class capability of an implementation.
ElementName		Optional	A provider supplied user-Friendly Name for this CIM_ViewCapabilities element.
SupportedViews		Mandatory	This array of strings lists the view classes that are supported by the implementation. Supported string values are 'SNIA:TopologyView' or 'SNIA:FCSwitchView'.

8.6.6 CIM_ConcreteComponentView (FCSwitchView to Fabric)

Associates the Fabric AdminDomain to the CIM_FCSwitchView.

Created By: Static

Modified By: Static

Deleted By: Static

Requirement: Required if the array property CIM_ViewCapabilities.SupportedViews contains the string 'SNIA:FCSwitchView'.

Table 85 describes class CIM_ConcreteComponentView (FCSwitchView to Fabric).

Table 85 - SMI Referenced Properties/Methods for CIM_ConcreteComponentView (FCSwitchView to Fabric)

Properties	Flags	Requirement	Description & Notes
GroupComponent		Mandatory	The Fabric the FCSwitchView instance belongs to.
PartComponent		Mandatory	The FCSwitchView instance.

8.6.7 CIM_ConcreteComponentView (FCTopologyView to Fabric)

Associates the Fabric AdminDomain to the CIM_FCTopologyView. NOTE: This is an association (CIM_ConcreteComponentView) to an association (CIM_FCTopologyView).

Created By: Static

Modified By: Static

Deleted By: Static

Requirement: Required if the array property CIM_ViewCapabilities.SupportedViews contains the string 'SNIA:TopologyView'.

Support Life Cycle Indications on View Classes

Table 86 describes class CIM_ConcreteComponentView (TopologyView to Fabric).

Table 86 - SMI Referenced Properties/Methods for FC_ConcreteComponentView (FCTopologyView to Fabric)

Properties	Flags	Requirement	Description & Notes
GroupComponent		Mandatory	The Fabric the FCTopologyView instance belongs to.
PartComponent		Mandatory	The FCTopologyView instance.

8.6.8 CIM_FCSwitchView

The CIM_FCSwitchView provides the properties to be able to discover all the switch properties for a Fibre Channel Switch and Ports without having to do associators from the ComputerSystem representing the Switch to FCPort, FCSwitchCapabilities, FCPortCapabilities, LogicalModule, Product, PhysicalPackage, SoftwareIdentity, AccessPoint, and Location.

Created By: Static

Modified By: Static

Deleted By: Static

Requirement: Required if the array property CIM_ViewCapabilities.SupportedViews contains the string 'SNIA:FCSwitchView'.

Table 87 describes class CIM_FCSwitchView.

Table 87 - SMI Referenced Properties/Methods for CIM_FCSwitchView

Properties	Flags	Requirement	Description & Notes
InstanceID		Mandatory	Opaque.
SwitchWWN	C	Mandatory	A Name_Identifier that is associated with a Fibre Channel switch.
DomainID		Mandatory	The Domain ID of the Switch as identified in the OtherIdentifyingInfo property of the underlying Switch ComputerSystem instance.
ElementName		Optional	The Symbolic Name of the Switch.
SwitchOperationalStatus		Mandatory	The operational status of the Switch.
SwitchEnabledState		Mandatory	EnabledState indicates the enabled and disabled states of the Fibre Channel Switch as defined in the EnabledState property of the underlying Switch ComputerSystem instance.
SwitchNPIVSupported		Optional	Flag indicating whether NPIV is support on the fibre channel switch as defined in the FCSwitchCapabilities.NPIVSupported property.
FCPortWWN	C	Mandatory	The FC Port Name Identifier (FC Port WWN).
FCPortElementName		Mandatory	The user friendly name of the FCPort.
FCPortType		Mandatory	The PortType of the FCPort.).
FCPortOperationalStatus		Mandatory	The operational status of the FCPort.
PortEnabledState		Mandatory	EnabledState indicates the enabled and disabled states of the Fibre Channel Port.
PortDiscriminator		Optional	An array property that identifies the context in which this FCPort is instantiated as defined in the underlying FCPort.

Support Life Cycle Indications on View Classes

Table 87 - SMI Referenced Properties/Methods for CIM_FCSwitchView

Properties	Flags	Requirement	Description & Notes
PortNumber		Mandatory	The port number labeled for an administrative purposes relative to the logical module. This is typically what is exposed through the devices element manager or CLI.
LogicalModulePortNumber		Optional	The port number labeled for an administrative purposes relative to the logical module.
DomainPortNumber		Optional	The port number used for domain id and physical port zone members.
ModuleNumber		Conditional	Conditional requirement: Required if the Blades profile is implemented. Logical modules are often named by the physical or logical slot that they occupy within the Switch.
PortNPIVSupported		Optional	Flag indicating whether NPIV is support on the fibre channel port as defined in the FCPortCapabilities for the FCPort.
MaxPortNPIVLogins		Optional	Maximum number of NPIV logins supported on the fibre channel port as defined in the FCPortCapabilities for the FCPort.
Vendor		Mandatory	The name of the Product's supplier of the Switch.
ProductName		Mandatory	Commonly used Product name.
VersionString		Mandatory	A string representing the complete software version of the Switch.
Model		Mandatory	The model of the switch as defined in the PhysicalPackage for the Switch.
SerialNumber		Optional	The SerialNumber of the switch as defined in the PhysicalPackage for the Switch.
PartNumber		Optional	The PartNumber of the switch as defined in the PhysicalPackage for the Switch.
OEM		Mandatory	The Vendor property in the Product associated to the switch for the OEM.
OEMProductName		Mandatory	The Name property in the Product associated to the switch for the OEM.
OEMIdentifyingNumber		Mandatory	The IdentifyingNumber property in the Product associated to the switch for the OEM.
AccessInfo		Conditional	Conditional requirement: Required if the Access Points profile is implemented. The management address as reported in the AccessInfo property of the CIM_RemoteServiceAccessPoint instance for the switch.
LocationName		Conditional	Conditional requirement: Required if the Location profile is implemented. A free-form string defining a label for the Location as defined by the Name property of the CIM_Location for the switch.
LocationPhysicalPosition		Optional	A free-form string indicating a street, building or other type of address for the switch's Location.

8.6.9 CIM_FCTopologyView

The CIM_FCTopologyView provides the properties to be able to build a topology for a Fibre Channel fabric without having to do associators from the ProtocolEndpoint to the FCPort to the FCNode or FCSwitch.

Created By: Static

Modified By: Static

Deleted By: Static

Requirement: Required if the array property CIM_ViewCapabilities.SupportedViews contains the string 'SNIA:TopologyView'.

Support Life Cycle Indications on View Classes

Table 88 describes class CIM_FCTopologyView.

Table 88 - SMI Referenced Properties/Methods for CIM_FCTopologyView

Properties	Flags	Requirement	Description & Notes
InstanceID		Mandatory	Opaque.
AntecedentFCPortWWN	C	Mandatory	The FC Port Name Identifier (FC Port WWN) of the FCPort the antecedent reference is associated to.
AntecedentElementWWN	C	Mandatory	The FC Switch Name Identifier (FC Switch WWN) or FC Node Name (FC Node WNN) the AntecedentFCPort is associated to.
AntecedentFCPortElement Name		Mandatory	The user friendly name of the FCPort the antecedent reference is associated to.
AntecedentFCPortType		Mandatory	The PortType of the FCPort the antecedent reference is associated to.).
DependentFCPortWWN	C	Mandatory	The FC Port Name Identifier (FC Port WWN) of the FCPort the Dependent reference is associated to.
DependentElementWWN	C	Mandatory	The FC Switch Name Identifier (FC Switch WWN) or FC Node Name (FC Node WNN) the DependentFCPort is associated to.
DependentFCPortElement Name		Mandatory	The user friendly name of the FCPort the dependent reference is associated to.
DependentFCPortType		Mandatory	The PortType of the FCPort the dependent reference is associated to.).
AntecedentFCPort		Mandatory	The reference to the antecedent FCPort that is communicating with the dependent FCPort.
AntecedentSystem		Mandatory	The reference to the system of the antecedent FCPort in the AntecedentFCPort SystemDevice association.
DependentFCPort		Mandatory	The reference to the dependent FCPort that is communicating with the antecedent FCPort.
DependentSystem		Mandatory	The reference to the system of the Dependent FCPort in the DependentFCPort SystemDevice association.

EXPERIMENTAL

EXPERIMENTAL

9 Virtual Fabrics

9.1 Synopsis

Profile Name: Virtual Fabrics (Component Profile)

Version: 1.5.0

Organization: SNIA

Central Class: AdminDomain

Scoping Class: an AdminDomain in a referencing autonomous profile

Related Profiles: Table 89 describes the supported profiles for Virtual Fabrics.

Table 89 - Supported Profiles for Virtual Fabrics

Profile Name	Organization	Version	Requirement	Description
SwitchPartitioning	SNIA	1.5.0	Mandatory	

9.2 Description

Technologies have recently been implemented for Fibre Channel SANs to logically separate the hardware into multiple fabrics yet keep them physically interconnected. The term for this technology defined by ANSI T11 is "Virtual Fabrics". ANSI T11 calls the underlying hardware "Core Switches". To be consistent with a more broader use model and DMTF schematics, this profile will call these the partitioning systems. ANSI T11 calls the switching construct that resides in the partitioning system, a virtual switch. Again for the broader use model and consistency with the DMTF, this system will be call the partitioned system. The Fabric Profile already provides the discovery of the "virtual fabrics" and the "partitioned switches". This profile allows for the discovery of the underlying partitioning system. The Switch Partitioning Profile provides the mechanism for configuring the partitioning system.

All Virtual Fabrics shall be associated to the same SAN for the same underlying "physical" topology. Also the Registered Profile associates to the SAN object to allow the client to arrive at the proper SAN object without traversing upwards from the fabric instance. In Figure 17: "RegisteredProfile, AdminDomain, and ComputerSystem Relationships", the relationship is shown. Note also that the partitioning ComputerSystems are associated with the SAN.

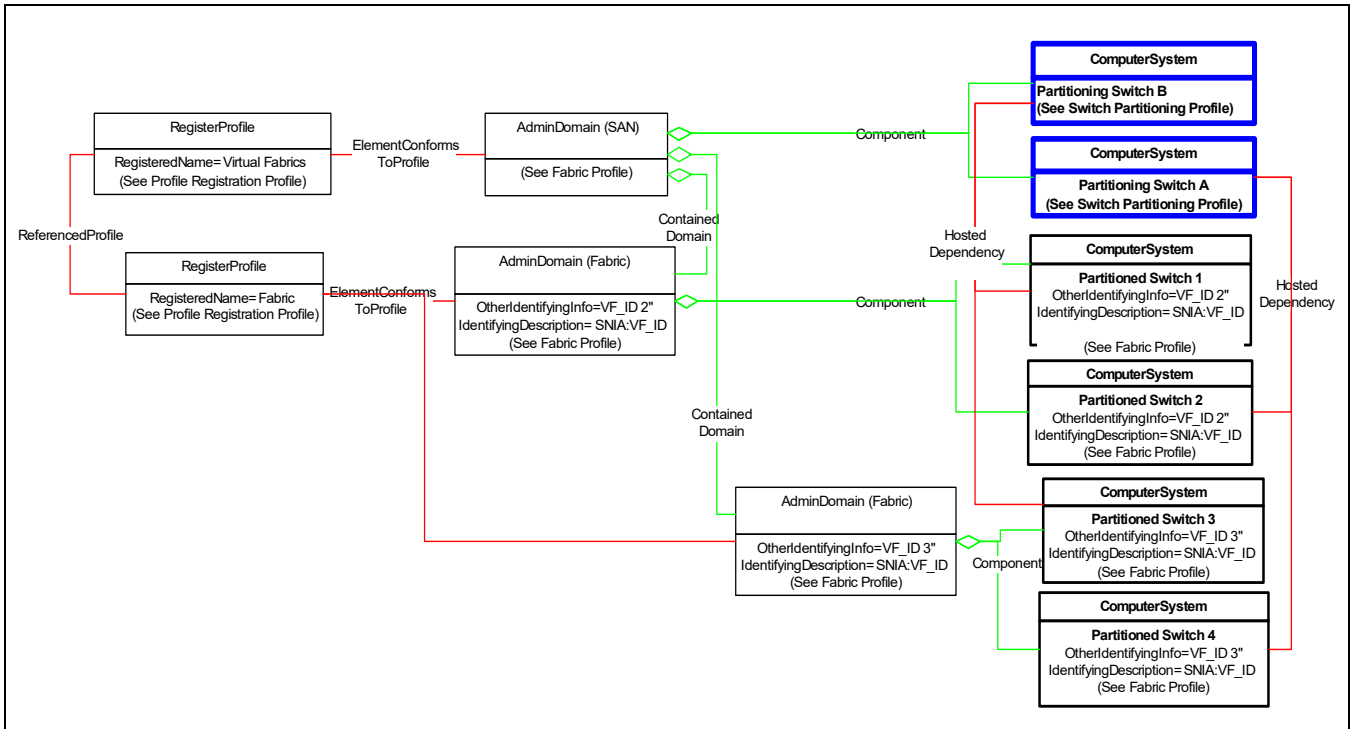

Figure 17 - RegisteredProfile, AdminDomain, and ComputerSystem Relationships

In Figure 17 the only thing added to the model beyond those elements in the Fabric Profile and the Switch Partitioning Profile are the ElementConformsToProfile association from the SAN AdminDomain (in the Fabric Profile) to the Virtual Fabrics RegisteredProfile and the Component association from the Partitioning ComputerSystem (from the Switch Partitioning Profile) to the same SAN AdminDomain. The Virtual Fabrics Profile is a component profile of the Fabric Profile and it requires implementation of the Switch Partitioning Profile.

In Figure 18: "Two Virtual Fabric and Two Partitioning Systems", the partitioning systems are shown presenting two "virtual fabric" with only one link (ActiveConnection) in each fabric. See section 4.2.3 for more information with regards to fabric topology using ActiveConnection. In this configuration each fabric, partitioned switch, and port are uniquely identified. Note that the new instances to support this profile are outlined in a bolded line.

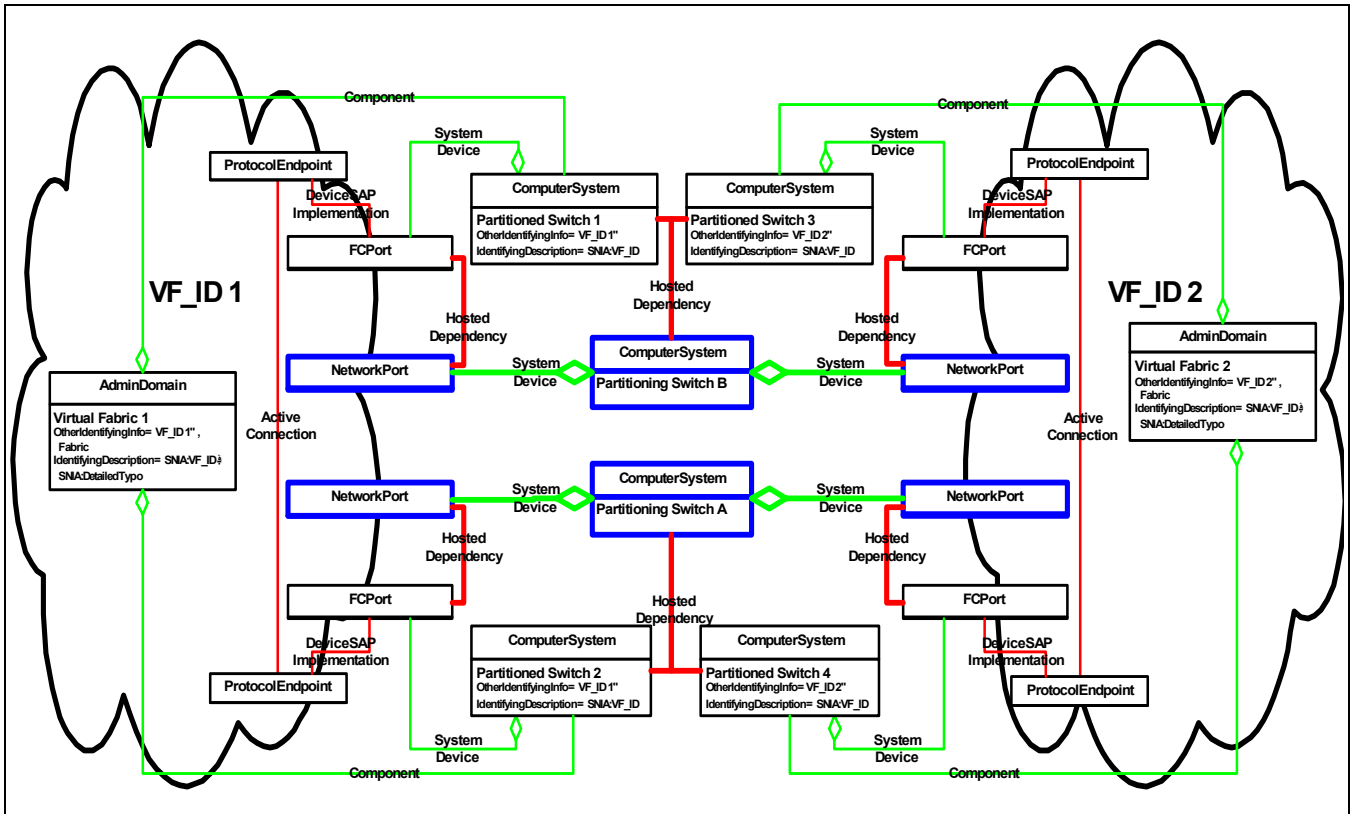

Figure 18 - Two Virtual Fabric and Two Partitioning Systems

In Figure 18: "Two Virtual Fabric and Two Partitioning Systems", a single partitioning system is creating two virtual fabrics and in Figure 19: "Two Virtual Fabrics and One Partitioning System", the system is partitioning the network port. When the NetworkPort is partitioned, each port is not guaranteed to be uniquely identified (though the key to the instance is) and the client needs to map it to the fabric it is participating in to maintain the ports identity.

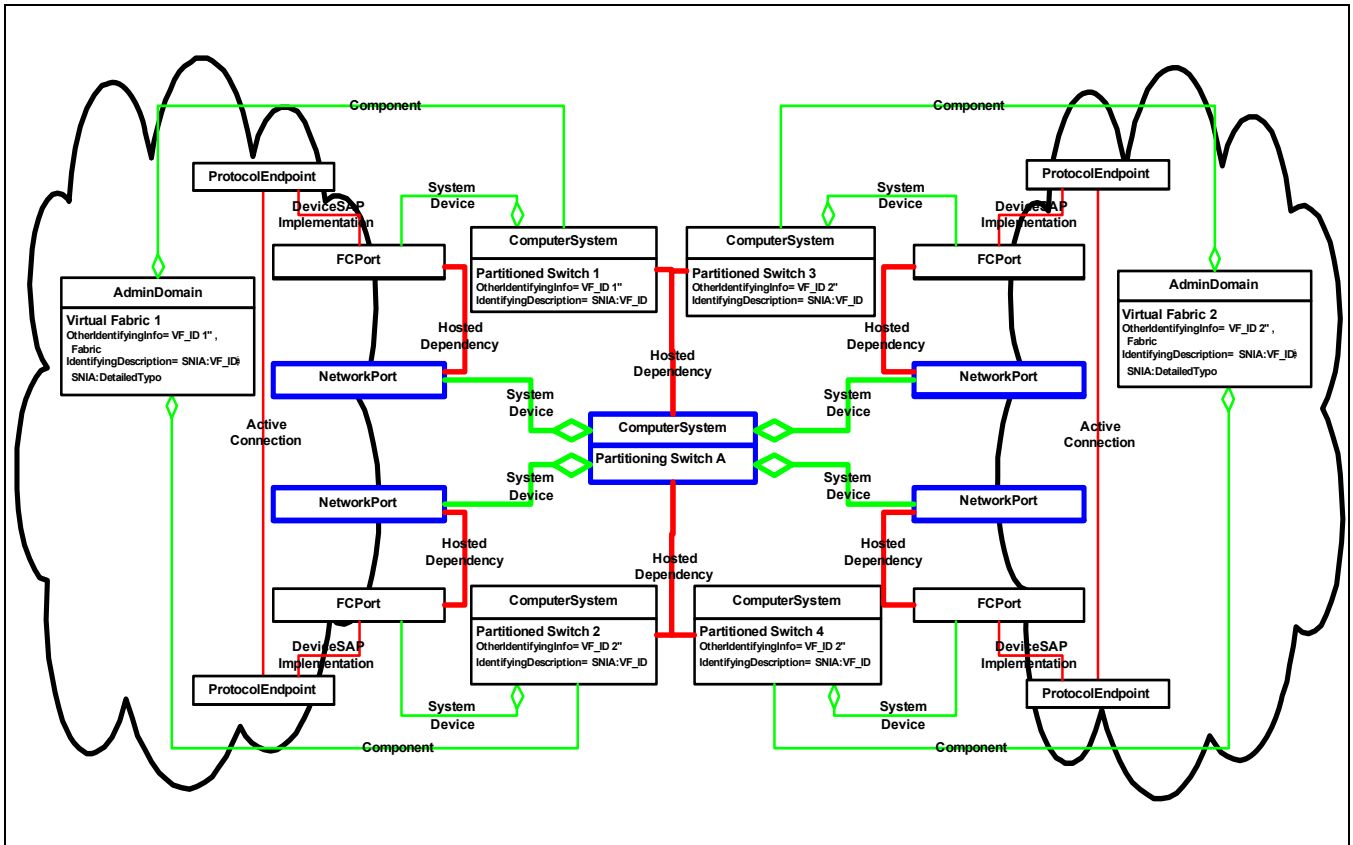

Figure 19 - Two Virtual Fabrics and One Partitioning System

In all cases you can have a one-to-one or many-to-one relationship between partitioned switches and the partitioning switch. The same is true between the partitioned FCPorts and the NetworkPorts.

To determine the end-to-end path of a fabric, the client follows the rules outlined in the Fabric Profile (see 4.2.3) with the exception that when entering a switch, if there exists a hosted dependency on the switch port, the partitioning system shall be traversed instead of the partitioned system. So in Figure 19: "Two Virtual Fabrics and One Partitioning System", when the client traverses across ActiveConnection to the ProtocolEndpoint to the FCPort and down the HostedDependency, it realizes that both ends of the link are actually in the same partitioned system.

9.3 Health and Fault Management Consideration

The possible Health and Fault information through LifeCycle indications are addressed in the Fabric Profile.

9.4 Cascading Considerations

Not defined in this document

9.5 Methods of the Profile

Not defined in this document

9.6 Use Cases

Not defined in this document.

9.7 CIM Elements

9.7.1 Overview

Table 90 describes the CIM elements for FabricVirtualFabrics.

Table 90 - CIM Elements for FabricVirtualFabrics

Element Name	Requirement	Description
9.7.2 CIM_Component (AdminDomain to Partitioning CS)	Mandatory	Associates the partitioning ComputerSystems representing the underlying physical switches to the AdminDomain representing the SAN.
9.7.3 CIM_ElementConformsToProfile (SAN AdminDomain to Virtual Fabrics RegisteredProfile)	Mandatory	Ties the SAN AdminDomain to the registered profile for Virtual Fabrics.

9.7.2 CIM_Component (AdminDomain to Partitioning CS)

Associates the partitioning ComputerSystems representing the underlying physical switches to the AdminDomain representing the SAN. This allows the client another means to determine which ComputerSystems are part of the Fabric versus those that are part of the underlying physical topology. ComputerSystems representing Fibre Channel switches are associated to the AdminDomain representing the fabric (see the Fabric Profile).

Created By: External

Modified By: Static

Deleted By: External

Requirement: Mandatory

Table 91 describes class CIM_Component (AdminDomain to Partitioning CS).

Table 91 - SMI Referenced Properties/Methods for CIM_Component (AdminDomain to Partitioning CS)

Properties	Flags	Requirement	Description & Notes
GroupComponent		Mandatory	The reference to the AdminDomain representing the SAN (OtherIdentifyingInfo contains 'SAN' with a corresponding 'SNIA:DetailedType' in IdentifyingDescriptions).
PartComponent		Mandatory	The reference to the partitioning ComputerSystem.

9.7.3 CIM_ElementConformsToProfile (SAN AdminDomain to Virtual Fabrics RegisteredProfile)

The CIM_ElementConformsToProfile ties SAN AdminDomain to the registered profile for Virtual Fabrics.

Created By: Static

Modified By: Static

Deleted By: Static

Requirement: Mandatory

Table 92 describes class CIM_ElementConformsToProfile (SAN AdminDomain to Virtual Fabrics RegisteredProfile).

Table 92 - SMI Referenced Properties/Methods for CIM_ElementConformsToProfile (SAN AdminDomain to Virtual Fabrics RegisteredProfile)

Properties	Flags	Requirement	Description & Notes
ManagedElement		Mandatory	A SAN AdminDomain (OtherIdentifyingInfo contains 'SAN' with a corresponding 'SNIA:DetailedType' in IdentifyingDescriptions) that represents the Virtual Fabric.
ConformantStandard		Mandatory	RegisteredProfile instance describing the Virtual Fabrics profile.

EXPERIMENTAL

STABLE
10 Switch Profile**10.1 Synopsis****Profile Name:** Switch (Autonomous Profile)**Version:** 1.8.0**Organization:** SNIA**Central Class:** ComputerSystem**Scoping Class:** ComputerSystem**Related Profiles:** Table 93 describes the supported profiles for Switch.**Table 93 - Supported Profiles for Switch**

Profile Name	Organization	Version	Requirement	Description
Blades	SNIA	1.8.0	Optional	
Access Points	SNIA	1.3.0	Optional	
Physical Package	SNIA	1.5.0	Mandatory	
Software	SNIA	1.4.0	Mandatory	
SwitchPartitioning	SNIA	1.5.0	Optional	Experimental.
Location	SNIA	1.4.0	Optional	
Power Supply	SNIA	1.0.1	Optional	Experimental.
Fan	SNIA	1.5.0	Optional	Experimental.
RecordLog	DMTF	1.0.1	Optional	
Launch In Context	DMTF	1.0.0	Optional	Experimental. See DSP1102, version 1.0.0
Indications	DMTF	1.2.2	Mandatory	See DSP1054, version 1.2.2

10.2 Description**10.2.1 Switch Profile**

The Switch Profile models logical and physical aspects of a Fibre Channel switch. The ComputerSystem class constitutes the center of the switch model (and is the top level object which the profile registration points to). An instance of a ComputerSystem is identified as a switch by the property Dedicated set to "switch".

This profile includes discovery components including ports, port statistics, product information, software, and chassis information. It also includes configuration of the switch including switch and port state change, port speed, switch name, symbolic names, and DomainID.

Both the Switch and Port have a capabilities class, FCSwitchCapabilities and FCPortCapabilities, respectively, defining which configuration options are supported by the switch. The capabilities define what components are configurable and any restrictions that apply. Except for state change, an associated settings class is defined for both the switch and port, FCSwitchSettings and FCPortSettings, which the client uses to request configuration changes to the Switch or Port, respectively. A setting does not

necessarily result in a change to the underlying Switch or Port. The client can determine whether the setting was applied by looking at the associated property in the Switch or Port class.

The model for configuration is made up of three components, capabilities, settings, and the ManagedElements, ComputerSystem and FCPort, as shown in Figure 20. The capabilities define what components are configurable and any restrictions that apply, the settings define what the client requests, and the ManagedElements expose the actual changes that were applied.

The ComputerSystem (Dedicated as Switch) and FCPort classes have the method RequestStateChange() for requesting that the state be changed and an associated property RequestedState on the classes which indicates the current state change that has been requested. The property EnabledState can be examined to determine whether the device has completed the state change.

If a switch is modular, for instance if the switch is comprised of multiple blades on a backplane, LogicalModule can optionally be used to model each sub-module, and as an aggregation point for the switch ports. This is described in the Blade Profile.

FCPort describes the logical aspects of the port link and the data layers. PhysicalConnector models the physical aspects of a port. An instance of the FCPortStatistics class is expected for each instance of the FCPort class. FCPortStatistics expose real time port health and traffic information.

If the instrumentation is embedded in a switch, it shall provide a switch profile implementation for the hosting switch, and it may proxy a switch profile implementation for other switches reported in the Fabric Profile.

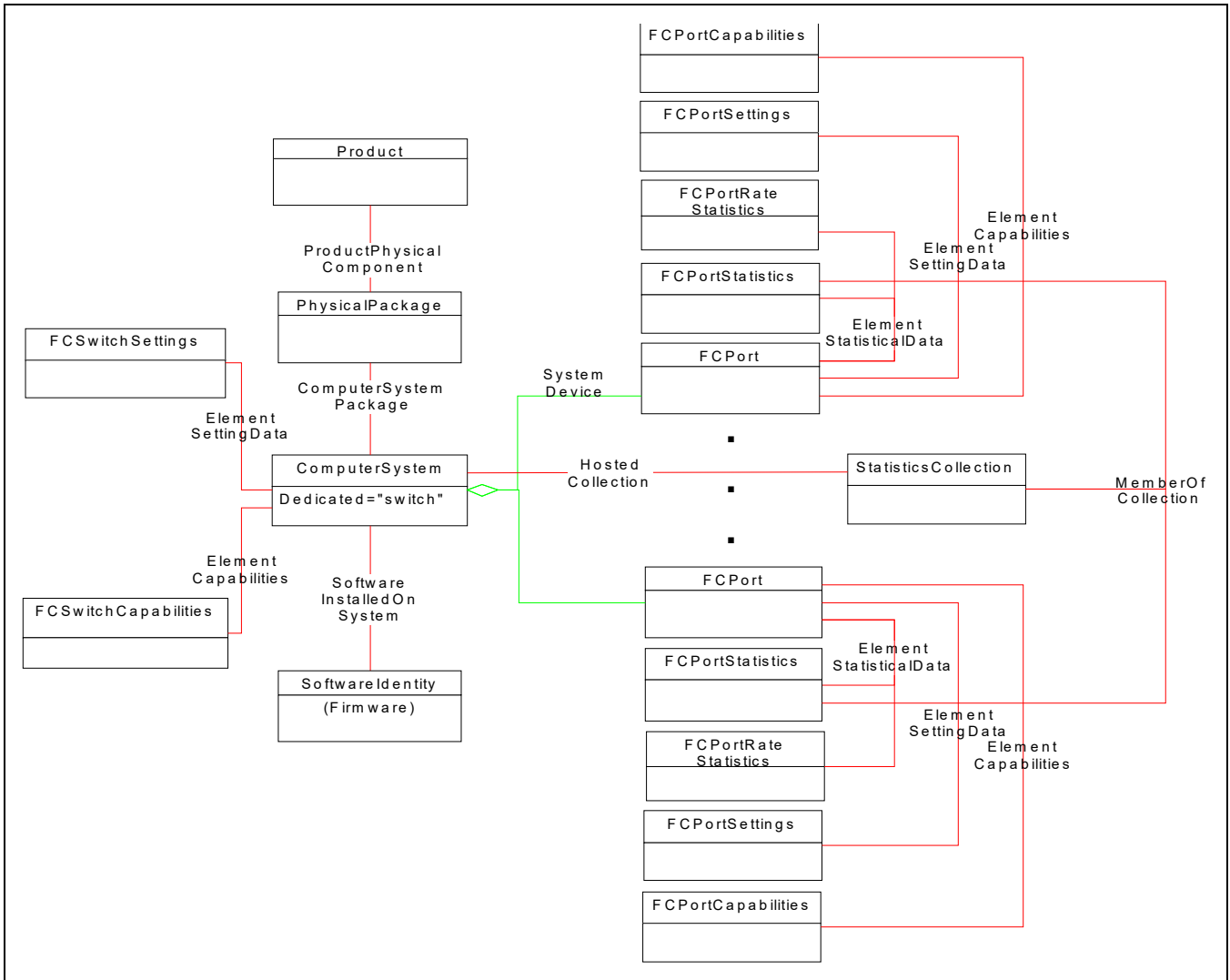

Figure 20 - Switch Instance Diagram

10.2.2 FC Port Settings and Capabilities

Capabilities describe the possible features that a ManagedElement supports. Settings are used to describe the requested configuration. The ManagedElement itself describes what settings have been applied and operating.

- For FC Port Type, there are settings that are not in the actual ManagedElement, FCPort.Types. These are settings that allow a subrange of possible port types. They are:
- A G_Port is a Switch Port that is capable of either operating as an E_Port or F_Port. A G_Port determines through Port Initialization whether it operates as an E_Port or as an F_Port.
- A GL_Port is a G_Port that is also capable of operating as an FL_Port.
- A Fx_Port is a switch port capable of operating as an F_Port or FL_Port.

The actual FCPort when operating shall run one of the port types as per FC-GS. In most cases a switch has a default setting to autonegotiate, which in most cases equates to GL or G being set in

FCPortSetting.RequestedType. It is required that this setting, FCPortSetting.RequestedType, be shown regardless of whether it was set administratively or is the default behavior of the switch. FCPortSetting.RequestedType represents a setting that the administrator can understand and clearly identify why a switch port ends up running a particular port type. If the switch does not support setting the port type, the RequestedTypesSupported array will be empty. It is valid to have a port type of "Unknown" until the link has been established. In 10.7.15 CIM_FCPortSettings, Figure 110 is showing the relationship of particular port types and how the capabilities relate to the setting for these port types.

The same concept applies for FCPort settings for speed except there is a separate property indicating auto negotiate, FCPortSettings.AutoSenseSpeed (LogicalPortSettings.AutoSenseSpeed). Note that this setting may have been previously set through some other administrative interface (e.g., CLI), but should still be reported in FCPortSettings.RequestedSpeed. If FCPortSetting.AutoSenseSpeed is true, then the value of FCPortSettings.RequestedSpeed is ignored and the speed will be negotiated by the hardware. If it is disabled, the port will operate at the speed configured in FCPortSettings.RequestedSpeed.

FCPortSettings.RequestedSpeed allows the port speed to be administratively set (WRITE qualifier). It also indicates to the client that the port has been administratively set (now or at a previous time). This property can only be set administratively if FCPortCapabilities.RequestedSpeedsSupported[] is not empty, and may only be set to one of the values in FCPortCapabilities.RequestedSpeedsSupported[].

FCPortCapabilities.RequestedSpeedsSupported indicates whether the device allows the speed to be administratively set. For instance, a 4Gb port may allow 1, 2, and 4 Gb. FCPort.Speed (LogicalPort.Speed) represents the actual speed the port is running and a speed of zero represents that the link has not been established.

10.2.3 Trunking

Trunking describes from a switch perspective which ports are working together passing frames using the class RedundancySet. The RedundancySet has a property TypeOfSet which is used to identify what type of redundancy or trunking is occurring among the switch ports associated to the RedundancySet using MemberOfCollection. Figure 21 shows a Trunking instance.

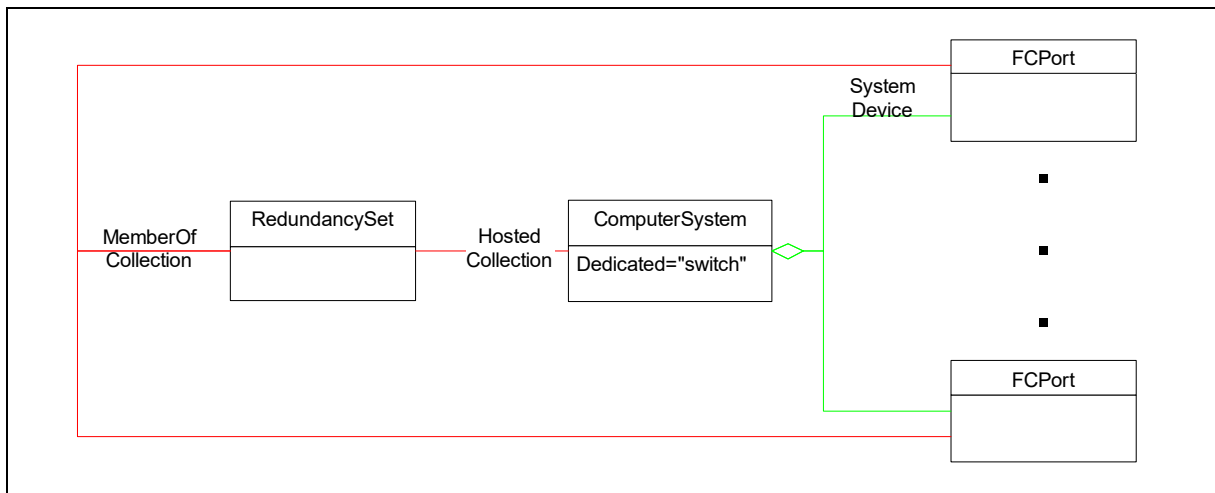

Figure 21 - Trunking Instance Diagram

EXPERIMENTAL
10.2.4 DetailedPortState, PortAvailability, OperationalStatus, and EnabledState

Table 2 - "Port OperationalStatus" is the starting point for the status of FCPort. It is a mandatory property of 4 Fabric Profile. EnabledState is also mandatory in Clause 4: Fabric Profile, but only as the value Not Applicable. EnabledState has additional values when 10 Switch Profile is implemented. Those values are shown in Table 94 which also shows how EnabledState relates to OperationalStatus. Table 94 and Table 95 contain specifics about the expected values of the properties for FCPorts DetailedPortState and PortAvailability and their relationship to OperationalStatus and EnabledState.

In Table 94 are specifics about the expected values of the properties for FCPorts DetailedPortState and its relationship to OperationalStatus, EnabledState and PortAvailability.

Table 94 - DetailedPortState for FCPort

DetailedPortState	OperationalStatus	EnabledState	PortAvailability
Transceiver Validation	Starting	Starting	Available
Locking To Reference Signal	Starting	Starting	Available
Synchronized	OK	Enabled	Available
Invalid Transceiver	Error	Enabled, but offline	Available
No Light (1)	OK	Enabled, but offline	Available
Cannot Synchronize	Error	Disabled	Available
Laser Fault	Error	Disabled	Available
Port Fault	Error	Disabled	Available
Diagnostic Fault	Error	Disabled	Available
Unknown	Unknown	Disabled	Any value in Table 95

(1) When there is no light, this only indicates that the transceiver is not receiving light and the transceiver is operational. Typically this case occurs when there is no cable attached, but can also be caused by a broken/defective cable.

In Table 95 are specifics about the expected values of the properties for PortAvailability and its relationship to OperationalStatus, EnabledState and DetailedPortState.

Table 95 - PortAvailability for FCPort

PortAvailability	OperationalStatus	EnabledState	DetailedPortState
Available	Any value in Table 2, "Port OperationalStatus,"	Any value in Table 94 except Unknown	Any value in Table 94
Not Installed	Stopped	Disabled	Unknown
No Transceiver	Stopped	Disabled	Unknown
Not Licensed	Stopped	Disabled	Unknown

EXPERIMENTAL

EXPERIMENTAL

10.2.5 Conditional Classes and Properties

Table 96 contains classes that are conditional on the implementation of other profiles:

- CIM_ComputerSystem (Partitioned Switch) is conditional on the implementation of the Switch Partitioning Profile
- CIM_FCPort (Partitioned Switch FCPort) is conditional on the implementation of the Switch Partitioning Profile

In addition, some properties of the Switch classes are conditional on implementation of other profiles:

- The ElementName, OtherIdentifyingInfo, IdentifyingDescriptions and EnabledState of CIM_ComputerSystem (Switch) are required if the Fabric Profile is implemented.
- EnabledState of CIM_FCPort (Switch FCPort) is required if the Fabric Profile is implemented
- PortDiscriminator of CIM_FCPort (Switch FCPort) is required if the Switch Partitioning Profile is implemented.

EXPERIMENTAL

10.3 Health and Fault Management

The following classes report possible Health and Fault information through LifeCycle indications:

- ComputerSystem
- FCPort

These LifeCycle indications are more fully described in *Storage Management Technical Specification, Part 3 Common Profiles, 1.8.0 Rev 4 Table 224*.

Also in Table 96, "CIM Elements for Switch" is a list of AlertIndications which may also be indicators for Health and Fault Management.

10.4 Cascading Considerations

Not defined in this document

10.5 Methods of this Profile

Not defined in this document

10.6 Use Cases

Not defined in this document.

10.7 CIM Elements

10.7.1 Overview

Table 96 describes the CIM elements for Switch.

Table 96 - CIM Elements for Switch

Element Name	Requirement	Description
10.7.2 CIM_ComputerSystem (Partitioned Switch)	Conditional	Conditional requirement: Support for the Switch Partitioning profile. Represents the Partitioned Switch.
10.7.3 CIM_ComputerSystem (Switch)	Mandatory	Represents the Switch Associated to RegisteredProfile.
10.7.4 CIM_ComputerSystemPackage	Mandatory	Associates PhysicalPackage to the ComputerSystem (Switch).
10.7.5 CIM_ElementCapabilities (FCPort to FCPortCapabilities)	Mandatory	Associates FCPort to the FCPortCapabilities.
10.7.6 CIM_ElementCapabilities (System to FCSwitchCapabilities)	Mandatory	Associates FCSwitchCapabilities to the ComputerSystem (Switch).
10.7.7 CIM_ElementSettingData (FCPortSettings to FCPort)	Optional	Associates FCPortSettings to FCPort.
10.7.8 CIM_ElementSettingData (FCSwitchSettings to ComputerSystem)	Mandatory	Associates FCSwitchSettings to ComputerSystem (Switch).
10.7.9 CIM_ElementStatisticalData (FCPortRateStatistics to FCPort)	Optional	Associates FCPortRateStatistics to the FCPort.
10.7.10 CIM_ElementStatisticalData (FCPortStatistics to FCPort)	Mandatory	Associates FCPortStatistics to the FCPort.
10.7.11 CIM_FCPort (Partitioned Switch FCPort)	Conditional	Conditional requirement: Support for the Switch Partitioning profile. Fibre Channel Switch Port for a Virtual Switch.
10.7.12 CIM_FCPort (Switch FCPort)	Mandatory	Fibre Channel Switch Port.
10.7.13 CIM_FCPortCapabilities	Mandatory	Switch Port Capabilities.
10.7.14 CIM_FCPortRateStatistics	Optional	Fibre Channel Switch Port Rate Statistics.
10.7.15 CIM_FCPortSettings	Optional	Switch Port Settings.
10.7.16 CIM_FCPortStatistics	Mandatory	Fibre Channel Switch Port Statistics.
10.7.17 CIM_FCSwitchCapabilities	Mandatory	Fibre Channel Switch Capabilities.
10.7.18 CIM_FCSwitchSettings	Mandatory	Fibre Channel Switch Settings.
10.7.19 CIM_HostedCollection (Redundancy Set)	Optional	Associates the redundancy set of FCPorts to the ComputerSystem representing the switch.
10.7.20 CIM_HostedCollection (Statistics Collection)	Mandatory	Associates the Statistics Collection to the ComputerSystem representing the switch.
10.7.21 CIM_MemberOfCollection (FCPort to RedundancySet)	Optional	Associates the FCPort to the RedundancySet.
10.7.22 CIM_MemberOfCollection (NetworkPortStatistics to StatisticalCollection)	Mandatory	Associates the NetworkPortStatistics to the StatisticsCollection.
10.7.23 CIM_ProtocolEndpoint	Optional	The endpoint of a link (ActiveConnection).

Table 96 - CIM Elements for Switch

Element Name	Requirement	Description
10.7.24 CIM_RedundancySet	Optional	The class RedundancySet along with the association MemberOfCollection in this profile is used to show port aggregation for Fibre Channel trunking.
10.7.25 CIM_StatisticsCollection	Mandatory	Collection to aggregate the FCPortStatistics for each switch.
10.7.26 CIM_SystemDevice	Mandatory	Associates FCPort to the ComputerSystem (Switch).
SELECT * FROM CIM_InstCreation WHERE SourceInstance ISA CIM_ComputerSystem	Mandatory	New Switch Instance.
SELECT * FROM CIM_InstDeletion WHERE SourceInstance ISA CIM_ComputerSystem	Mandatory	Deletion of Switch Instance.
SELECT * FROM CIM_InstModification WHERE SourceInstance ISA CIM_ComputerSystem AND SourceInstance.CIM_ComputerSystem::OperationalStatus <> PreviousInstance.CIM_ComputerSystem::OperationalStatus	Mandatory	CQL -Modification of OperationalStatus in Switch Instance.
SELECT * FROM CIM_InstModification WHERE SourceInstance ISA CIM_FCPort AND SourceInstance.CIM_FCPort::OperationalStatus <> PreviousInstance.CIM_FCPort::OperationalStatus	Mandatory	CQL -Modification of OperationalStatus in FC Port Instance.

10.7.2 CIM_ComputerSystem (Partitioned Switch)

Represents the Partitioned Switch. A Partitioned Switch shall contain 'Virtual Switch' in one of its entries in OtherIdentifyingInfo with a corresponding value of 'SNIA:DetailedType' in the IdentifyingDescriptions array property.

Created By: Static

Modified By: Static

Deleted By: Static

Requirement: Support for the Switch Partitioning profile.

Table 97 describes class CIM_ComputerSystem (Partitioned Switch).

Table 97 - SMI Referenced Properties/Methods for CIM_ComputerSystem (Partitioned Switch)

Properties	Flags	Requirement	Description & Notes
CreationClassName		Mandatory	See the CreationClassName definition in section <i>Storage Management Technical Specification, Part 6 Fabric, 1.8.0 Rev 4 10.7.3</i> CIM_ComputerSystem (Switch).
Name	D	Mandatory	See the Name definition in section <i>Storage Management Technical Specification, Part 6 Fabric, 1.8.0 Rev 4 10.7.3</i> CIM_ComputerSystem (Switch).
ElementName		Conditional	Conditional requirement: Support for the Fabric profile. See the ElementName definition in section <i>Storage Management Technical Specification, Part 6 Fabric, 1.8.0 Rev 4 4.7.10</i> CIM_ComputerSystem (Switch) User friendly name. Can be set if FCSwitchCapabilities.ElementNameEditSupported for the switch is True.

Table 97 - SMI Referenced Properties/Methods for CIM_ComputerSystem (Partitioned Switch)

Properties	Flags	Requirement	Description & Notes
NameFormat		Mandatory	See the NameFormat definition in section <i>Storage Management Technical Specification, Part 6 Fabric, 1.8.0 Rev 4 10.7.3</i> CIM_ComputerSystem (Switch).
OtherIdentifyingInfo	C	Mandatory	DomainID stored in decimal format, with a value between 0 and 255. Another value corresponding to 'SNIA:DetailedType' shall contain 'Virtual Switch'. Other entries in OtherIdentifyingInfo may also exist.
OperationalStatus		Mandatory	See <i>Storage Management Technical Specification, Part 6 Fabric, 1.8.0 Rev 4 Table 3 - OperationalStatus</i> for ComputerSystem.
IdentifyingDescriptions		Mandatory	'DomainID' is placed into the entry that corresponds to the DomainID in OtherIdentifyingInfo and 'SNIA:DetailedType' is placed in the entry corresponding to 'Virtual Switch' in OtherIdentifyingInfo.
Dedicated		Mandatory	See the Dedicated definition in section <i>Storage Management Technical Specification, Part 6 Fabric, 1.8.0 Rev 4 10.7.3</i> CIM_ComputerSystem (Switch).
EnabledState		Conditional	Conditional requirement: Support for the Fabric profile. See the EnabledState definition in section <i>Storage Management Technical Specification, Part 6 Fabric, 1.8.0 Rev 4 4.7.10</i> CIM_ComputerSystem (Switch).
RequestedState		Mandatory	See the RequestedState definition in section <i>Storage Management Technical Specification, Part 6 Fabric, 1.8.0 Rev 4 10.7.3</i> CIM_ComputerSystem (Switch).
EnabledDefault		Optional	See the EnabledDefault definition in section <i>Storage Management Technical Specification, Part 6 Fabric, 1.8.0 Rev 4 10.7.3</i> CIM_ComputerSystem (Switch).
RequestStateChange()		Conditional	Conditional requirement: Support for a non-null value in FCSwitchCapabilities.RequestedStatesSupported.

10.7.3 CIM_ComputerSystem (Switch)

Represents the Switch.

Created By: Static

Modified By: Static

Deleted By: Static

Requirement: Mandatory

Shall be associated to RegisteredProfile using ElementConformsToProfile association. The RegisteredProfile instance shall have RegisteredName set to 'Switch', RegisteredOrganization set to 'SNIA', and RegisteredVersion set to '1.8.0'.

Table 98 describes class CIM_ComputerSystem (Switch).

Table 98 - SMI Referenced Properties/Methods for CIM_ComputerSystem (Switch)

Properties	Flags	Requirement	Description & Notes
CreationClassName		Mandatory	Name of Class.
Name	D	Mandatory	Switch Name (WWN).

Table 98 - SMI Referenced Properties/Methods for CIM_ComputerSystem (Switch)

Properties	Flags	Requirement	Description & Notes
ElementName		Conditional	Conditional requirement: Support for the Fabric profile. See the ElementName definition in section <i>Storage Management Technical Specification, Part 6 Fabric, 1.8.0 Rev 4 4.7.10</i> CIM_ComputerSystem (Switch) User friendly name. Can be set if FCSwitchCapabilities.ElementNameEditSupported for the switch is True.
NameFormat		Mandatory	Shall be 'WWN'.
OtherIdentifyingInfo	C	Conditional	Conditional requirement: Support for the Fabric profile. See the OtherIdentifyingInfo definition in section <i>Storage Management Technical Specification, Part 6 Fabric, 1.8.0 Rev 4 4.7.10</i> CIM_ComputerSystem (Switch) DomainID stored in decimal format, with a value between 0 and 255. In addition, if the Fabric profile is implemented, then another value corresponding to 'SNIA:DetailedType' shall contain 'Front Domain', 'Translate Domain', 'Virtual Switch', 'Backbone' or 'None'.
OperationalStatus		Mandatory	See <i>Storage Management Technical Specification, Part 6 Fabric, 1.8.0 Rev 4 Table 3 - OperationalStatus</i> for ComputerSystem.
IdentifyingDescriptions		Conditional	Conditional requirement: Support for the Fabric profile. See the IdentifyingDescriptions definition in section <i>Storage Management Technical Specification, Part 6 Fabric, 1.8.0 Rev 4 4.7.10</i> CIM_ComputerSystem (Switch) 'DomainID' is placed into corresponding index of OtherIdentifyingInfo. In addition, if the Fabric profile is implemented, then one of the other indices shall contain the value 'SNIA:DetailedType' and in the corresponding index for OtherIdentifyingInfo a value of 'Front Domain' for an Inter-Fabric Routing (IFR) Front Domain, 'Translate Domain' for an Inter-Fabric Routing (IFR) Translate Domain, 'Virtual Switch' for a Partitioned Switch, 'Backbone' for a Backbone Switch, or 'None' when the other values don't apply.
Dedicated		Mandatory	'Switch'.
EnabledState		Conditional	Conditional requirement: Support for the Fabric profile. See the EnabledState definition in section <i>Storage Management Technical Specification, Part 6 Fabric, 1.8.0 Rev 4 4.7.10</i> CIM_ComputerSystem (Switch)
RequestedState		Mandatory	The Switch state requested via RequestStateChange(). Shall be of the range specified in FCSwitchCapabilities.RequestedStatesSupported if a state change has been requested. Otherwise shall be 'Not Applicable'.
EnabledDefault		Optional	Default startup for the Switch.
RequestStateChange()		Conditional	Conditional requirement: Support for a non-null value in FCSwitchCapabilities.RequestedStatesSupported.

10.7.4 CIM_ComputerSystemPackage

Associates PhysicalPackage to the ComputerSystem (Switch).

Created By: Static

Modified By: Static

Deleted By: Static

Requirement: Mandatory

Table 99 describes class CIM_ComputerSystemPackage.

Table 99 - SMI Referenced Properties/Methods for CIM_ComputerSystemPackage

Properties	Flags	Requirement	Description & Notes
Antecedent		Mandatory	The reference to the PhysicalPackage.
Dependent		Mandatory	The reference to the Switch ComputerSystem.

10.7.5 CIM_ElementCapabilities (FCPort to FCPortCapabilities)

Created By: Static

Modified By: Static

Deleted By: Static

Requirement: Mandatory

Table 100 describes class CIM_ElementCapabilities (FCPort to FCPortCapabilities).

Table 100 - SMI Referenced Properties/Methods for CIM_ElementCapabilities (FCPort to FCPortCapabilities)

Properties	Flags	Requirement	Description & Notes
ManagedElement		Mandatory	The reference to the switch FCPort.
Capabilities		Mandatory	The reference to the FCPortCapabilities.

10.7.6 CIM_ElementCapabilities (System to FCSwitchCapabilities)

Created By: Static

Modified By: Static

Deleted By: Static

Requirement: Mandatory

Table 101 describes class CIM_ElementCapabilities (System to FCSwitchCapabilities).

Table 101 - SMI Referenced Properties/Methods for CIM_ElementCapabilities (System to FCSwitchCapabilities)

Properties	Flags	Requirement	Description & Notes
ManagedElement		Mandatory	The reference to the Switch ComputerSystem.
Capabilities		Mandatory	The reference to the FCSwitchCapabilities.

10.7.7 CIM_ElementSettingData (FCPortSettings to FCPort)

Created By: Static

Modified By: Static

Deleted By: Static

Requirement: Optional

Table 102 describes class CIM_ElementSettingData (FCPortSettings to FCPort).

Table 102 - SMI Referenced Properties/Methods for CIM_ElementSettingData (FCPortSettings to FCPort)

Properties	Flags	Requirement	Description & Notes
ManagedElement		Mandatory	The reference to the switch FCPort.
SettingData		Mandatory	The reference to the FCPortSettings.

10.7.8 CIM_ElementSettingData (FCSwitchSettings to ComputerSystem)

Associates FCSwitchSettings to ComputerSystem (Switch).

Created By: Static
 Modified By: Static
 Deleted By: Static
 Requirement: Mandatory

Table 103 describes class CIM_ElementSettingData (FCSwitchSettings to ComputerSystem).

Table 103 - SMI Referenced Properties/Methods for CIM_ElementSettingData (FCSwitchSettings to ComputerSystem)

Properties	Flags	Requirement	Description & Notes
SettingData		Mandatory	The reference to the FCSwitchSettings.
ManagedElement		Mandatory	The reference to the switch ComputerSystem.

10.7.9 CIM_ElementStatisticalData (FCPortRateStatistics to FCPort)

Created By: Static
 Modified By: Static
 Deleted By: Static
 Requirement: Optional

Table 104 describes class CIM_ElementStatisticalData (FCPortRateStatistics to FCPort).

Table 104 - SMI Referenced Properties/Methods for CIM_ElementStatisticalData (FCPortRateStatistics to FCPort)

Properties	Flags	Requirement	Description & Notes
Stats		Mandatory	The reference to the FCPortRateStatistics.
ManagedElement		Mandatory	The reference to the switch FCPort.

10.7.10 CIM_ElementStatisticalData (FCPortStatistics to FCPort)

Created By: Static
 Modified By: Static
 Deleted By: Static
 Requirement: Mandatory

Table 105 describes class CIM_ElementStatisticalData (FCPortStatistics to FCPort).

Table 105 - SMI Referenced Properties/Methods for CIM_ElementStatisticalData (FCPortStatistics to FCPort)

Properties	Flags	Requirement	Description & Notes
Stats		Mandatory	The reference to the FCPortStatistics.
ManagedElement		Mandatory	The reference to the switch FCPort.

10.7.11 CIM_FCPort (Partitioned Switch FCPort)

The Fibre Channel Switch Port for a Virtual Switch.

Created By: Static

Modified By: Extrinsic: RequestStateChange

Deleted By: Static

Requirement: Support for the Switch Partitioning profile.

Table 106 describes class CIM_FCPort (Partitioned Switch FCPort).

Table 106 - SMI Referenced Properties/Methods for CIM_FCPort (Partitioned Switch FCPort)

Properties	Flags	Requirement	Description & Notes
SystemCreationClassName		Mandatory	See the SystemCreationClassName definition in section 10.7.12 CIM_FCPort (Switch FCPort).
SystemName		Mandatory	See the SystemName definition in section 10.7.12 CIM_FCPort (Switch FCPort).
CreationClassName		Mandatory	See the CreationClassName definition in section 10.7.12 CIM_FCPort (Switch FCPort).
DeviceID		Mandatory	See the DeviceID definition in section 10.7.12 CIM_FCPort (Switch FCPort).
ElementName		Mandatory	See the ElementName definition in section 10.7.12 CIM_FCPort (Switch FCPort).
OperationalStatus		Mandatory	See <i>Storage Management Technical Specification, Part 6 Fabric, 1.8.0 Rev 4</i> Table 2 - Port OperationalStatus.
EnabledState		Conditional	Conditional requirement: Support for the Fabric profile.
DetailedPortState		Mandatory	Experimental. See Table 94 - DetailedPortState for FCPort.
PortAvailability		Optional	Experimental. See Table 95 - PortAvailability for FCPort.
RequestedState		Mandatory	See the RequestedState definition in section 10.7.12 CIM_FCPort (Switch FCPort).
EnabledDefault		Mandatory	See the EnabledDefault definition in section 10.7.12 CIM_FCPort (Switch FCPort).
Speed		Mandatory	See the Speed definition in section 10.7.12 CIM_FCPort (Switch FCPort).
MaxSpeed		Mandatory	See the MaxSpeed definition in section 10.7.12 CIM_FCPort (Switch FCPort).
PortType		Mandatory	See the PortType definition in section 10.7.12 CIM_FCPort (Switch FCPort).

Table 106 - SMI Referenced Properties/Methods for CIM_FCPort (Partitioned Switch FCPort)

Properties	Flags	Requirement	Description & Notes
PortNumber		Mandatory	See the PortNumber definition in section 10.7.12 CIM_FCPort (Switch FCPort).
PermanentAddress		Mandatory	See the PermanentAddress definition in section 10.7.12 CIM_FCPort (Switch FCPort).
LinkTechnology		Mandatory	See the LinkTechnology definition in section 10.7.12 CIM_FCPort (Switch FCPort).
PortDiscriminator		Conditional	Experimental. Conditional requirement: Support for the Switch Partitioning profile. This array property identifies the context in which this FCPort is instantiated. For Partitioned Switch FCPorts, the values may be '3' (VF), '6' (IFR (Virtual)) or '7' (NPIV).
DomainPortNumber		Optional	Experimental. The port number used for domain id and physical port zone members.
LogicalModulePortNumber		Optional	Experimental. The port number labeled for an administrative purposes relative to the logical module.
RequestStateChange()		Conditional	Conditional requirement: Support for a non-null value in FCPortCapabilities.RequestedStatesSupported. See the RequestedStateChange definition in section 10.7.12 CIM_FCPort (Switch FCPort).

10.7.12 CIM_FCPort (Switch FCPort)

The Fibre Channel Switch Port.

Created By: Static

Modified By: Extrinsic: RequestStateChange

Deleted By: Static

Requirement: Mandatory

Table 107 describes class CIM_FCPort (Switch FCPort).

Table 107 - SMI Referenced Properties/Methods for CIM_FCPort (Switch FCPort)

Properties	Flags	Requirement	Description & Notes
SystemCreationClassName		Mandatory	The scoping System's CreationClassName.
SystemName		Mandatory	The scoping System's Name.
CreationClassName		Mandatory	The Class Name.
DeviceID		Mandatory	Opaque.
ElementName		Mandatory	User friendly name. Can be set if FCPortCapabilities.ElementNameEditSupported is True.
OperationalStatus		Mandatory	See Storage Management Technical Specification, Part 6: Fabric, version 1.8.0, Table 2 - Port OperationalStatus.
EnabledState		Conditional	Conditional requirement: Support for the Fabric profile.
DetailedPortState		Mandatory	Experimental. See Table 94 - DetailedPortState for FCPort.
PortAvailability		Optional	Experimental. See Table 95 - PortAvailability for FCPort.

Table 107 - SMI Referenced Properties/Methods for CIM_FCPort (Switch FCPort)

Properties	Flags	Requirement	Description & Notes
RequestedState		Mandatory	The port state requested via RequestStateChange(). Shall be of the range specified in FCPortCapabilities.RequestedStatesSupported if a state change has been requested. Otherwise shall be 'Not Applicable'.
EnabledDefault		Mandatory	Default startup for the port. Used in conjunction with RequestedState can allow for persistent disabling of a port.
Speed		Mandatory	Experimental. Speed of zero represents a link not established. 1 GFC is 1062500000 bps 2 GFC is 2125000000 bps 4 GFC is 4250000000 bps 8 GFC= 8500000000 bps 10 GFC single channel variants are 10518750000 bps 10 GFC four channel variants are 12750000000 bps 16 GFC = 14025000000 bps 32 GFC = 28500000000 bps 128 GFC = 114000000000 bps This is the raw bit rate.
MaxSpeed		Mandatory	The max speed of the Port in Bits per Second using the same algorithm as Speed.
PortType		Mandatory	FC-GS Port.Type The specific mode currently enabled for the Port. The values: 'N' = Node Port 'NL' = Node Port supporting FC arbitrated loop 'E' = Expansion Port connecting fabric elements (for example, FC switches) 'F' = Fabric (element) Port 'FL' = Fabric (element) Port supporting FC arbitrated loop 'B' = Bridge Port. PortTypes are defined in the ANSI INCITS FC-GS standards. Can be set using FCPortSettings.RequestedType.
PortNumber		Mandatory	NetworkPorts are often numbered relative to either a logical modules or a network element.
PermanentAddress		Mandatory	Fibre Channel Port WWN.
LinkTechnology		Mandatory	'FC'.
PortDiscriminator		Optional	Experimental. This array property identifies the context in which this FCPort is instantiated. For this version of the standard, the values may be '0' (Unknown), '2' (Not applicable), '3' (VF), '4' (FCIP), '5' (IFR), '6' (IFR (Virtual)), '7' (NPiV), '8' (Internal) or '9' (Chassis).
DomainPortNumber		Optional	Experimental. The port number used for domain id and physical port zone members.

Table 107 - SMI Referenced Properties/Methods for CIM_FCPort (Switch FCPort)

Properties	Flags	Requirement	Description & Notes
LogicalModulePortNumber		Optional	Experimental. The port number labeled for an administrative purposes relative to the logical module.
RequestStateChange()		Conditional	Conditional requirement: Support for a non-null value in FCPortCapabilities.RequestedStatesSupported. Method to change the port state. FCPortCapabilities.RequestedStatesSupported indicates what states can be set.

10.7.13 CIM_FCPortCapabilities

Created By: Static

Modified By: Static

Deleted By: Static

Requirement: Mandatory

Table 108 describes class CIM_FCPortCapabilities.

Table 108 - SMI Referenced Properties/Methods for CIM_FCPortCapabilities

Properties	Flags	Requirement	Description & Notes
InstanceID		Mandatory	Opaque.
ElementName		Mandatory	Shall be 'FC Port Capabilities'.
ElementNameEditSupported		Mandatory	Indicates whether FCPort.ElementName is settable.
MaxElementNameLen		Mandatory	Indicates the maximum string length of FCPort.ElementName.
RequestedStatesSupported	N	Mandatory	Indicates the supported states for calling FCPort.RequestStateChange(). If this property is NULL it means RequestedStateChange is not supported. Otherwise the values may be '2' (Enabled), '3' (Disabled), '4' (Shutdown), '6' (Offline), '7' (Test), '8' (Defer), '9' (Quiesce), '10' (Reboot) and/or '11' (Reset). If either '2' (Enabled) or '3' (Disabled) is supported, that both '2' (Enabled) and '3' (Disabled) shall be supported.
RequestedSpeedsSupported		Mandatory	Indicates the supported speeds that can be set in FCPortSettings.RequestedSpeed.
AutoSenseSpeedConfigurable		Mandatory	Indicates whether FCPortSettings.AutoSenseSpeed can be set to auto-negotiate speed.
RequestedTypesSupported		Mandatory	Indicates the list of supported port types that can be set in FCPortSettings.RequestedType.
NPIVSupported		Optional	Experimental.
MaxNPIVLogins		Optional	Experimental.

10.7.14 CIM_FCPortRateStatistics

Fibre Channel Switch Port Rate Statistics represent the rate per second over the SampleInterval. An instance of this class can represent the statistics for the current statistics, archived and consolidated statistics, or both.

Created By: Static

Modified By: Static

Deleted By: Static
Requirement: Optional

Table 109 describes class CIM_FCPortRateStatistics.

Table 109 - SMI Referenced Properties/Methods for CIM_FCPortRateStatistics

Properties	Flags	Requirement	Description & Notes
InstanceID		Mandatory	Opaque.
StatisticTime		Mandatory	The time the statistic was collected.
SampleInterval		Mandatory	The interval at which the rates are calculated.
TxFramerate		Optional	
RxFramerate		Optional	
MaxTxFrameRate		Optional	
MaxRxFrameRate		Optional	
TxRate		Mandatory	
RxRate		Mandatory	
PeakTxRate		Optional	
PeakRxRate		Optional	

10.7.15 CIM_FCPortSettings

Created By: Static
Modified By: Static
Deleted By: Static
Requirement: Optional

Table 110 describes class CIM_FCPortSettings.

Table 110 - SMI Referenced Properties/Methods for CIM_FCPortSettings

Properties	Flags	Requirement	Description & Notes
InstanceID		Mandatory	Opaque.
ElementName		Mandatory	Shall be 'FC Port Settings'.
RequestedSpeed	M	Mandatory	The requested value to which FCPort.Speed should be set.
AutoSenseSpeed	M	Mandatory	The request for the FCPort to auto sense the speed (FCPort.Speed).
RequestedType	M	Mandatory	The requested setting for the FCPort.PortType.

10.7.16 CIM_FCPortStatistics

Snapshot of performance and error counters for the Fibre Channel Switch.

Created By: Static
Modified By: Static
Deleted By: Static

Requirement: Mandatory

Table 111 describes class CIM_FCPortStatistics.

Table 111 - SMI Referenced Properties/Methods for CIM_FCPortStatistics

Properties	Flags	Requirement	Description & Notes
InstanceID		Mandatory	Opaque.
StatisticTime		Optional	The time the statistics were collected. If historical data is instantiated (present), this property shall be set with the time representing the time the statistic was collected.
ElementName		Optional	
BytesTransmitted		Mandatory	
BytesReceived		Mandatory	
PacketsTransmitted		Mandatory	
PacketsReceived		Mandatory	
CRCErrors		Mandatory	
LinkFailures		Mandatory	
PrimitiveSeqProtocolErrCount		Mandatory	
LIPCount		Optional	
NOSCount		Optional	
ErrorFrames		Optional	
DumpedFrames		Optional	
LossOfSignalCounter		Optional	
LossOfSyncCounter		Optional	
InvalidTransmissionWords		Optional	
FramesTooShort		Optional	
FramesTooLong		Optional	
AddressErrors		Optional	
BufferCreditNotProvided		Optional	
BufferCreditNotReceived		Optional	
DelimiterErrors		Optional	
EncodingDisparityErrors		Optional	
LinkResetsReceived		Optional	
LinkResetsTransmitted		Optional	
MulticastFramesReceived		Optional	
MulticastFramesTransmitted		Optional	
FBSYFrames		Optional	
PBSYFrames		Optional	
FRJTFrames		Optional	

Table 111 - SMI Referenced Properties/Methods for CIM_FCPortStatistics

Properties	Flags	Requirement	Description & Notes
PRJTFrames		Optional	
RXClass1Frames		Optional	
TXClass1Frames		Optional	
Class1FBSY		Optional	
Class1PBSY		Optional	
Class1FRJT		Optional	
Class1PRJT		Optional	
RXClass2Frames		Optional	
TXClass2Frames		Optional	
Class2FBSY		Optional	
Class2PBSY		Optional	
Class2FRJT		Optional	
Class2PRJT		Optional	
RXClass3Frames		Optional	
TXClass3Frames		Optional	
Class3FramesDiscarded		Optional	
RXBroadcastFrames		Optional	
TXBroadcastFrames		Optional	
FramePacingCount		Optional	Experimental. The number of 2.5 microsecond units that a frame transmission is blocked due to 0 BB credits.

10.7.17 CIM_FCSwitchCapabilities

Fibre Channel Switch Capabilities

EXPERIMENTAL

When the attached HBA supports FC-SB, and the switch is in a cascaded configuration, DomainIDConfigurable and DomainIDLimitedSupported shall be TRUE.

EXPERIMENTAL

Created By: Static

Modified By: Static

Deleted By: Static

Requirement: Mandatory

Table 112 describes class CIM_FCSwitchCapabilities.

Table 112 - SMI Referenced Properties/Methods for CIM_FCSwitchCapabilities

Properties	Flags	Requirement	Description & Notes
InstanceID		Mandatory	Opaque.
ElementName		Mandatory	Shall be 'FC Switch Capabilities'.
ElementNameEditSupported		Mandatory	Capability indicating whether ComputerSystem.ElementName for the switch can be set.
MaxElementNameLen		Mandatory	Capability specifying the maximum name of ComputerSystem.ElementName for the switch.
RequestedStatesSupported	N	Mandatory	The states the switch can support via ComputerSystem.RequestedState. If this property is NULL it means RequestedStateChange is not supported. Otherwise the values may be '2' (Enabled), '3' (Disabled), '4' (Shutdown), '6' (Offline), '7' (Test), '8' (Defer), '9' (Quiesce), '10' (Reboot) and/or '11' (Reset).
DomainIDConfigurable		Mandatory	Indicates whether the DomainID setting can be modified.
MinDomainID		Conditional	Conditional requirement: Support for DomainID configuration. Shall be set if DomainIDConfigurable is true.
MaxDomainID		Conditional	Conditional requirement: Support for DomainID configuration. Shall be set if DomainIDConfigurable is true.
DomainIDLockedSupported		Mandatory	
PrincipalPrioritiesSupported		Mandatory	
NPIVSupported		Optional	Experimental.

10.7.18 CIM_FCSwitchSettings

Fibre Channel Switch Settings

EXPERIMENTAL

When the attached HBA supports FC-SB, and the switch is in a cascaded configuration, PreferredDomainID shall be set to a unique value, and DomainIDLocked shall be true.

EXPERIMENTAL

Created By: Static
 Modified By: Static
 Deleted By: Static
 Requirement: Mandatory

Table 113 describes class CIM_FCSwitchSettings.

Table 113 - SMI Referenced Properties/Methods for CIM_FCSwitchSettings

Properties	Flags	Requirement	Description & Notes
InstanceID		Mandatory	Opaque.
ElementName		Mandatory	Shall be 'FC Switch Settings'.

Table 113 - SMI Referenced Properties/Methods for CIM_FCSwitchSettings

Properties	Flags	Requirement	Description & Notes
PreferredDomainID	M	Conditional	Conditional requirement: Support for DomainID configuration. Required if FCSwitchCapabilities.DomainIDConfigurable is TRUE.
DomainIDLocked	M	Conditional	Conditional requirement: Support for DomainID locking. Required if FCSwitchCapabilities.DomainIDLockSupported is TRUE.
PrincipalPriority	M	Conditional	Conditional requirement: Support for Principal Priorities. Required if FCSwitchCapabilities.PrincipalPrioritiesSupported is not set to 'Not Applicable'.

10.7.19 CIM_HostedCollection (Redundancy Set)

Created By: Static

Modified By: Static

Deleted By: Static

Requirement: Optional

Table 114 describes class CIM_HostedCollection (Redundancy Set).

Table 114 - SMI Referenced Properties/Methods for CIM_HostedCollection (Redundancy Set)

Properties	Flags	Requirement	Description & Notes
Antecedent		Mandatory	The switch ComputerSystem.
Dependent		Mandatory	The redundancy set of FCPorts.

10.7.20 CIM_HostedCollection (Statistics Collection)

Created By: Static

Modified By: Static

Deleted By: Static

Requirement: Mandatory

Table 115 describes class CIM_HostedCollection (Statistics Collection).

Table 115 - SMI Referenced Properties/Methods for CIM_HostedCollection (Statistics Collection)

Properties	Flags	Requirement	Description & Notes
Antecedent		Mandatory	The switch ComputerSystem.
Dependent		Mandatory	The Statistics Collection.

10.7.21 CIM_MemberOfCollection (FCPort to RedundancySet)

Created By: Static

Modified By: Static

Deleted By: Static

Requirement: Optional

Table 116 describes class CIM_MemberOfCollection (FCPort to RedundancySet).

Table 116 - SMI Referenced Properties/Methods for CIM_MemberOfCollection (FCPort to RedundancySet)

Properties	Flags	Requirement	Description & Notes
Member		Mandatory	The reference to the switch FCPort.
Collection		Mandatory	The reference to the RedundancySet.

10.7.22 CIM_MemberOfCollection (NetworkPortStatistics to StatisticalCollection)

Created By: Static

Modified By: Static

Deleted By: Static

Requirement: Mandatory

Table 117 describes class CIM_MemberOfCollection (NetworkPortStatistics to StatisticalCollection).

Table 117 - SMI Referenced Properties/Methods for CIM_MemberOfCollection (NetworkPortStatistics to StatisticalCollection)

Properties	Flags	Requirement	Description & Notes
Member		Mandatory	The reference to the FCPortStatistics.
Collection		Mandatory	The reference to the StatisticsCollection.

10.7.23 CIM_ProtocolEndpoint

The endpoint of a link (ActiveConnection). ProtocolEndpoint shall be implemented when BroadcastReset() is supported (Force LIP). It is expected that the Fabric Profile is also implemented which defines the necessary information for determining who will receive the Force LIP on the loop.

Created By: Static

Modified By: Static

Deleted By: Static

Requirement: Optional

Table 118 describes class CIM_ProtocolEndpoint.

Table 118 - SMI Referenced Properties/Methods for CIM_ProtocolEndpoint

Properties	Flags	Requirement	Description & Notes
SystemCreationClassName		Mandatory	The scoping System's CreationClassName.
SystemName		Mandatory	The scoping System's Name.
CreationClassName		Mandatory	Name of Class.
Name	CD	Mandatory	The Fibre Channel Port WWN.
NameFormat		Mandatory	'WWN'.
ProtocolIFType		Mandatory	Shall be 56 (Fibre Channel).

Table 118 - SMI Referenced Properties/Methods for CIM_ProtocolEndpoint

Properties	Flags	Requirement	Description & Notes
BroadcastResetSupported		Mandatory	
BroadcastReset()		Optional	Sends a Force LIP to all attached Ports. Required if BroadcastResetSupported is TRUE.

10.7.24 CIM_RedundancySet

Created By: Static

Modified By: Static

Deleted By: Static

Requirement: Optional

Table 119 describes class CIM_RedundancySet.

Table 119 - SMI Referenced Properties/Methods for CIM_RedundancySet

Properties	Flags	Requirement	Description & Notes
InstanceID		Mandatory	Opaque.
TypeOfSet		Mandatory	

10.7.25 CIM_StatisticsCollection

Created By: Static

Modified By: Static

Deleted By: Static

Requirement: Mandatory

Table 120 describes class CIM_StatisticsCollection.

Table 120 - SMI Referenced Properties/Methods for CIM_StatisticsCollection

Properties	Flags	Requirement	Description & Notes
InstanceID		Mandatory	Opaque.
ElementName		Mandatory	
SampleInterval		Mandatory	
TimeLastSampled		Mandatory	

10.7.26 CIM_SystemDevice

Created By: Static

Modified By: Static

Deleted By: Static

Requirement: Mandatory

Table 121 describes class CIM_SystemDevice.

Table 121 - SMI Referenced Properties/Methods for CIM_SystemDevice

Properties	Flags	Requirement	Description & Notes
PartComponent		Mandatory	The reference to the switch FCPort.
GroupComponent		Mandatory	The reference to the switch System.

STABLE

STABLE

11 Blades Profile

11.1 Synopsis

Profile Name: Blades (Component Profile)

Version: 1.7.0

Organization: SNIA

Central Class: PhysicalPackage

Scoping Class: a ComputerSystem in a referencing autonomous profile

Related Profiles: Not defined in this document.

11.2 Description

This profile describes how blades in a director class switch can be discovered and managed.

11.3 Instance Diagram

Figure 22 shows a Switch Blade instance.

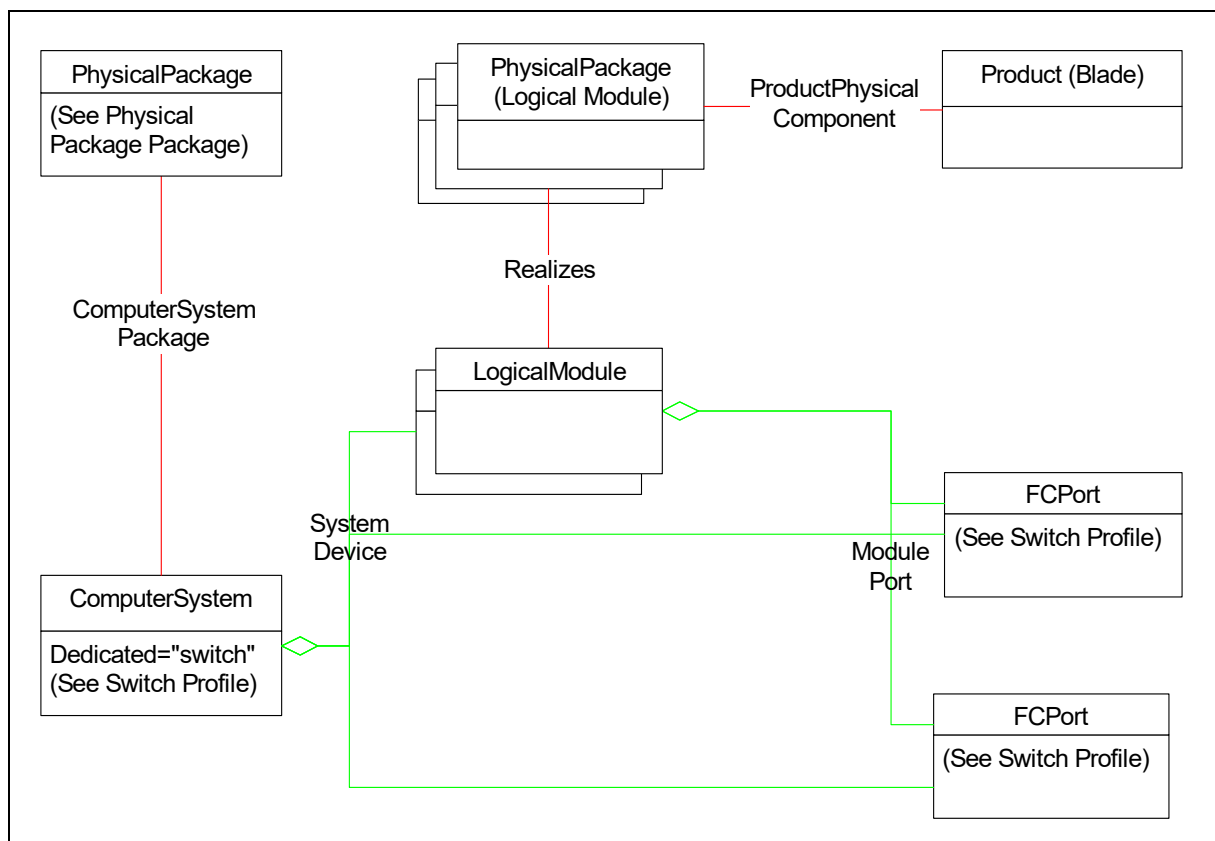

Figure 22 - Switch Blade Instance

11.4 Health and Fault Management

Not defined in this document

11.5 Cascading Considerations

Not defined in this document

11.6 Methods of this Profile

Not defined in this document

11.7 Use Cases

Not defined in this document.

11.8 CIM Elements

11.8.1 Overview

Table 122 describes the CIM elements for Blades.

Table 122 - CIM Elements for Blades

Element Name	Requirement	Description
11.8.2 CIM_LogicalModule	Mandatory	The Blade.
11.8.3 CIM_ModulePort	Mandatory	Associates the LogicalModule to the FCPort.
11.8.4 CIM_PhysicalPackage (Logical Module)	Mandatory	The physical package within which the LogicalModule is contained.
11.8.5 CIM_Product (Blade)	Optional	The product information for the Blade.
11.8.6 CIM_ProductPhysicalComponent	Optional	Associates the Product to the PhysicalPackage.
11.8.7 CIM_Realizes (Logical Module Package)	Optional	Associates the LogicalModule to its PhysicalPackage.
11.8.8 CIM_SystemDevice (Logical Module)	Mandatory	Associates the LogicalModule to the ComputerSystem representing the Switch.
SELECT * FROM CIM_InstCreation WHERE SourceInstance ISA CIM_LogicalModule	Optional	Creation of a Creation LogicalModule instance. See Section
SELECT * FROM CIM_InstDeletion WHERE SourceInstance ISA CIM_LogicalModule	Optional	Deletion of an LogicalModule instance.
SELECT * FROM CIM_InstModification WHERE SourceInstance ISA CIM_LogicalModule AND SourceInstance.CIM_LogicalModule::OperationalStatus <> PreviousInstance.CIM_LogicalModule::OperationalStatus	Optional	CQL -Change in status of LogicalModule.

11.8.2 CIM_LogicalModule

Created By: Static

Modified By: Static

Deleted By: Static

Requirement: Mandatory

Table 123 describes class CIM_LogicalModule.

Table 123 - SMI Referenced Properties/Methods for CIM_LogicalModule

Properties	Flags	Requirement	Description & Notes
SystemCreationClassName		Mandatory	
SystemName		Mandatory	
CreationClassName		Mandatory	
DeviceID		Mandatory	Opaque.
ElementName		Mandatory	
OperationalStatus		Mandatory	
ModuleNumber		Mandatory	

11.8.3 CIM_ModulePort

Created By: Static

Modified By: Static

Deleted By: Static

Requirement: Mandatory

Table 124 describes class CIM_ModulePort.

Table 124 - SMI Referenced Properties/Methods for CIM_ModulePort

Properties	Flags	Requirement	Description & Notes
PartComponent		Mandatory	A reference to a switch FCPort.
GroupComponent		Mandatory	A reference to a LogicalModule.

11.8.4 CIM_PhysicalPackage (Logical Module)

Created By: Static

Modified By: Static

Deleted By: Static

Requirement: Mandatory

Table 125 describes class CIM_PhysicalPackage (Logical Module).

Table 125 - SMI Referenced Properties/Methods for CIM_PhysicalPackage (Logical Module)

Properties	Flags	Requirement	Description & Notes
CreationClassName		Mandatory	
Tag		Mandatory	
ElementName		Optional	
Name		Optional	
Manufacturer		Mandatory	
Model		Mandatory	

Table 125 - SMI Referenced Properties/Methods for CIM_PhysicalPackage (Logical Module)

Properties	Flags	Requirement	Description & Notes
SerialNumber		Optional	
Version		Optional	
PartNumber		Optional	

11.8.5 CIM_Product (Blade)

Created By: Static

Modified By: Static

Deleted By: Static

Requirement: Optional

Table 126 describes class CIM_Product (Blade).

Table 126 - SMI Referenced Properties/Methods for CIM_Product (Blade)

Properties	Flags	Requirement	Description & Notes
Name		Mandatory	Commonly used Product name.
IdentifyingNumber		Mandatory	Product identification such as a serial number.
Vendor		Mandatory	The manufacturer or the OEM.
Version		Mandatory	Product version information.
ElementName		Mandatory	User Friendly name. Suggested use is Vendor, Version and product name.

11.8.6 CIM_ProductPhysicalComponent

Associates the Product to the PhysicalPackage. This is necessary to link the Product information to the Blade.

Created By: Static

Modified By: Static

Deleted By: Static

Requirement: Optional

Table 127 describes class CIM_ProductPhysicalComponent.

Table 127 - SMI Referenced Properties/Methods for CIM_ProductPhysicalComponent

Properties	Flags	Requirement	Description & Notes
GroupComponent		Mandatory	Reference to Product
PartComponent		Mandatory	Reference to PhysicalPackage

11.8.7 CIM_Realizes (Logical Module Package)

Created By: Static

Modified By: Static

Deleted By: Static

Requirement: Optional

Table 128 describes class CIM_Realizes (Logical Module Package).

Table 128 - SMI Referenced Properties/Methods for CIM_Realizes (Logical Module Package)

Properties	Flags	Requirement	Description & Notes
Antecedent		Mandatory	The reference to the PhysicalPackage.
Dependent		Mandatory	The reference to the LogicalModule representing the Blade.

11.8.8 CIM_SystemDevice (Logical Module)

Created By: Static

Modified By: Static

Deleted By: Static

Requirement: Mandatory

Table 129 describes class CIM_SystemDevice (Logical Module).

Table 129 - SMI Referenced Properties/Methods for CIM_SystemDevice (Logical Module)

Properties	Flags	Requirement	Description & Notes
GroupComponent		Mandatory	A reference to a Switch ComputerSystem.
PartComponent		Mandatory	A reference to a LogicalModule.

STABLE

EXPERIMENTAL

12 Switch Partitioning

12.1 Synopsis

Profile Name: Switch Partitioning (Component Profile)

Version: 1.5.0

Organization: SNIA

Central Class: CIM_ComputerSystem (Partitioning)

Scoping Class: a ComputerSystem in a referencing autonomous profile

Related Profiles: Table 130 describes the supported profiles for SwitchPartitioning.

Table 130 - Supported Profiles for SwitchPartitioning

Profile Name	Organization	Version	Requirement	Description
Physical Package	SNIA	1.5.0	Mandatory	

12.2 Description

The Switch Partitioning Profile is used when a “switch” actually is implementing multiple instances of a profile. The instances of the profile can be the same profiles, for example the Switch Profile, or different profiles, for example the Switch Profile and the Extender Profile. For the context of further discussion, the “switch” representing the entire set of systems will be called the Partitioning System and the systems that it is “hosting” are the Partitioned System. For virtual fabrics, ANSI T11 calls the partitioning system the “Core Switch” and the partitioned system the “Virtual Switch”. In other literature, a Partitioning System may be referred to as a Physical System or Physical Switch and a Partitioned Switch may be called a Logical Switch. In Figure 23: "Switch ComputerSystem and Partitioning System", an example is shown with a Partitioning System hosting a Partitioned System running the Extender Profile and the Switch Profile. The nomenclature in this profile uses blue to identify the partitioning entity.

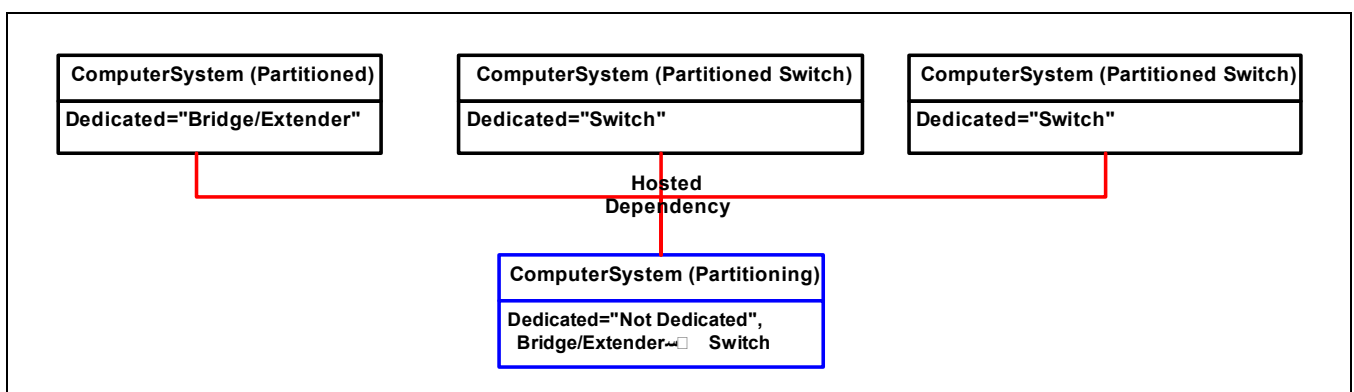

Figure 23 - Switch ComputerSystem and Partitioning System

The relationship between the Partitioning System and its partitions is indicated with the HostedDependency association. The Partitioning System can be determined by locating the ComputerSystem that is not a dependent in a HostedDependency relationship to another ComputerSystem. The Partitioning System also has the Dedicated property set to “Not Dedicated” plus the Dedicated values of the partitioned systems it supports.

In Figure 24: "Switch and Partitioning System and Partitioning Ports", the Partitioning Ports have been added. For this Profile, the NetworkPort class or a subclass is required to identify the partitioning entity.

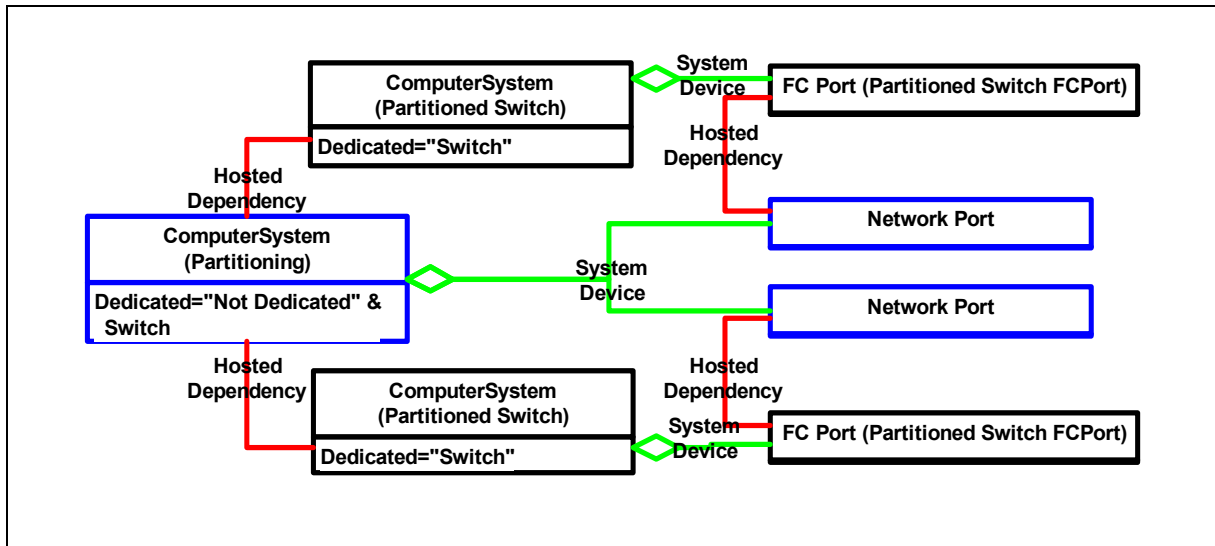

Figure 24 - Switch and Partitioning System and Partitioning Ports

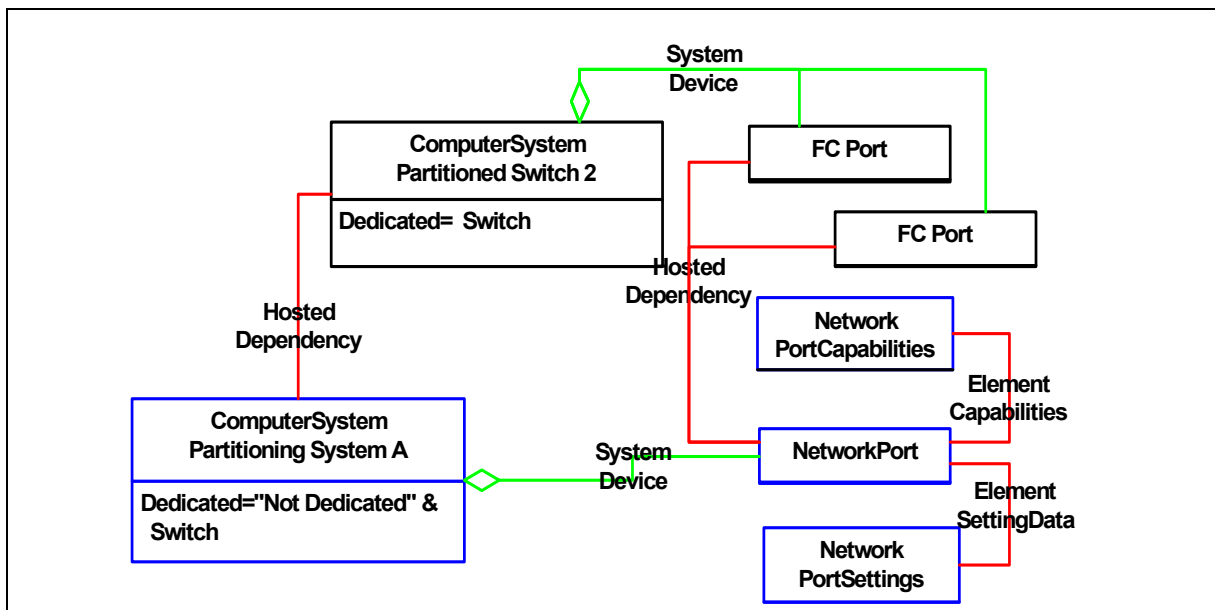

Figure 25 - Underlying System Port Settings and Capabilities

In Figure 25: "Underlying System Port Settings and Capabilities", there is the class **NetworkPortCapabilities** with the property `NetworkIDsConfigurable` which indicates whether this port can

be assigned to a particular fibre channel fabric. If this property is true, then the property, NetworkIDsFormat should be VF_ID and the array property NetworkIDs can be set to define which fibre channel virtual fabrics this port can belong to. When the port connects to one of the fibre channel fabrics in the setting, an FCPort instance shall be instantiated to represent the Fibre Channel Port that is active in the particular fabric with the association HostedDependency showing which NetworkPort the FCPort was partitioned from. If the setting contained more than one NetworkID, for every active connection to a fabric, an instance of FCPort shall be instantiated.

The FCSwitches partitioned from the partitioning ComputerSystem are implicitly created when a FCPort is connected to a virtual fabric. Currently there is no mechanism to explicitly create a partitioned switch.

The Physical Package Package is supported as part of this profile and shall be associated to the partitioning system. The partitioned systems may also be associated to the Physical Package Package if the partitioned system is defined in a separate profile. For example, the partitioned system in the Switch Profile may associate to the same instances of PhysicalPackage and Product that the partitioning system is associated to.

12.3 Health and Fault Management Consideration

Not defined in this document

12.4 Cascading Considerations

Not defined in this document

12.5 Methods of the Profile

Not defined in this document

12.6 Use Cases

Not defined in this document.

12.7 CIM Elements

12.7.1 Overview

Table 131 describes the CIM elements for SwitchPartitioning.

Table 131 - CIM Elements for SwitchPartitioning

Element Name	Requirement	Description
12.7.2 CIM_ComputerSystem (Partitioned)	Mandatory	The partitioned ComputerSystem.
12.7.3 CIM_ComputerSystem (Partitioning)	Mandatory	The partitioning ComputerSystem.
12.7.4 CIM_ElementCapabilities (Association between NetworkPort and NetworkPortCapabilities)	Mandatory	Association between NetworkPort and NetworkPortCapabilities.
12.7.5 CIM_ElementConformsToProfile (Partitioning ComputerSystem to Switch Partitioning RegisteredProfile)	Mandatory	Ties the Partitioning ComputerSystem to the registered profile for Switch Partitioning.
12.7.6 CIM_ElementSettingData (Association between NetworkPort and NetworkPortSettings)	Mandatory	Association between NetworkPort and NetworkPortSettings.
12.7.7 CIM_FCPort (Partitioned)	Mandatory	Fibre Channel Port on the partitioned system.
12.7.8 CIM_HostedDependency (NetworkPort to FCPort)	Mandatory	Association between NetworkPort to FCPort.
12.7.9 CIM_HostedDependency (Partitioning CS to Partitioned CS)	Mandatory	Association between the Partitioning ComputerSystem and Partitioned ComputerSystem.
12.7.10 CIM_NetworkPort (Partitioning)	Mandatory	The partitioning port.

Table 131 - CIM Elements for SwitchPartitioning

Element Name	Requirement	Description
12.7.11 CIM_NetworkPortCapabilities	Mandatory	The NetworkPort Capabilities.
12.7.12 CIM_NetworkPortSettings	Mandatory	Defines the Virtual Fabrics the switch port can connect to.
12.7.13 CIM_SystemDevice (FCPort to Partitioned ComputerSystem)	Mandatory	Associates the partitioned classes (FCPort to the ComputerSystem).
12.7.14 CIM_SystemDevice (NetworkPort to ComputerSystem)	Mandatory	Associates the partitioning classes (NetworkPort to the ComputerSystem).

12.7.2 CIM_ComputerSystem (Partitioned)

The ComputerSystem representing the Interconnect Element (e.g. a switch) or Platform (e.g. Host and Array).

Created By: External

Modified By: Static

Deleted By: External

Requirement: Mandatory

Table 132 describes class CIM_ComputerSystem (Partitioned).

Table 132 - SMI Referenced Properties/Methods for CIM_ComputerSystem (Partitioned)

Properties	Flags	Requirement	Description & Notes
CreationClassName		Mandatory	Name of Class.
Name	C	Mandatory	The Partitioned System Name. The name shall be correlateable to the system represented (e.g., a Switch).
Dedicated		Mandatory	
OtherIdentifyingInfo		Conditional	Conditional requirement: Required if the Virtual Fabrics profile is implemented. One of the entries shall contain the Virtual Fabric ID for the virtual fabric (if virtual fabrics is implemented). Other entries in OtherIdentifyingInfo define the partitioned system (e.g., Switch OtherIdentifyInfo if the Partitioned system is a Switch).
IdentifyingDescriptions		Conditional	Conditional requirement: Required if the Virtual Fabrics profile is implemented. One of the entries shall contain 'SNIA:VF_ID' for the virtual fabric (if virtual fabrics is implemented). Other entries in IdentifyingDescriptions define the partitioned system (e.g., Switch IdentifyDescriptions if the Partitioned system is a Switch).

12.7.3 CIM_ComputerSystem (Partitioning)

The ComputerSystem representing the Interconnect Element (e.g. a switch) or Platform (e.g. Host and Array).

Created By: External

Modified By: Static

Deleted By: External

Requirement: Mandatory

Table 133 describes class CIM_ComputerSystem (Partitioning).

Table 133 - SMI Referenced Properties/Methods for CIM_ComputerSystem (Partitioning)

Properties	Flags	Requirement	Description & Notes
CreationClassName		Mandatory	Name of Class.
Name		Mandatory	The Partitioning System Name.
Dedicated		Mandatory	

12.7.4 CIM_ElementCapabilities (Association between NetworkPort and NetworkPortCapabilities)

Association between NetworkPort and NetworkPortCapabilities.

Created By: Static

Modified By: Static

Deleted By: Static

Requirement: Mandatory

Table 134 describes class CIM_ElementCapabilities (Association between NetworkPort and NetworkPortCapabilities).

Table 134 - SMI Referenced Properties/Methods for CIM_ElementCapabilities (Association between NetworkPort and NetworkPortCapabilities)

Properties	Flags	Requirement	Description & Notes
ManagedElement		Mandatory	The reference to the NetworkPort.
Capabilities		Mandatory	The reference to the NetworkPortCapabilities.

12.7.5 CIM_ElementConformsToProfile (Partitioning ComputerSystem to Switch Partitioning RegisteredProfile)

The CIM_ElementConformsToProfile ties Partitioning ComputerSystem to the registered profile for Switch Partitioning.

Created By: Static

Modified By: Static

Deleted By: Static

Requirement: Mandatory

Table 135 describes class CIM_ElementConformsToProfile (Partitioning ComputerSystem to Switch Partitioning RegisteredProfile).

Table 135 - SMI Referenced Properties/Methods for CIM_ElementConformsToProfile (Partitioning ComputerSystem to Switch Partitioning RegisteredProfile)

Properties	Flags	Requirement	Description & Notes
ManagedElement		Mandatory	A Partitioning ComputerSystem that represents the a base system supporting partitioned systems.
ConformantStandard		Mandatory	RegisteredProfile instance describing the Switch Partitioning profile.

12.7.6 CIM_ElementSettingData (Association between NetworkPort and NetworkPortSettings)

Association between NetworkPort and NetworkPortSettings.

Created By: Static
 Modified By: Static
 Deleted By: Static
 Requirement: Mandatory

Table 136 describes class CIM_ElementSettingData (Association between NetworkPort and NetworkPortSettings).

Table 136 - SMI Referenced Properties/Methods for CIM_ElementSettingData (Association between NetworkPort and NetworkPortSettings)

Properties	Flags	Requirement	Description & Notes
SettingData		Mandatory	The reference to the NetworkPortSettings.
ManagedElement		Mandatory	The reference to the NetworkPort.

12.7.7 CIM_FCPort (Partitioned)

Fibre Channel Port on the partitioned system. (e.g., a switch partition).

Created By: Static
 Modified By: Static
 Deleted By: Static
 Requirement: Mandatory

Table 137 describes class CIM_FCPort (Partitioned).

Table 137 - SMI Referenced Properties/Methods for CIM_FCPort (Partitioned)

Properties	Flags	Requirement	Description & Notes
SystemCreationClassName		Mandatory	The scoping System's CreationClassName.
SystemName		Mandatory	The scoping System's Name.
CreationClassName		Mandatory	Name of Class.
DeviceID		Mandatory	Opaque.
ElementName		Optional	Port Symbolic Name if available. Otherwise NULL. If the underlying implementation includes characters that are illegal in CIM strings, then truncate before the first of those characters.
PermanentAddress	CD	Mandatory	Fibre Channel Port WWN. Expressed as 16 un-separated upper case hex digits.
NetworkAddresses	C	Mandatory	Fibre Channel ID (FCID). Expressed as 8 un-separated upper case hex digits.
OperationalStatus		Mandatory	The operational status of the FC Port.
PortType		Mandatory	The specific port type currently enabled (from FC-GS Port.Type).
LinkTechnology		Mandatory	Shall be 4 ('FC').

Table 137 - SMI Referenced Properties/Methods for CIM_FCPort (Partitioned)

Properties	Flags	Requirement	Description & Notes
SupportedFC4Types		Optional	An array of integers indicating the Fibre Channel FC-4 protocols supported. When supporting FC-SB, this property shall be either '27' (FC-SB-2 Channel) for Host Ports or '28' (FC-SB-2 Control Unit) for targets.
SupportedCOS		Optional	An array of integers indicating the Fibre Channel Classes of Service that are supported. When supporting FC-SB, this property shall be either '2' or '3' for FC-SB-2 Channel or FC-SB-2 Control Unit ports, respectively.

12.7.8 CIM_HostedDependency (NetworkPort to FCPort)

The association between the partitioning NetworkPort and the partitioned FCPort. The Antecedent references the partitioning port and the Dependent references the partitioned port. The association can be used to determine whether the system is in the underlying SAN topology or the Fabric topology.

Created By: Static

Modified By: Static

Deleted By: Static

Requirement: Mandatory

Table 138 describes class CIM_HostedDependency (NetworkPort to FCPort).

Table 138 - SMI Referenced Properties/Methods for CIM_HostedDependency (NetworkPort to FCPort)

Properties	Flags	Requirement	Description & Notes
Antecedent		Mandatory	NetworkPort representing the Partitioning System.
Dependent		Mandatory	FCPort representing the Partitioned System.

12.7.9 CIM_HostedDependency (Partitioning CS to Partitioned CS)

The association between the Partitioning ComputerSystem and the Partitioned ComputerSystem. The Antecedent references the partitioning system and the Dependent references the partitioned system. The association can be used to determine whether the system is in the underlying SAN topology or the Fabric topology.

Created By: Static

Modified By: Static

Deleted By: Static

Requirement: Mandatory

Table 139 describes class CIM_HostedDependency (Partitioning CS to Partitioned CS).

Table 139 - SMI Referenced Properties/Methods for CIM_HostedDependency (Partitioning CS to Partitioned CS)

Properties	Flags	Requirement	Description & Notes
Antecedent		Mandatory	ComputerSystem representing the Partitioning System.
Dependent		Mandatory	ComputerSystem representing the Partitioned System.

12.7.10 CIM_NetworkPort (Partitioning)

The partitioning port.

Created By: External

Modified By: Static

Deleted By: External

Requirement: Mandatory

Table 140 describes class CIM_NetworkPort (Partitioning).

Table 140 - SMI Referenced Properties/Methods for CIM_NetworkPort (Partitioning)

Properties	Flags	Requirement	Description & Notes
SystemCreationClassName		Mandatory	The scoping System's CreationClassName.
SystemName		Mandatory	The scoping System's Name.
CreationClassName		Mandatory	Name of Class.
DeviceID		Mandatory	Opaque.

12.7.11 CIM_NetworkPortCapabilities

The NetworkPort Capabilities.

Created By: Static

Modified By: Static

Deleted By: Static

Requirement: Mandatory

Table 141 describes class CIM_NetworkPortCapabilities.

Table 141 - SMI Referenced Properties/Methods for CIM_NetworkPortCapabilities

Properties	Flags	Requirement	Description & Notes
InstanceID		Mandatory	Opaque.
ElementName		Mandatory	Shall be set to "NetworkPortCapabilities".
NetworkIDsConfigurable		Mandatory	If the switch supports configuring virtual fabrics, this property shall be TRUE. If the switch only supports discovery, this property shall be FALSE.
NetworkIDsFormat		Mandatory	For configuring virtual fabrics, this property shall be VF_ID.

12.7.12 CIM_NetworkPortSettings

Defines the Virtual Fabrics the switch port can connect to. The property NetworkIDs is an array which should contain the Virtual Fabric IDs (VF_ID) that the NetworkPort will partition FCPorts for.

Created By: Static

Modified By: Static

Deleted By: Static

Requirement: Mandatory

Table 142 describes class CIM_NetworkPortSettings.

Table 142 - SMI Referenced Properties/Methods for CIM_NetworkPortSettings

Properties	Flags	Requirement	Description & Notes
InstanceID		Mandatory	Opaque.
ElementName		Mandatory	Shall be set to "NetworkPortSettings".
NetworkIDs		Mandatory	Contains the Virtual Fabric IDs that the NetworkPort will host FCPorts for.

12.7.13 CIM_SystemDevice (FCPort to Partitioned ComputerSystem)

Associates the FCPort to the partitioned ComputerSystem.

Created By: External

Modified By: Static

Deleted By: External

Requirement: Mandatory

Table 143 describes class CIM_SystemDevice (FCPort to Partitioned ComputerSystem).

Table 143 - SMI Referenced Properties/Methods for CIM_SystemDevice (FCPort to Partitioned ComputerSystem)

Properties	Flags	Requirement	Description & Notes
GroupComponent		Mandatory	The reference to the partitioned ComputerSystem.
PartComponent		Mandatory	The reference to the partitioned FCPort.

12.7.14 CIM_SystemDevice (NetworkPort to ComputerSystem)

Associates the NetworkPort to the ComputerSystem.

Created By: External

Modified By: Static

Deleted By: External

Requirement: Mandatory

Table 144 describes class CIM_SystemDevice (NetworkPort to ComputerSystem).

Table 144 - SMI Referenced Properties/Methods for CIM_SystemDevice (NetworkPort to ComputerSystem)

Properties	Flags	Requirement	Description & Notes
GroupComponent		Mandatory	The reference to the ComputerSystem.
PartComponent		Mandatory	The reference to the NetworkPort.

EXPERIMENTAL

EXPERIMENTAL
13 N Port Virtualizer Profile**13.1 Synopsis****Profile Name:** N Port Virtualizer (Component Profile)**Version:** 1.7.0**Organization:** SNIA**Central Class:** CIM_FCPort (Fabric NPIV)**Scoping Class:** AdminDomain**Related Profiles:** Table 145 describes the supported profiles for N Port Virtualizer.**Table 145 - Supported Profiles for N Port Virtualizer**

Profile Name	Organization	Version	Requirement	Description
Physical Package	SNIA	1.5.0	Conditional	Conditional requirement: Required if the Switch profile is implemented.
Switch	SNIA	1.8.0	Optional	

13.2 Description

The N Port Virtualizer Profile is a component profile of the Fabric Profile that adds additional classes and places requirements on the FCPort class of the Fabric Profile.

13.3 Implementation

Figure 26 illustrates the main elements in modeling of an N Port Virtualizer.

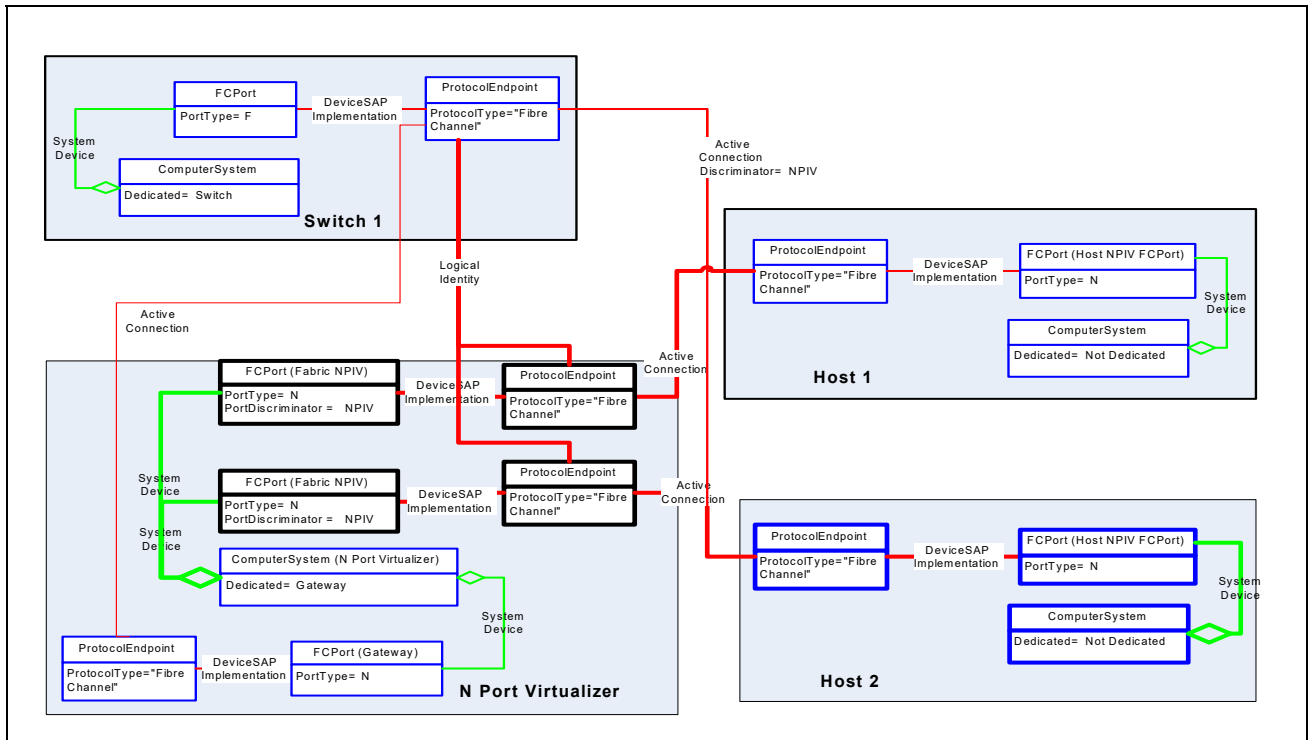

Figure 26 - N Port Virtualizer

Figure 26 shows elements in the Fabric Profile as they relate to the elements of the N Port Virtualizer Profile. The classes of the N Port Virtualizer are in the lower left box with association to class instances in the Fabric Profile. The key elements of the N Port Virtualizer are:

- An N Port Virtualizer ComputerSystem (with a Dedicated property of “Gateway”)
- FCPorts with an PortDiscriminator property of “NPIV”
- One (or more) FCPorts for connecting the N Port Virtualizer system to the Switch system
- ProtocolEndpoints for all the FCPorts in the N Port Virtualizer
- All the FCPorts in the N Port Virtualizer are scoped to the N Port Virtualizer ComputerSystem
- ActiveConnection associations between the ProtocolEndpoints in Platform ComputerSystems (of Fabric) and the ProtocolEndpoints for the NPIV FCPorts in the N Port Virtualizer

The ActiveConnections essentially represent connections between host system ports and the NPIV ports of the N Port Virtualizer (similar to going to switch ports when the N Port Virtualizer is not present).

NOTE In addition to the ActiveConnections between the Platform ports and the NPIV ports, ActiveConnections are also instantiated for the actual switch port to which the NPIV port provides connectivity to. When the N Port Virtualizer is implemented it adds a constraint on the ActiveConnections between Platform FCPorts and Switch FCPorts. The ActiveConnection shall be subclassed to FCActiveConnection and contain the Discriminator property which shall contain a value of ‘3’ (NPIV) for FCActiveConnections that are effected through the N Port Virtualizer.

- LogicalIdentity associations between the NPIV FCPorts and the Switch FCPorts to represent the Switch FCPort that is supporting the NPIV FCPort.

13.4 Health and Fault Management Consideration

Not defined in this document.

13.5 Cascading Considerations

Not defined in this document.

13.6 Methods of the Profile

Not defined in this document.

13.7 Use Cases

Not defined in this document.

13.8 CIM Elements

13.8.1 Overview

Table 146 describes the CIM elements for N Port Virtualizer.

Table 146 - CIM Elements for N Port Virtualizer

Element Name	Requirement	Description
13.8.2 CIM_Component (N Port Virtualizer to Fabric)	Mandatory	Aggregates N Port Virtualizers in the AdminDomain that represents the Fabric.
13.8.3 CIM_ComputerSystem (N Port Virtualizer)	Mandatory	The ComputerSystem representing the N Port Virtualizer.
13.8.4 CIM_ComputerSystemPackage (N Port Virtualizer to Physical Package)	Conditional	Conditional requirement: Required if the Switch profile is implemented. Associates PhysicalPackage to the ComputerSystem (N Port Virtualizer).
13.8.5 CIM_DeviceSAPImplementation (ProtocolEndpoint to Gateway FCPort)	Mandatory	Associates the N Port Virtualizer Gateway FCPort to its ProtocolEndpoint.
13.8.6 CIM_DeviceSAPImplementation (ProtocolEndpoint to NPIV FCPort)	Mandatory	Associates the N Port Virtualizer NPIV FCPort to its ProtocolEndpoint.
13.8.7 CIM_FCActiveConnection (Gateway)	Optional	The association between ProtocolEndpoints representing the links between fibre channel switch ports and N Port Virtualizer gateway ports that are used to effect active connections between platform and switch ports.
13.8.8 CIM_FCActiveConnection (N Port Virtualization)	Optional	The association between ProtocolEndpoints representing the links between fibre channel platform ports and switch ports that are effected through an N Port Virtualizer.
13.8.9 CIM_FCPort (Fabric NPIV)	Mandatory	NPIV Fibre Channel Ports of the N Port Virtualizer.
13.8.10 CIM_FCPort (Gateway)	Mandatory	A Fibre Channel Port of the N Port Virtualizer that is used to connect to Switch Ports.
13.8.11 CIM_HostedAccessPoint (N Port Virtualizer System to ProtocolEndpoint)	Mandatory	Associates the ProtocolEndpoint to the N Port Virtualizer ComputerSystem.
13.8.12 CIM_LogicalIdentity (NPIV Port to Switch Port)	Mandatory	Associates ProtocolEndpoints of N Port Virtualizer NPIV FCPorts to ProtocolEndpoints of Switch FCPorts.
13.8.13 CIM_ProtocolEndpoint (N Port Virtualizer)	Mandatory	The endpoint of a link (ActiveConnection) on the N Port Virtualizer.
13.8.14 CIM_SystemDevice (N Port Virtualizer Gateway FCPort to Gateway System)	Optional	Associates N Port Virtualizer Gateway FCPorts to the ComputerSystem (N Port Virtualizer).
13.8.15 CIM_SystemDevice (N Port Virtualizer NPIV FCPort to Gateway System)	Optional	Associates N Port Virtualizer NPIV FCPorts to the ComputerSystem (N Port Virtualizer).

13.8.2 CIM_Component (N Port Virtualizer to Fabric)

Aggregates N Port Virtualizers in the AdminDomain that represents the Fabric.

Created By: Static
 Modified By: Static
 Deleted By: Static
 Requirement: Mandatory

Table 147 describes class CIM_Component (N Port Virtualizer to Fabric).

Table 147 - SMI Referenced Properties/Methods for CIM_Component (N Port Virtualizer to Fabric)

Properties	Flags	Requirement	Description & Notes
PartComponent		Mandatory	Reference to an N Port Virtualizer (a ComputerSystem with Dedicated='20').
GroupComponent		Mandatory	Reference to the AdminDomain representing the Fabric (OtherIdentifyingInfo contains 'Fabric' with a corresponding 'SNIA:DetailedType' in IdentifyingDescriptions').

13.8.3 CIM_ComputerSystem (N Port Virtualizer)

The ComputerSystem representing the N Port Virtualizer.

Created By: Static
 Modified By: Static
 Deleted By: Static
 Requirement: Mandatory

Table 148 describes class CIM_ComputerSystem (N Port Virtualizer).

Table 148 - SMI Referenced Properties/Methods for CIM_ComputerSystem (N Port Virtualizer)

Properties	Flags	Requirement	Description & Notes
CreationClassName		Mandatory	Name of Class.
Name	C	Mandatory	This shall be the WWN for the N Port Virtualizer gateway.
ElementName		Mandatory	The N Port Virtualizer Symbolic Name.
NameFormat		Mandatory	Shall be 'WWN'.
OperationalStatus		Mandatory	One of the defined values (2 3 6 8 9 10 11 12 13) shall be present in the array value.
OtherIdentifyingInfo		Optional	
Dedicated		Mandatory	Shall be '20' (Gateway).
IdentifyingDescriptions		Optional	

13.8.4 CIM_ComputerSystemPackage (N Port Virtualizer to Physical Package)

Associates PhysicalPackage to the ComputerSystem (N Port Virtualizer). This is required if the Switch Profile is implemented.

Created By: Static

Modified By: Static

Deleted By: Static

Requirement: Required if the Switch profile is implemented.

Table 149 describes class CIM_ComputerSystemPackage (N Port Virtualizer to Physical Package).

Table 149 - SMI Referenced Properties/Methods for CIM_ComputerSystemPackage (N Port Virtualizer to Physical Package)

Properties	Flags	Requirement	Description & Notes
Antecedent		Mandatory	The reference to the PhysicalPackage.
Dependent		Mandatory	The reference to the Switch ComputerSystem.

13.8.5 CIM_DeviceSAPImplementation (ProtocolEndpoint to Gateway FCPort)

Associates the N Port Virtualizer Gateway FCPort to its ProtocolEndpoint.

Created By: Static

Modified By: Static

Deleted By: Static

Requirement: Mandatory

Table 150 describes class CIM_DeviceSAPImplementation (ProtocolEndpoint to Gateway FCPort).

Table 150 - SMI Referenced Properties/Methods for CIM_DeviceSAPImplementation (ProtocolEndpoint to Gateway FCPort)

Properties	Flags	Requirement	Description & Notes
Dependent		Mandatory	Reference to the ProtocolEndpoint.
Antecedent		Mandatory	Reference to the Gateway FCPort.

13.8.6 CIM_DeviceSAPImplementation (ProtocolEndpoint to NPIV FCPort)

Associates the N Port Virtualizer NPIV FCPort to its ProtocolEndpoint.

Created By: Static

Modified By: Static

Deleted By: Static

Requirement: Mandatory

Table 151 describes class CIM_DeviceSAPImplementation (ProtocolEndpoint to NPIV FCPort).

Table 151 - SMI Referenced Properties/Methods for CIM_DeviceSAPImplementation (ProtocolEndpoint to NPIV FCPort)

Properties	Flags	Requirement	Description & Notes
Dependent		Mandatory	Reference to the ProtocolEndpoint.
Antecedent		Mandatory	Reference to the NPIV FCPort (PortDiscriminator='7').

13.8.7 CIM_FCActiveConnection (Gateway)

The association between ProtocolEndpoints representing the links between fibre channel switch ports and N Port Virtualizer gateway ports that are used to effect active connections between platform and switch ports. Gateway FCActiveConnections are part of this profile.

Created By: Static
 Modified By: Static
 Deleted By: Static
 Requirement: Optional

Table 152 describes class CIM_FCActiveConnection (Gateway).

Table 152 - SMI Referenced Properties/Methods for CIM_FCActiveConnection (Gateway)

Properties	Flags	Requirement	Description & Notes
Discriminator		Optional	For ActiveConnections that are instantiated to represent connections established through an N Port Virtualizer, the value shall include '3' (NPIV).
Antecedent		Mandatory	The reference to the ProtocolEndpoint in the switch.
Dependent		Mandatory	The reference to the ProtocolEndpoint in the N Port Virtualizer.

13.8.8 CIM_FCActiveConnection (N Port Virtualization)

The association between ProtocolEndpoints representing the links between fibre channel platform ports and switch ports that are effected through an N Port Virtualizer. This class table is a constrain on the ActiveConnection in the Fabric Profile.

Created By: Static
 Modified By: Static
 Deleted By: Static
 Requirement: Optional

Table 153 describes class CIM_FCActiveConnection (N Port Virtualization).

Table 153 - SMI Referenced Properties/Methods for CIM_FCActiveConnection (N Port Virtualization)

Properties	Flags	Requirement	Description & Notes
Discriminator		Optional	For ActiveConnections that are instantiated to represent connections established through an N Port Virtualizer, the value shall include '3' (NPIV).
Antecedent		Mandatory	The reference to the ProtocolEndpoint for one end of the link.
Dependent		Mandatory	The reference to the ProtocolEndpoint for the other end of the link.

13.8.9 CIM_FCPort (Fabric NPIV)

NPIV Fibre Channel Ports of the N Port Virtualizer. These are ports that support NPIV and are realized through switch ports.

Created By: Static
 Modified By: Static

Deleted By: Static
Requirement: Mandatory

Table 154 describes class CIM_FCPort (Fabric NPIV).

Table 154 - SMI Referenced Properties/Methods for CIM_FCPort (Fabric NPIV)

Properties	Flags	Requirement	Description & Notes
SystemCreationClassName		Mandatory	The N Port Virtualizer System's CreationClassName.
SystemName		Mandatory	The N Port Virtualizer System's Name.
CreationClassName		Mandatory	Name of Class.
DeviceID		Mandatory	Opaque.
ElementName		Optional	Port Symbolic Name if available. Otherwise NULL. If the underlying implementation includes characters that are illegal in CIM strings, then truncate before the first of those characters.
PermanentAddress	CD	Mandatory	Fibre Channel Port WWN. Expressed as 16 un-separated upper case hex digits.
NetworkAddresses	C	Mandatory	Fibre Channel ID (FCID). Expressed as 8 un-separated upper case hex digits.
OperationalStatus		Mandatory	One of the defined values (0 2 6 10 11) shall be present in the array value.
PortType		Mandatory	This shall be port type '10' (N).
LinkTechnology		Mandatory	Shall be 4 ('FC').
SupportedFC4Types		Optional	An array of integers indicating the Fibre Channel FC-4 protocols supported. When supporting FC-SB, this property shall be either '27' (FC-SB-2 Channel) for Host Ports or '28' (FC-SB-2 Control Unit) for targets.
SupportedCOS		Optional	An array of integers indicating the Fibre Channel Classes of Service that are supported. When supporting FC-SB, this property shall be either '2' or '3' for FC-SB-2 Channel or FC-SB-2 Control Unit ports, respectively..
PortDiscriminator		Mandatory	This array property identifies the context in which this FCPort is instantiated. For the Fabric NPIV FC Ports, the values shall include '7' (NPIV).

13.8.10 CIM_FCPort (Gateway)

A Fibre Channel Port of the N Port Virtualizer that is used to connect to Switch Ports. These are ports are the active connection between the N Port Virtualizer system and the Switch ports in the Fabric.

Created By: Static
Modified By: Static
Deleted By: Static
Requirement: Mandatory

Table 155 describes class CIM_FCPort (Gateway).

Table 155 - SMI Referenced Properties/Methods for CIM_FCPort (Gateway)

Properties	Flags	Requirement	Description & Notes
SystemCreationClassName		Mandatory	The N Port Virtualizer System's CreationClassName.
SystemName		Mandatory	The N Port Virtualizer System's Name.
CreationClassName		Mandatory	Name of Class.
DeviceID		Mandatory	Opaque.
ElementName		Optional	Port Symbolic Name if available. Otherwise NULL. If the underlying implementation includes characters that are illegal in CIM strings, then truncate before the first of those characters.
PermanentAddress	CD	Mandatory	Fibre Channel Port WWN. Expressed as 16 un-separated upper case hex digits.
NetworkAddresses	C	Mandatory	Fibre Channel ID (FCID). Expressed as 8 un-separated upper case hex digits.
OperationalStatus		Mandatory	One of the defined values (0 2 6 10 11) shall be present in the array value.
PortType		Mandatory	This shall be port type '10' (N).
LinkTechnology		Mandatory	Shall be 4 ('FC').
SupportedFC4Types		Optional	An array of integers indicating the Fibre Channel FC-4 protocols supported. When supporting FC-SB, this property shall be either '27' (FC-SB-2 Channel) for Host Ports or '28' (FC-SB-2 Control Unit) for targets.
SupportedCOS		Optional	An array of integers indicating the Fibre Channel Classes of Service that are supported. When supporting FC-SB, this property shall be either '2' or '3' for FC-SB-2 Channel or FC-SB-2 Control Unit ports, respectively.
PortDiscriminator		Mandatory	This array property identifies the context in which this FCPort is instantiated. For this version of the standard, the values shall not contain '7' (NPIV).

13.8.11 CIM_HostedAccessPoint (N Port Virtualizer System to ProtocolEndpoint)

Associates the ProtocolEndpoint to the N Port Virtualizer ComputerSystem.

Created By: Static

Modified By: Static

Deleted By: Static

Requirement: Mandatory

Table 156 describes class CIM_HostedAccessPoint (N Port Virtualizer System to ProtocolEndpoint).

Table 156 - SMI Referenced Properties/Methods for CIM_HostedAccessPoint (N Port Virtualizer System to ProtocolEndpoint)

Properties	Flags	Requirement	Description & Notes
Dependent		Mandatory	Reference to the ProtocolEndpoint.
Antecedent		Mandatory	Reference to the N Port Virtualizer ComputerSystem.

13.8.12 CIM_LogicalIdentity (NPIV Port to Switch Port)

Associates ProtocolEndpoints of N Port Virtualizer NPIV FCPorts to ProtocolEndpoints of Switch FCPorts.

Created By: Static

Modified By: Static

Deleted By: Static

Requirement: Mandatory

Table 157 describes class CIM_LogicalIdentity (NPIV Port to Switch Port).

Table 157 - SMI Referenced Properties/Methods for CIM_LogicalIdentity (NPIV Port to Switch Port)

Properties	Flags	Requirement	Description & Notes
SystemElement		Mandatory	This is a reference to an N Port Virtualizer ProtocolEndpoint for an NPIV FCPort.
SameElement		Mandatory	This is a reference to Switch ProtocolEndpoint that supports the N Port Virtualizer ProtocolEndpoint.

13.8.13 CIM_ProtocolEndpoint (N Port Virtualizer)

The endpoint of a link (ActiveConnection). ProtocolEndpoint shall be implemented when an ActiveConnection exists. It may be implemented if no ActiveConnections exist.

Created By: Static

Modified By: Static

Deleted By: Static

Requirement: Mandatory

Table 158 describes class CIM_ProtocolEndpoint (N Port Virtualizer).

Table 158 - SMI Referenced Properties/Methods for CIM_ProtocolEndpoint (N Port Virtualizer)

Properties	Flags	Requirement	Description & Notes
SystemCreationClassName		Mandatory	The N Port Virtualizer System's CreationClassName.
SystemName		Mandatory	The N Port Virtualizer System's Name.
CreationClassName		Mandatory	Name of Class.
Name	CD	Mandatory	The Fibre Channel Port WWN.
NameFormat		Mandatory	'WWN'.
ProtocolIFType		Mandatory	Shall be 56(Fibre channel).

13.8.14 CIM_SystemDevice (N Port Virtualizer Gateway FCPort to Gateway System)

Associates N Port Virtualizer Gateway FCPorts to the ComputerSystem (N Port Virtualizer).

Created By: Static
 Modified By: Static
 Deleted By: Static
 Requirement: Optional

Table 159 describes class CIM_SystemDevice (N Port Virtualizer Gateway FCPort to Gateway System).

Table 159 - SMI Referenced Properties/Methods for CIM_SystemDevice (N Port Virtualizer Gateway FCPort to Gateway System)

Properties	Flags	Requirement	Description & Notes
PartComponent		Mandatory	The reference to the Gateway FCPort.
GroupComponent		Mandatory	The reference to the N Port Virtualizer ComputerSystem.

13.8.15 CIM_SystemDevice (N Port Virtualizer NPIV FCPort to Gateway System)

Associates N Port Virtualizer NPIV FCPorts to the ComputerSystem (N Port Virtualizer).

Created By: Static
 Modified By: Static
 Deleted By: Static
 Requirement: Optional

Table 160 describes class CIM_SystemDevice (N Port Virtualizer NPIV FCPort to Gateway System).

Table 160 - SMI Referenced Properties/Methods for CIM_SystemDevice (N Port Virtualizer NPIV FCPort to Gateway System)

Properties	Flags	Requirement	Description & Notes
PartComponent		Mandatory	The reference to the Fabric NPIV FCPort.
GroupComponent		Mandatory	The reference to the N Port Virtualizer ComputerSystem.

EXPERIMENTAL

EXPERIMENTAL

14 Inter Fabric Routing Profile

14.1 Synopsis

Profile Name: Inter Fabric Routing (Component Profile)

Version: 1.7.0

Organization: SNIA

Central Class: CIM_ComputerSystem (IFR Switch)

Scoping Class: AdminDomain

Related Profiles: Not defined in this document.

14.2 Description

14.2.1 Overview

This profile defines the mechanism to model Inter Fabric Routing (IFR) as defined in the T11 document FC-IFR. IFR is a fibre channel standard that allows a device in one fabric to be shared in another fabric without having to merge the two fabrics into a single fabric.

14.2.2 Switch Topology

Figure 27 illustrates the switch topology for Inter Fabric Routing.

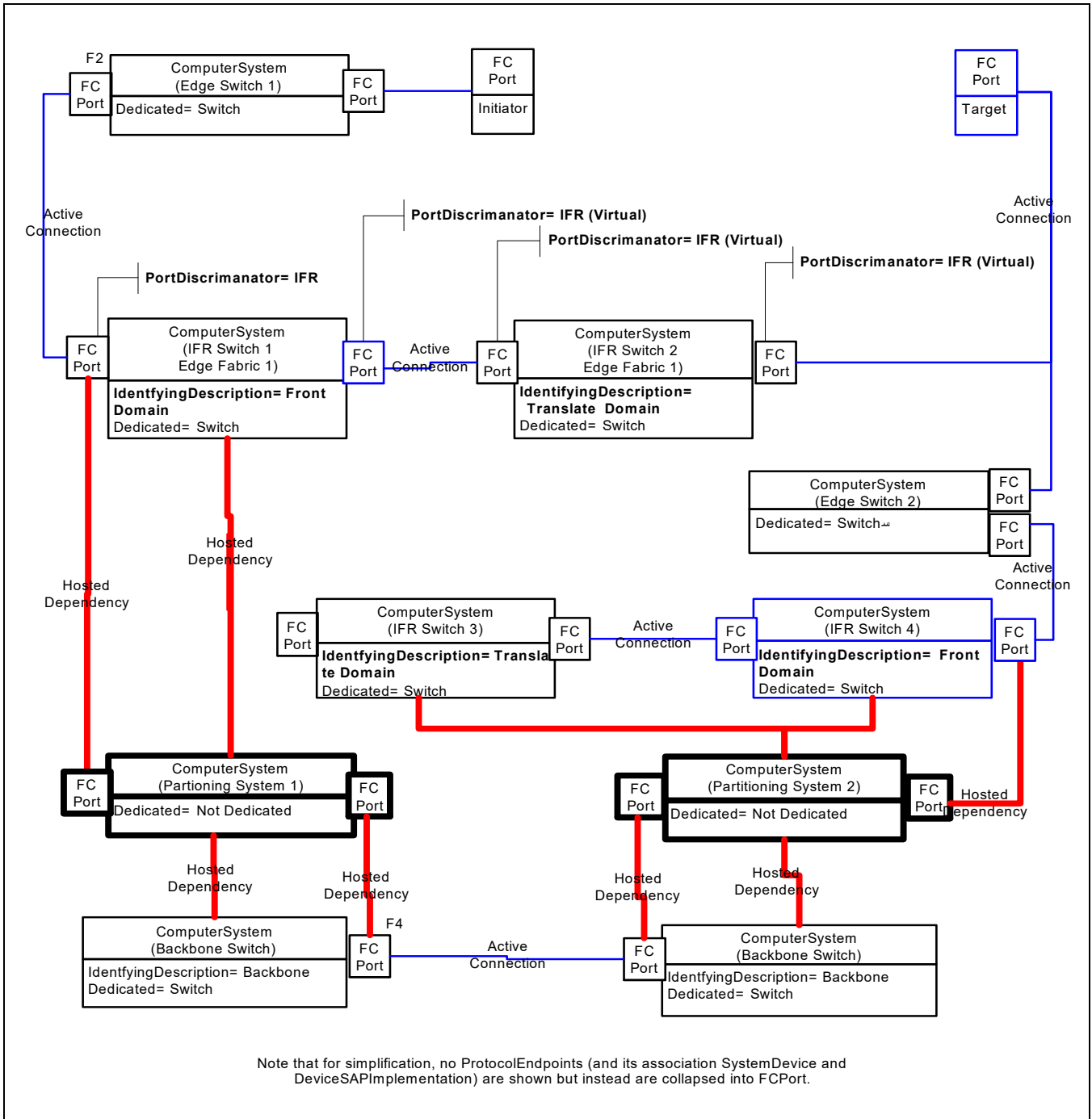

Figure 27 - IFR Switch Topology

There is a fabric, called *backbone*, which provides the mechanism to physically connect the two fabrics, called *edge*, together. In the instance diagram, two edge fabrics (A and B) are connected by a single backbone fabric. The two partitioning switches, Partitioning Switch 1 and 2, make up the backbone fabric and provide the routing between Edge Fabric A and B. These two partitioning switches also physically connect to only one additional switch in Fabric A and B, identified as Edge Switch 1 and 2, respectively. The partitioning switches presents to each edge fabric, two partitioned switches for the front and translate domains. In this example, a device called initiator is physically in Fabric A and another device called

Target is physically in Fabric B, but shared to Fabric A as can be seen by device having an ActiveConnection to two different partitioned switches.

This profile itself does not introduce any new classes. It extends the Fabric Profile. Without the Inter Fabric Routing Profile, a client would see three separate fabrics without any knowledge that they are physically inter-connected and the shared devices appearing in different fabrics might even confuse the user. That is, Partitioning System 1 and 2 and the HostedDependency would not exist and only present Fabric A, B, and Backbone as three separate fabrics through the Fabric Profile.

This profile does require new properties (in bold). Specifically it requires that the switches have the property IdentifyingDescription populated with either "Front Domain", the domain that links directly to the Edge Fabric, or "Translate Domain", the domain that links to the shared device.

14.2.3 Identification of Ports

It also requires the PortDiscriminator property on FCPort to be populated on all the ports of the switches with either "IFR" or "IFR (Virtual)". The "IFR (Virtual)" FCPorts are those ports that have no underlying physical manifestation. Specifically, these are the port on, or connected, to the translate domain.

Figure 28 illustrates the usage of PortDiscriminators in modeling of an Inter Fabric Routing.

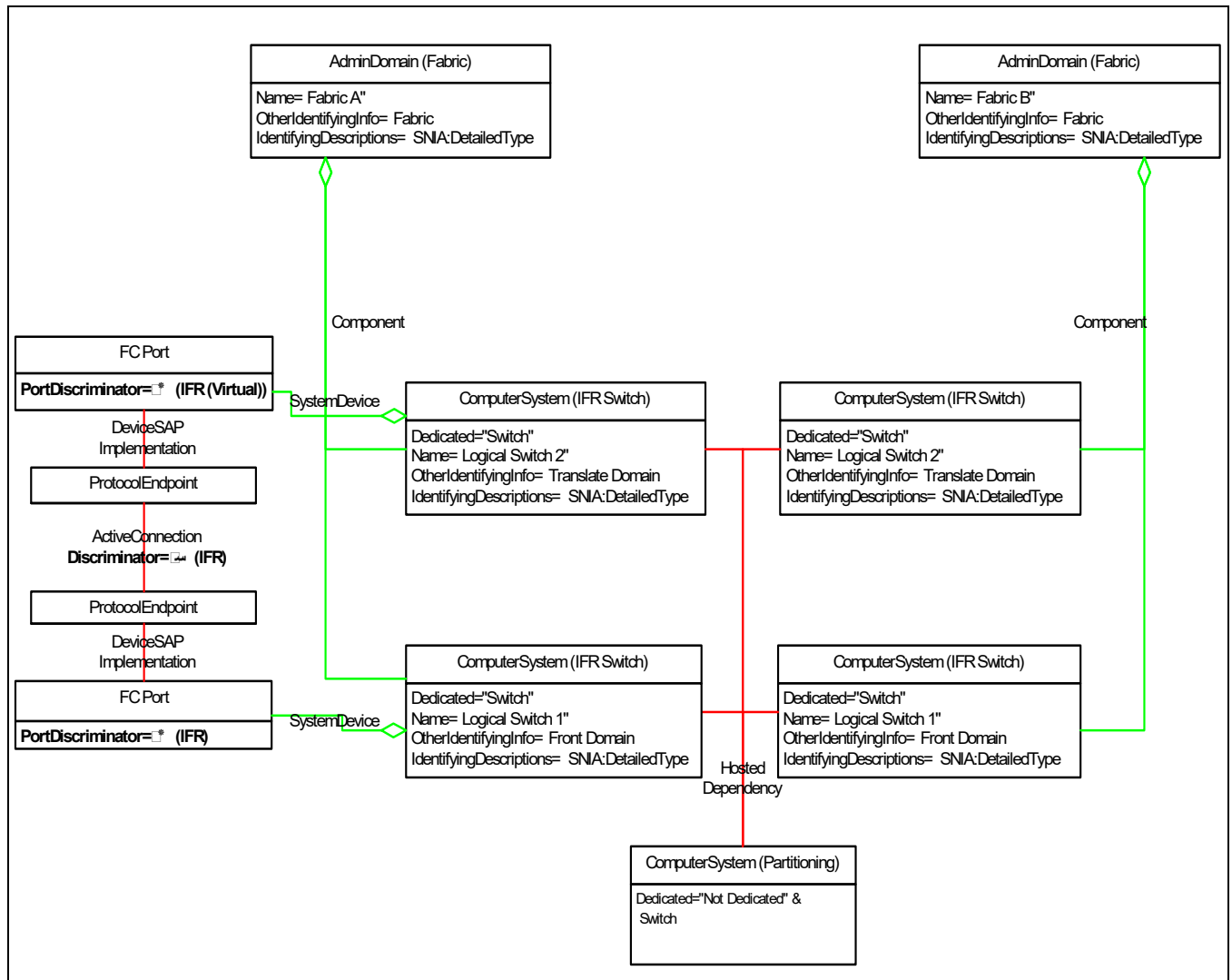

Figure 28 - Inter Fabric Routing Ports

14.3 Health and Fault Management Consideration

Not defined in this document.

14.4 Cascading Considerations

Not defined in this document.

14.5 Methods of the Profile

Not defined in this document.

14.6 Use Cases

Not defined in this document.

14.7 CIM Elements

14.7.1 Overview

Table 161 describes the CIM elements for Inter Fabric Routing.

Table 161 - CIM Elements for Inter Fabric Routing

Element Name	Requirement	Description
14.7.2 CIM_Component (Backbone Switch to Fabric)	Mandatory	Aggregates Backbone Switches in the AdminDomain that represents an interconnect Fabric.
14.7.3 CIM_Component (IFR Switch to Fabric)	Mandatory	Aggregates IFR Switches in the AdminDomain that represents a connected Fabric.
14.7.4 CIM_ComputerSystem (Backbone Switch)	Mandatory	This is a special case of a switch (one used to interconnect fabrics).
14.7.5 CIM_ComputerSystem (IFR Switch)	Mandatory	This is an IFR special case of a Switch ComputerSystem.
14.7.6 CIM_FCActiveConnection	Optional	The association between ProtocolEndpoints representing the links between fibre channel devices (including ISLs).
14.7.7 CIM_FCPort (IFR FCPort)	Mandatory	Fibre Channel Port for an IFR Switch.
14.7.8 CIM_ProtocolEndpoint	Mandatory	The endpoint of a link (ActiveConnection).
14.7.9 CIM_SystemDevice	Mandatory	Associates an IFR FCPort to IFR Switch (ComputerSystem)

14.7.2 CIM_Component (Backbone Switch to Fabric)

Aggregates Backbone Switches in the AdminDomain that represents an interconnected Fabric.

Created By: Static

Modified By: Static

Deleted By: Static

Requirement: Mandatory

Table 162 describes class CIM_Component (Backbone Switch to Fabric).

Table 162 - SMI Referenced Properties/Methods for CIM_Component (Backbone Switch to Fabric)

Properties	Flags	Requirement	Description & Notes
PartComponent		Mandatory	Reference to a Backbone Switch.
GroupComponent		Mandatory	Reference to the AdminDomain representing the Fabric (OtherIdentifyingInfo contains 'Fabric' with a corresponding 'SNIA:DetailedType' in IdentifyingDescriptions').

14.7.3 CIM_Component (IFR Switch to Fabric)

Aggregates IFR Switches in the AdminDomain that represents a connected Fabric.

Created By: Static

Modified By: Static

Deleted By: Static

Requirement: Mandatory

Table 163 describes class CIM_Component (IFR Switch to Fabric).

Table 163 - SMI Referenced Properties/Methods for CIM_Component (IFR Switch to Fabric)

Properties	Flags	Requirement	Description & Notes
PartComponent		Mandatory	Reference to an IFR Switch.
GroupComponent		Mandatory	Reference to the AdminDomain representing the Fabric (OtherIdentifyingInfo contains 'Fabric' with a corresponding 'SNIA:DetailedType' in IdentifyingDescriptions').

14.7.4 CIM_ComputerSystem (Backbone Switch)

In the Inter Fabric Routing profile, this is ComputerSystem representing switches for interconnecting fabrics.

Created By: External

Modified By: Static

Deleted By: External

Requirement: Mandatory

Table 164 describes class CIM_ComputerSystem (Backbone Switch).

Table 164 - SMI Referenced Properties/Methods for CIM_ComputerSystem (Backbone Switch)

Properties	Flags	Requirement	Description & Notes
CreationClassName		Mandatory	See the CreationClassName definition in section <i>Storage Management Technical Specification, Part 6 Fabric, 1.8.0 Rev 4 4.7.10</i> CIM_ComputerSystem (Switch).
Name	C	Mandatory	See the Name definition in section <i>Storage Management Technical Specification, Part 6 Fabric, 1.8.0 Rev 4 4.7.10</i> CIM_ComputerSystem (Switch).
ElementName		Mandatory	See the ElementName definition in section <i>Storage Management Technical Specification, Part 6 Fabric, 1.8.0 Rev 4 4.7.10</i> CIM_ComputerSystem (Switch).
NameFormat		Mandatory	See the NameFormat definition in section <i>Storage Management Technical Specification, Part 6 Fabric, 1.8.0 Rev 4 4.7.10</i> CIM_ComputerSystem (Switch).
OperationalStatus		Mandatory	See the OperationalStatus definition in section <i>Storage Management Technical Specification, Part 6 Fabric, 1.8.0 Rev 4 4.7.10</i> CIM_ComputerSystem (Switch).
Dedicated		Mandatory	See the Dedicated definition in section <i>Storage Management Technical Specification, Part 6 Fabric, 1.8.0 Rev 4 4.7.10</i> CIM_ComputerSystem (Switch).
OtherIdentifyingInfo	C	Mandatory	One of the indices shall contain the value 'Backbone' and in the corresponding index for OtherIdentifyingDescription the value 'SNIA:DetailedType'.
IdentifyingDescriptions		Mandatory	One of the indices shall contain the value 'SNIA:DetailedType' and in the corresponding index for OtherIdentifyingInfo a value of 'Backbone' for an Inter-Fabric Routing (IFR) switch for interconnecting fabrics.

Table 164 - SMI Referenced Properties/Methods for CIM_ComputerSystem (Backbone Switch)

Properties	Flags	Requirement	Description & Notes
EnabledState		Mandatory	See the EnabledState definition in section <i>Storage Management Technical Specification, Part 6 Fabric, 1.8.0 Rev 4 4.7.10</i> CIM_ComputerSystem (Switch).
RequestedState		Conditional	Conditional requirement: Required if the Switch profile is implemented. See the RequestedState definition in section <i>Storage Management Technical Specification, Part 6 Fabric, 1.8.0 Rev 4 10.7.3</i> CIM_ComputerSystem (Switch).
EnabledDefault		Optional	See the EnabledDefault definition in section <i>Storage Management Technical Specification, Part 6 Fabric, 1.8.0 Rev 4 10.7.3</i> CIM_ComputerSystem (Switch).
RequestStateChange()		Conditional	Conditional requirement: Required if the Switch profile is implemented. See the RequestStateChange definition in section <i>Storage Management Technical Specification, Part 6 Fabric, 1.8.0 Rev 4 10.7.3</i> CIM_ComputerSystem (Switch).

14.7.5 CIM_ComputerSystem (IFR Switch)

In the Inter Fabric Routing profile, this is ComputerSystem representing switches.

Created By: External

Modified By: Static

Deleted By: External

Requirement: Mandatory

Table 165 describes class CIM_ComputerSystem (IFR Switch).

Table 165 - SMI Referenced Properties/Methods for CIM_ComputerSystem (IFR Switch)

Properties	Flags	Requirement	Description & Notes
CreationClassName		Mandatory	See the CreationClassName definition in section <i>Storage Management Technical Specification, Part 6 Fabric, 1.8.0 Rev 4 4.7.10</i> CIM_ComputerSystem (Switch).
Name	C	Mandatory	See the Name definition in section <i>Storage Management Technical Specification, Part 6 Fabric, 1.8.0 Rev 4 4.7.10</i> CIM_ComputerSystem (Switch).
ElementName		Mandatory	See the ElementName definition in section <i>Storage Management Technical Specification, Part 6 Fabric, 1.8.0 Rev 4 4.7.10</i> CIM_ComputerSystem (Switch).
NameFormat		Mandatory	See the NameFormat definition in section <i>Storage Management Technical Specification, Part 6 Fabric, 1.8.0 Rev 4 4.7.10</i> CIM_ComputerSystem (Switch).
OperationalStatus		Mandatory	See the OperationalStatus definition in section <i>Storage Management Technical Specification, Part 6 Fabric, 1.8.0 Rev 4 4.7.10</i> CIM_ComputerSystem (Switch).
Dedicated		Mandatory	See the Dedicated definition in section <i>Storage Management Technical Specification, Part 6 Fabric, 1.8.0 Rev 4 4.7.10</i> CIM_ComputerSystem (Switch).

Table 165 - SMI Referenced Properties/Methods for CIM_ComputerSystem (IFR Switch)

Properties	Flags	Requirement	Description & Notes
OtherIdentifyingInfo	C	Mandatory	One of the indices shall contain the value 'Front Domain' or 'Translate Domain' and in the corresponding index for OtherIdentifyingDescription the value 'SNIA:DetailedType'.
IdentifyingDescriptions		Mandatory	One of the indices shall contain the value 'SNIA:DetailedType' and in the corresponding index for OtherIdentifyingInfo a value of 'Front Domain' for an Inter-Fabric Routing (IFR) Front Domain or 'Translate Domain' for an Inter-Fabric Routing (IFR) Translate Domain.
EnabledState		Mandatory	See the EnabledState definition in section <i>Storage Management Technical Specification, Part 6 Fabric, 1.8.0 Rev 4 4.7.10 CIM_ComputerSystem (Switch)</i> .
RequestedState		Conditional	Conditional requirement: Required if the Switch profile is implemented. See the RequestedState definition in section <i>Storage Management Technical Specification, Part 6 Fabric, 1.8.0 Rev 4 10.7.3 CIM_ComputerSystem (Switch)</i> .
EnabledDefault		Optional	See the EnabledDefault definition in section <i>Storage Management Technical Specification, Part 6 Fabric, 1.8.0 Rev 4 10.7.3 CIM_ComputerSystem (Switch)</i> .
RequestStateChange()		Conditional	Conditional requirement: Required if the Switch profile is implemented. See the RequestStateChange definition in section <i>Storage Management Technical Specification, Part 6 Fabric, 1.8.0 Rev 4 10.7.3 CIM_ComputerSystem (Switch)</i> .

14.7.6 CIM_FCActiveConnection

The association between ProtocolEndpoints representing the links between fibre channel devices (including ISLs). For loops and NPIV, multiple ActiveConnections are instantiated as one to many relationships.

Created By: Static

Modified By: Static

Deleted By: Static

Requirement: Optional

Table 166 describes class CIM_FCActiveConnection.

Table 166 - SMI Referenced Properties/Methods for CIM_FCActiveConnection

Properties	Flags	Requirement	Description & Notes
Discriminator		Mandatory	An array property enumeration used to discriminate the context in which the ActiveConnection is instantiated. For ActiveConnections between IFR Ports this property shall contain the value '6' (IFR).
Antecedent		Mandatory	The reference to the ProtocolEndpoint for one end of the link.
Dependent		Mandatory	The reference to the ProtocolEndpoint for the other end of the link.

14.7.7 CIM_FCPort (IFR FCPort)

Fibre Channel Port for an IFR Switch.

Created By: Static
 Modified By: Static
 Deleted By: Static
 Requirement: Mandatory

Table 167 describes class CIM_FCPort (IFR FCPort).

Table 167 - SMI Referenced Properties/Methods for CIM_FCPort (IFR FCPort)

Properties	Flags	Requirement	Description & Notes
SystemCreationClassName		Mandatory	See the SystemCreationClassName definition in section <i>Storage Management Technical Specification, Part 6 Fabric, 1.8.0 Rev 4 4.7.23 CIM_FCPort (Switch FCPort)</i> .
SystemName		Mandatory	See the SystemName definition in section <i>Storage Management Technical Specification, Part 6 Fabric, 1.8.0 Rev 4 4.7.23 CIM_FCPort (Switch FCPort)</i> .
CreationClassName		Mandatory	See the CreationClassName definition in section <i>Storage Management Technical Specification, Part 6 Fabric, 1.8.0 Rev 4 4.7.23 CIM_FCPort (Switch FCPort)</i> .
DeviceID		Mandatory	See the DeviceID definition in section <i>Storage Management Technical Specification, Part 6 Fabric, 1.8.0 Rev 4 4.7.23 CIM_FCPort (Switch FCPort)</i> .
ElementName		Mandatory	See the ElementName definition in section <i>Storage Management Technical Specification, Part 6 Fabric, 1.8.0 Rev 4 4.7.23 CIM_FCPort (Switch FCPort)</i> .
PermanentAddress	CD	Mandatory	Fibre Channel Port WWN.
Speed		Optional	See the Speed definition in section <i>Storage Management Technical Specification, Part 6 Fabric, 1.8.0 Rev 4 10.7.12 CIM_FCPort (Switch FCPort)</i> .
OperationalStatus		Mandatory	See the OperationalStatus definition in section <i>Storage Management Technical Specification, Part 6 Fabric, 1.8.0 Rev 4 4.7.23 CIM_FCPort (Switch FCPort)</i> .
PortType		Mandatory	See the PortType definition in section <i>Storage Management Technical Specification, Part 6 Fabric, 1.8.0 Rev 4 4.7.23 CIM_FCPort (Switch FCPort)</i> .
LinkTechnology		Mandatory	See the LinkTechnology definition in section <i>Storage Management Technical Specification, Part 6 Fabric, 1.8.0 Rev 4 4.7.23 CIM_FCPort (Switch FCPort)</i> .
EnabledState		Mandatory	See the EnabledState definition in section <i>Storage Management Technical Specification, Part 6 Fabric, 1.8.0 Rev 4 4.7.23 CIM_FCPort (Switch FCPort)</i> .
DetailedPortState		Conditional	Conditional requirement: Required if the Switch profile is implemented. See <i>Storage Management Technical Specification, Part 6 Fabric, 1.8.0 Rev 4 Table 94 - DetailedPortState for FCPort</i> .
PortAvailability		Optional	See <i>Storage Management Technical Specification, Part 6 Fabric, 1.8.0 Rev 4 Table 95 - PortAvailability for FCPort</i> .
RequestedState		Conditional	Conditional requirement: Required if the Switch profile is implemented. See the RequestedState definition in section <i>Storage Management Technical Specification, Part 6 Fabric, 1.8.0 Rev 4 10.7.12 CIM_FCPort (Switch FCPort)</i> .

Table 167 - SMI Referenced Properties/Methods for CIM_FCPort (IFR FCPort)

Properties	Flags	Requirement	Description & Notes
EnabledDefault		Conditional	Conditional requirement: Required if the Switch profile is implemented. See the EnabledDefault definition in section <i>Storage Management Technical Specification, Part 6 Fabric, 1.8.0 Rev 4</i> 10.7.12 CIM_FCPort (Switch FCPort).
MaxSpeed		Conditional	Conditional requirement: Required if the Switch profile is implemented. See the MaxSpeed definition in section <i>Storage Management Technical Specification, Part 6 Fabric, 1.8.0 Rev 4</i> 10.7.12 CIM_FCPort (Switch FCPort).
PortNumber		Conditional	Conditional requirement: Required if the Switch profile is implemented. See the PortNumber definition in section <i>Storage Management Technical Specification, Part 6 Fabric, 1.8.0 Rev 4</i> 10.7.12 CIM_FCPort (Switch FCPort).
PortDiscriminator		Mandatory	Ports that participate in IFR shall contain the value '5' [IFR] or '6' [IFR (Virtual)].
RequestStateChange()		Conditional	Conditional requirement: Support for the Switch Profile and a non-null value in FCPortCapabilities.RequestedStatesSupported. See the RequestStateChange definition in section <i>Storage Management Technical Specification, Part 6 Fabric, 1.8.0 Rev 4</i> 10.7.12 CIM_FCPort (Switch FCPort).

14.7.8 CIM_ProtocolEndpoint

The endpoint of a link (ActiveConnection). ProtocolEndpoint shall be implemented when an ActiveConnection exists. It may be implemented if no ActiveConnections exist.

Created By: Static

Modified By: Static

Deleted By: Static

Requirement: Mandatory

Table 168 describes class CIM_ProtocolEndpoint.

Table 168 - SMI Referenced Properties/Methods for CIM_ProtocolEndpoint

Properties	Flags	Requirement	Description & Notes
SystemCreationClassName		Mandatory	The scoping System's CreationClassName.
SystemName		Mandatory	The scoping System's Name.
CreationClassName		Mandatory	Name of Class.
Name	CD	Mandatory	The Fibre Channel Port WWN.
NameFormat		Mandatory	'WWN'.
ProtocolIFType		Mandatory	Shall be 56(Fibre channel).

EXPERIMENTAL

14.7.9 CIM_SystemDevice

Created By: Static

Modified By: Static

Deleted By: Static

Requirement: Mandatory

Table 169 describes class CIM_SystemDevice.

Table 169 - SMI Referenced Properties/Methods for CIM_SystemDevice

Properties	Flags	Requirement	Description & Notes
PartComponent		Mandatory	The reference to the switch FCPort..
GroupComponent		Mandatory	The reference to the IFR switch System.

EXPERIMENTAL

15 FCoE Fabric

15.1 Synopsis

Profile Name: FCoE Fabric (Component Profile)

Version: 1.8.0

Organization: SNIA

Central Class: AdminDomain

Scoping Class: AdminDomain

Related Profiles: Not defined in this document

15.2 Description

The FCoE Fabric Profile extends the Fabric Profile to provide the necessary information to identify that the discovered Fibre Channel Fabric is running FCoE and the correlatable Ethernet components. Specifically this profile identifies the Ethernet Switch and Ethernet Ports provided by a FCoE Switch as well as the end devices running FCoE. The added portions of the model for the Ethernet portion.

The Ethernet side, for purposes of this profile, will be called the Ethernet Network and is a mirror image in many ways of the Fibre Channel Fabric profile. For example, it has ConnectivityCollection collecting ProtocolEndpoints in this case LANEndpoints. ComputerSystems having the Dedicated property set to "Ethernet Switch" instead of "FC Switch" which is hosted to the "physical" ComputerSystem (see 15 "FCoE Fabric"). An AdminDomain having components of ComputerSystems being the Ethernet Switches. LANEndpoints associated to EthernetPorts as ProtocolEndpoints associated with FCPorts. Also any of the FCPorts that are hosted on EthernetPorts have the PortDiscriminator property set to "FCoE".

Figure 29 shows the FCoE Fabric instance.

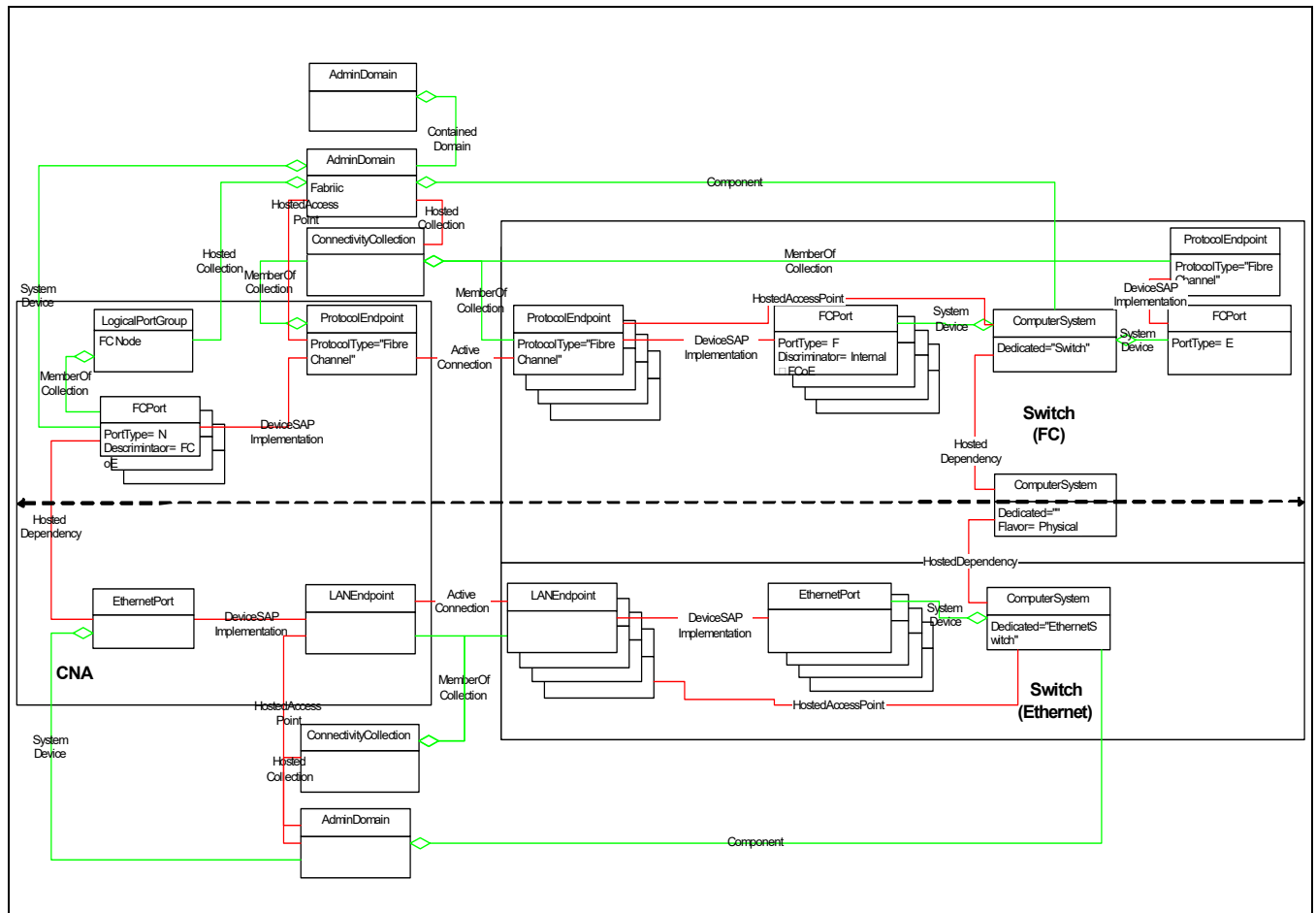

Figure 29 - FCoE Fabric Instance Diagram

15.3 Health and Fault Management Consideration

Not defined in this document

15.4 Methods of the Profile

Not defined in this document

15.5 Use Cases

Not defined in this document.

15.6 CIM Elements

15.6.1 Overview

Table 170 describes the CIM elements for FCoE Fabric.

Table 170 - CIM Elements for FCoE Fabric

Element Name	Requirement	Description
15.6.2 CIM_AdminDomain (Ethernet Network)	Mandatory	AdminDomain representing the Ethernet Network.
15.6.3 CIM_Component (Switch to Ethernet Network)	Mandatory	Aggregates Switches in the AdminDomain that represents the Ethernet Fabric.
15.6.4 CIM_ComputerSystem (Ethernet Switch)	Mandatory	The ComputerSystem representing an Ethernet Switch.
15.6.5 CIM_ConnectivityCollection (LANEndpoints to EthernetNetwork)	Mandatory	Collects the LanEndpoints of the Ethernet Network.
15.6.6 CIM_DeviceSAPImplementation (Ethernet Switch EthernetPort to LANEndpoint)	Mandatory	Associates the Switch EthernetPort to the LANEndpoint.
15.6.7 CIM_DeviceSAPImplementation (Non-Switch EthernetPort to LANEndpoint)	Mandatory	Associates the Non-Switch (Host or Storage) EthernetPort to the LANEndpoint.
15.6.8 CIM_ActiveConnection (Links transported over Ethernet (FCoE))	Mandatory	The association between ProtocolEndpoints representing the links between fibre channel devices (including ISLs).
15.6.9 CIM_EthernetPort (Host EthernetPort))	Mandatory	
15.6.10 CIM_EthernetPort (Storage EthernetPort)	Mandatory	
15.6.11 CIM_EthernetPort (Switch EthernetPort)	Mandatory	
15.6.12 CIM_HostedAccessPoint (AdminDomain to LANEndpoint)	Mandatory	Associates the LANEndpoint to an Ethernet Fabric AdminDomain.
15.6.13 CIM_HostedAccessPoint (ComputerSystem to LANEndpoint)	Mandatory	Associates the LANEndpoint to the hosting Ethernet Switch ComputerSystem.
15.6.14 CIM_HostedCollection (Ethernet Network AdminDomain to ConnectivityCollection)	Mandatory	Associates the ConnectivityCollection of LANEndpoints to the AdminDomain representing the Ethernet Network.
15.6.15 CIM_HostedDependency (ComputerSystem (Ethernet Switch) to Partitioning ComputerSystem)	Optional	The association representing the relationship of the ComputerSystem (Ethernet Switch) that hosts the ComputerSystems (FC Switches) that are virtualized.
15.6.16 CIM_HostedDependency (FCPort to EthernetPort)	Optional	The association representing the relationship of the EthernetPort that hosts the FCPorts for FCoE.
15.6.17 CIM_LANEndpoint (Ethernet ProtocolEndpoint)	Mandatory	The endpoint of a link (ActiveConnection).
15.6.18 CIM_MemberOfCollection (ConnectivityCollection to LANEndpoint)	Mandatory	Associates ConnectivityCollection to LANEndpoint.
15.6.19 CIM_SystemDevice (Switch EthernetPort to Switch)	Mandatory	Associates Switch EthernetPorts to the ComputerSystem (Switch).
15.6.20 CIM_SystemDevice (non-Switch EthernetPort to Ethernet AdminDomain)	Mandatory	Associates non-Switch EthernetPorts to the Ethernet AdminDomain.

15.6.2 CIM_AdminDomain (Ethernet Network)

AdminDomain representing the Ethernet Network.

Created By: Static

Modified By: Static

Deleted By: Static

Requirement: Mandatory

Table 171 describes class CIM_AdminDomain (Ethernet Network).

Table 171 - SMI Referenced Properties/Methods for CIM_AdminDomain (Ethernet Network)

Properties	Flags	Requirement	Description & Notes
CreationClassName		Mandatory	Name of Class.
Name		Mandatory	An arbitrary name (implementation dependent).
NameFormat		Mandatory	Dependent on the arbitrary name chosen.
ElementName		Optional	A user friendly name for the Ethernet Network (implementation dependent).
OtherIdentifyingInfo		Mandatory	For an Ethernet Network AdminDomain this property shall contain the value 'Ethernet'.
IdentifyingDescriptions		Mandatory	For a SAN AdminDomain this property shall contain the value 'SNIA:DetailedType' in the index for the OtherIdentifyingInfo of 'Ethernet'.

15.6.3 CIM_Component (Switch to Ethernet Network)

Aggregates Switches in the AdminDomain that comprise the Ethernet Fabric.

Created By: Static

Modified By: Static

Deleted By: Static

Requirement: Mandatory

Table 172 describes class CIM_Component (Switch to Ethernet Network).

Table 172 - SMI Referenced Properties/Methods for CIM_Component (Switch to Ethernet Network)

Properties	Flags	Requirement	Description & Notes
PartComponent		Mandatory	Reference to an Ethernet Switch.
GroupComponent		Mandatory	Reference to the AdminDomain representing the Ethernet Network (OtherIdentifyingInfo contains 'Ethernet' with a corresponding 'SNIA:DetailedType' in IdentifyingDescriptions).

15.6.4 CIM_ComputerSystem (Ethernet Switch)

The ComputerSystem representing an Ethernet Switch. This is a constrained case of the Switch ComputerSystem.

Created By: Static

Modified By: Static

Deleted By: Static
Requirement: Mandatory

Table 173 describes class CIM_ComputerSystem (Ethernet Switch).

Table 173 - SMI Referenced Properties/Methods for CIM_ComputerSystem (Ethernet Switch)

Properties	Flags	Requirement	Description & Notes
CreationClassName		Mandatory	See the CreationClassName definition in section 4.7.10 CIM_ComputerSystem (Switch).
Name	C	Mandatory	The Name serves as the key of a System instance in an enterprise environment.
ElementName		Mandatory	See the ElementName definition in section 4.7.10 CIM_ComputerSystem (Switch).
NameFormat		Mandatory	The format of the Name property.
OperationalStatus		Mandatory	See the OperationalStatus definition in section 4.7.10 CIM_ComputerSystem (Switch).
Dedicated		Mandatory	Shall be 38 (Ethernet Switch).
EnabledState		Mandatory	See the EnabledState definition in section 4.7.10 CIM_ComputerSystem (Switch).

15.6.5 CIM_ConnectivityCollection (LANEndpoints to EthernetNetwork)

Collects the ProtocolEndpoints of the fabric.

Created By: Static
Modified By: Static
Deleted By: Static
Requirement: Mandatory

Table 174 describes class CIM_ConnectivityCollection (LANEndpoints to EthernetNetwork).

Table 174 - SMI Referenced Properties/Methods for CIM_ConnectivityCollection (LANEndpoints to EthernetNetwork)

Properties	Flags	Requirement	Description & Notes
InstanceID		Mandatory	Opaque.
ElementName		Optional	Not required, can be the Fabric WWN.

15.6.6 CIM_DeviceSAPImplementation (Ethernet Switch EthernetPort to LANEndpoint)

Associates the Ethernet Switch EthernetPort to the LANEndpoint.

Created By: Static
Modified By: Static
Deleted By: Static
Requirement: Mandatory

Table 175 describes class CIM_DeviceSAPImplementation (Ethernet Switch EthernetPort to LANEndpoint).

Table 175 - SMI Referenced Properties/Methods for CIM_DeviceSAPImplementation (Ethernet Switch EthernetPort to LANEndpoint)

Properties	Flags	Requirement	Description & Notes
Dependent		Mandatory	Reference to the LANEndpoint.
Antecedent		Mandatory	Reference to the Ethernet Switch EthernetPort.

15.6.7 CIM_DeviceSAPImplementation (Non-Switch EthernetPort to LANEndpoint)

Associates the Non-Switch (Host or Storage) EthernetPort to the LANEndpoint.

Created By: Static
 Modified By: Static
 Deleted By: Static
 Requirement: Mandatory

Table 176 describes class CIM_DeviceSAPImplementation (Non-Switch EthernetPort to LANEndpoint).

Table 176 - SMI Referenced Properties/Methods for CIM_DeviceSAPImplementation (Non-Switch Ethernet-Port to LANEndpoint)

Properties	Flags	Requirement	Description & Notes
Dependent		Mandatory	Reference to the LANEndpoint.
Antecedent		Mandatory	Reference to the Non-Switch EthernetPort.

15.6.8 CIM_ActiveConnection (Links transported over Ethernet (FCoE))

The association between ProtocolEndpoints representing the links between fibre channel devices (including ISLs). For loops and NPIV, multiple ActiveConnections are instantiated as one to many relationships.

Created By: Static
 Modified By: Static
 Deleted By: Static
 Requirement: Mandatory

Table 177 describes class CIM_ActiveConnection (Links transported over Ethernet (FCoE)).

Table 177 - SMI Referenced Properties/Methods for CIM_ActiveConnection (Links transported over Ethernet (FCoE))

Properties	Flags	Requirement	Description & Notes
Antecedent		Mandatory	The reference to the ProtocolEndpoint for one end of the link.
Dependent		Mandatory	The reference to the ProtocolEndpoint for the other end of the link.

15.6.9 CIM_EthernetPort (Host EthernetPort)

Created By: Static

Modified By: Static
 Deleted By: Static
 Requirement: Mandatory

Table 178 describes class CIM_EthernetPort (Host EthernetPort)..

Table 178 - SMI Referenced Properties/Methods for CIM_EthernetPort (Host EthernetPort).

Properties	Flags	Requirement	Description & Notes
SystemCreationClassName		Mandatory	
SystemName		Mandatory	
CreationClassName		Mandatory	
DeviceID		Mandatory	
LinkTechnology		Mandatory	Shall be 2 ('Ethernet').
OperationalStatus		Mandatory	Shall be 0 (Unknown), 2 (OK), 6 (Error), 10 (Stopped), or 11 (In Service)
PermanentAddress	CD	Mandatory	The MAC Address. Shall be formatted as 12 un-separated upper case hex digits.

15.6.10 CIM_EthernetPort (Storage EthernetPort)

Created By: Static
 Modified By: Static
 Deleted By: Static
 Requirement: Mandatory.

Table 179 describes class CIM_EthernetPort (Storage EthernetPort).

Table 179 - SMI Referenced Properties/Methods for CIM_EthernetPort (Storage EthernetPort)

Properties	Flags	Requirement	Description & Notes
SystemCreationClassName		Mandatory	
SystemName		Mandatory	
CreationClassName		Mandatory	
DeviceID		Mandatory	
LinkTechnology		Mandatory	Shall be 2 (Ethernet).
OperationalStatus		Mandatory	Shall be 0 (Unknown), 2 (OK), 6 (Error), 10 (Stopped), or 11 (In Service).
PermanentAddress	CD	Mandatory	The MAC Address. Shall be formatted as 12 un-separated upper case hex digits.

15.6.11 CIM_EthernetPort (Switch EthernetPort)

Created By: Static
 Modified By: Static
 Deleted By: Static
 Requirement: Mandatory.

Table 180 describes class CIM_EthernetPort (Switch EthernetPort).

Table 180 - SMI Referenced Properties/Methods for CIM_EthernetPort (Switch EthernetPort)

Properties	Flags	Requirement	Description & Notes
SystemCreationClassName		Mandatory	
SystemName		Mandatory	
CreationClassName		Mandatory	
DeviceID		Mandatory	
LinkTechnology		Mandatory	Shall be 2 (Ethernet).
OperationalStatus		Mandatory	Shall be 0 (Unknown), 2 (OK), 6 (Error), 10 (Stopped), or 11 (In Service).
PermanentAddress	CD	Mandatory	The MAC Address. Shall be formatted as 12 un-separated upper case hex digits.

15.6.12 CIM_HostedAccessPoint (AdminDomain to LANEndpoint)

Associates the LANEndpoint to the Ethernet Fabric AdminDomain for those systems not registered in the Platform Database or discovered through FDMI.

Created By: Static
 Modified By: Static
 Deleted By: Static
 Requirement: Mandatory

Table 181 describes class CIM_HostedAccessPoint (AdminDomain to LANEndpoint).

Table 181 - SMI Referenced Properties/Methods for CIM_HostedAccessPoint (AdminDomain to LANEndpoint)

Properties	Flags	Requirement	Description & Notes
Dependent		Mandatory	Reference to the LANEndpoint.
Antecedent		Mandatory	Reference to the Fabric AdminDomain (OtherIdentifyingInfo contains 'Fabric' with a corresponding 'SNIA:DetailedType' in IdentifyingDescriptions).

15.6.13 CIM_HostedAccessPoint (ComputerSystem to LANEndpoint)

Associates the LANEndpoint to the hosting System. The hosting System is a ComputerSystem for the Switch or Platform.

Created By: Static
 Modified By: Static

Deleted By: Static
Requirement: Mandatory

Table 182 describes class CIM_HostedAccessPoint (ComputerSystem to LANEndpoint).

Table 182 - SMI Referenced Properties/Methods for CIM_HostedAccessPoint (ComputerSystem to LANEndpoint)

Properties	Flags	Requirement	Description & Notes
Dependent		Mandatory	Reference to the LANEndpoint.
Antecedent		Mandatory	Reference to the Ethernet Switch.

15.6.14 CIM_HostedCollection (Ethernet Network AdminDomain to ConnectivityCollection)

Associates the ConnectivityCollection to the AdminDomain representing the Fabric.

Created By: Static
Modified By: Static
Deleted By: Static
Requirement: Mandatory

Table 183 describes class CIM_HostedCollection (Ethernet Network AdminDomain to ConnectivityCollection).

Table 183 - SMI Referenced Properties/Methods for CIM_HostedCollection (Ethernet Network AdminDomain to ConnectivityCollection)

Properties	Flags	Requirement	Description & Notes
Dependent		Mandatory	Reference to the ConnectivityCollection.
Antecedent		Mandatory	Reference to the Ethernet Network AdminDomain (OtherIdentifyingInfo contains 'Ethernet' with a corresponding 'SNIA:DetailedType' in IdentifyingDescriptions).

15.6.15 CIM_HostedDependency (ComputerSystem (Ethernet Switch) to Partitioning ComputerSystem)

The association representing the relationship of the ComputerSystem (Ethernet Switch) that hosts the ComputerSystems (FC Switches) that are virtualized.

Created By: Static
Modified By: Static
Deleted By: Static
Requirement: Optional

Table 184 describes class CIM_HostedDependency (ComputerSystem (Ethernet Switch) to Partitioning ComputerSystem).

Table 184 - SMI Referenced Properties/Methods for CIM_HostedDependency (ComputerSystem (Ethernet Switch) to Partitioning ComputerSystem)

Properties	Flags	Requirement	Description & Notes
Antecedent		Mandatory	A reference to the hosting Host ComputerSystem ('physical Ethernet switch').
Dependent		Mandatory	A reference to the hosted fibre channel switch (a ComputerSystem with Dedicated='5').

15.6.16 CIM_HostedDependency (FCPort to EthernetPort)

The association representing the relationship of the EthernetPort that hosts the FCPorts for FCoE. This association is required for all FCPorts at the Hosts that are instantiated as part of FCoE.

Created By: Static
 Modified By: Static
 Deleted By: Static
 Requirement: Optional

Table 185 describes class CIM_HostedDependency (FCPort to EthernetPort).

Table 185 - SMI Referenced Properties/Methods for CIM_HostedDependency (FCPort to EthernetPort)

Properties	Flags	Requirement	Description & Notes
Antecedent		Mandatory	A reference to the hosting Host EthernetPort ("physical").
Dependent		Mandatory	A reference to the hosted FCPort for FCoE (virtualized fibre channel port with PortDiscriminator='10').

15.6.17 CIM_LANEndpoint (Ethernet ProtocolEndpoint)

The endpoint of an ethernet link.

Created By: Static
 Modified By: Static
 Deleted By: Static
 Requirement: Mandatory

Table 186 describes class CIM_LANEndpoint (Ethernet ProtocolEndpoint).

Table 186 - SMI Referenced Properties/Methods for CIM_LANEndpoint (Ethernet ProtocolEndpoint)

Properties	Flags	Requirement	Description & Notes
SystemCreationClassName		Mandatory	The scoping System's CreationClassName.
SystemName		Mandatory	The scoping System's Name.
CreationClassName		Mandatory	Name of Class.
Name	D	Mandatory	The MACAddress.

Table 186 - SMI Referenced Properties/Methods for CIM_LANEndpoint (Ethernet ProtocolEndpoint)

Properties	Flags	Requirement	Description & Notes
NameFormat		Mandatory	'MACAddress'.
ProtocollFType		Mandatory	Shall be 6(Ethernet).

15.6.18 CIM_MemberOfCollection (ConnectivityCollection to LANEndpoint)

Created By: Static

Modified By: Static

Deleted By: Static

Requirement: Mandatory

Table 187 describes class CIM_MemberOfCollection (ConnectivityCollection to LANEndpoint).

Table 187 - SMI Referenced Properties/Methods for CIM_MemberOfCollection (ConnectivityCollection to LANEndpoint)

Properties	Flags	Requirement	Description & Notes
Collection		Mandatory	Reference to the ConnectivityCollection.
Member		Mandatory	Reference to the LANEndpoint.

15.6.19 CIM_SystemDevice (Switch EthernetPort to Switch)

Associates the Switch EthernetPort to the ComputerSystem (Switch).

Created By: Static

Modified By: Static

Deleted By: Static

Requirement: Mandatory

Table 188 describes class CIM_SystemDevice (Switch EthernetPort to Switch).

Table 188 - SMI Referenced Properties/Methods for CIM_SystemDevice (Switch EthernetPort to Switch)

Properties	Flags	Requirement	Description & Notes
PartComponent		Mandatory	The reference to the switch EthernetPort.
GroupComponent		Mandatory	The reference to the Switch ComputerSystem.

15.6.20 CIM_SystemDevice (non-Switch EthernetPort to Ethernet AdminDomain)

Associates the non-Switch EthernetPort to the Ethernet AdminDomain..

Created By: Static

Modified By: Static

Deleted By: Static

Requirement: Mandatory

Table 189 describes class CIM_SystemDevice (non-Switch EthernetPort to EthernetAdminDomain).

Table 189 - SMI Referenced Properties/Methods for CIM_SystemDevice (non-Switch EthernetPort to Ethernet AdminDomain)

Properties	Flags	Requirement	Description & Notes
PartComponent		Mandatory	The reference to a non-switch EthernetPort.
GroupComponent		Mandatory	The reference to the Ethernet AdminDomain.

EXPERIMENTAL

Annex A (informative) SMI-S Information Model

This standard is based on DMTF's CIM schema, Version 2.51. The DMTF schema is available in the machine-readable Managed Object Format (MOF) format. DMTF MOFs are simultaneously released both as an "Experimental" and a "Final" version of the schema. This provides developers with early access to experimental parts of the models. Both versions are available at <http://www.dmtf.org/standards/cim>.

Content marked as "Experimental" or "Implemented" may be based on DMTF's Experimental MOFs.

EXPERIMENTAL

Annex B (Informative) Structure of Fabric Profiles

B.1 Purpose of this Annex

This is an informative annex to the *Storage Management Technical Specification, Part 6 Fabric, 1.8.0 Rev 4* to explain how the main profiles in this part interact. Particular focus is put on the various definitions and usages of CIM_AdminDomain, CIM_ComputerSystem and CIM_FCPort.

B.2 Overview of Fabric Part Profiles

Figure B.1 illustrates the profiles defined in *Storage Management Technical Specification, Part 6 Fabric, 1.8.0 Rev 4* and how they relate.

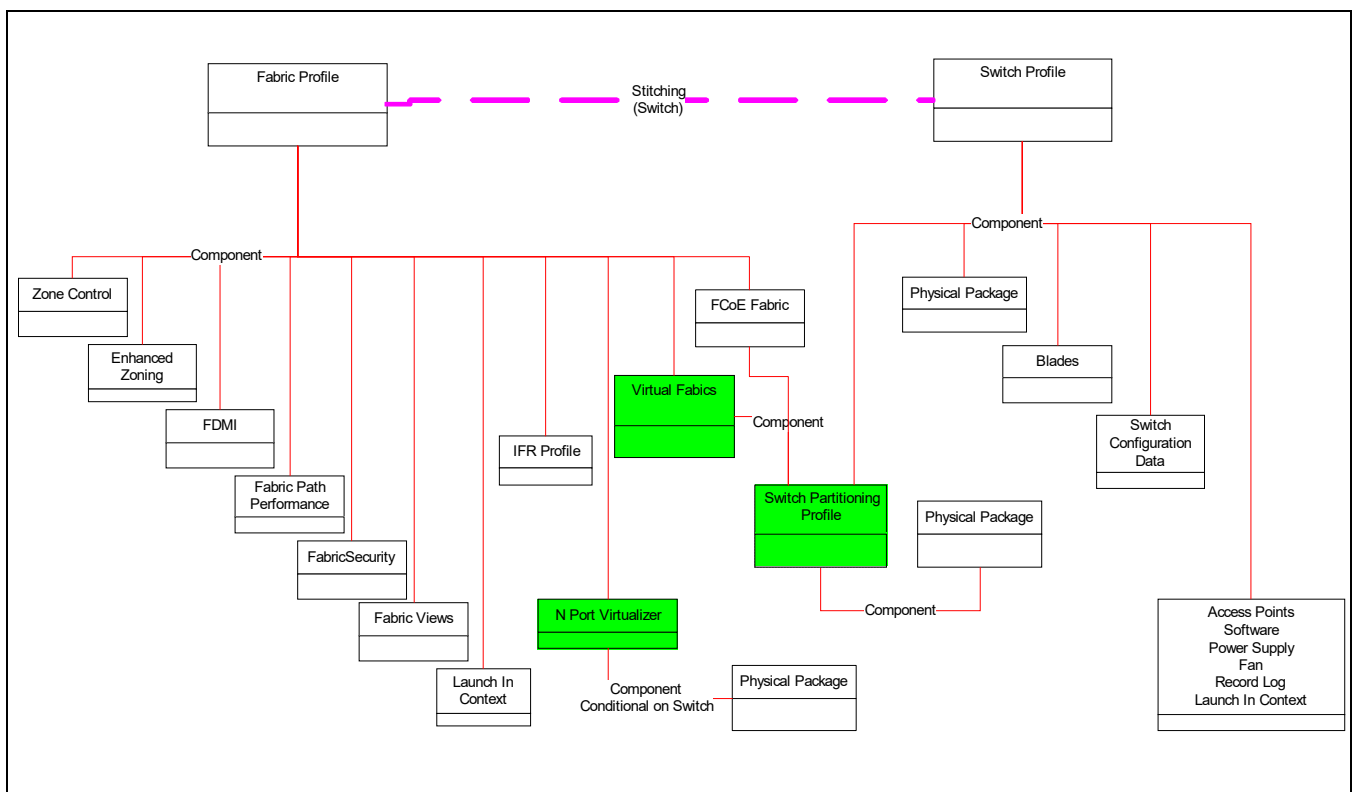

Figure B.1 - The structure of the Fabric Part Profiles

There are two main Autonomous Profiles: the Fabric Profile and the Switch Profile. The other profiles shown are component profiles of either the Fabric or Switch Profiles. In the case of the Switch Partitioning Profile, it may be a component of either the Fabric Profile (when Virtual Fabrics are implemented) or the Switch Profile.

The Fabric Profile (and its component profiles) are distinguished by the existence of instances of the CIM_AdminDomain class. There are two types of CIM_AdminDomain instances. One type represents a Fabric and the other represents a SAN.

Both the Fabric and Switch Profiles reference various types of Switches (represented by CIM_ComputerSystem) and other types of CIM_ComputerSystem instances. Between the two profiles, nine distinct variations of CIM_ComputerSystem are defined. CIM_ComputerSystem is used to represent

a Switch, a Partitioned Switch, an IFR Switch, a Backbone Switch, a Storage Platform, a Host Platform, a Gateway Switch, a "partitioning" system or a "partitioned" system.

An implementation may implement both the Fabric and Switch Profiles. When this is done, the switches in the Fabric Profile will have the same Name property as the switches in the Switch Profile. Some properties are required if the either profile is implemented (e.g., Name, NameFormat and Dedicated), some properties are required if Fabric Profile is implemented and some properties are required if the Switch Profile is implemented.

Like CIM_ComputerSystem, both the Fabric Profile and the Switch Profile make references to instances of CIM_FCPort. There are 9 distinct types of Ports. An instance of an FCPort can be one or more of the a switch FCPort, a partitioned switch FCPort, an IFR FCPort, a Fabric NPIV FCPort, an FCoE FCPort, a Host NPIV Port, a Gateway FCPort or a non-Switch (Platform) FCPort. In addition, a port may also be a NetworkPort attached to a Partitioning System.

To understand which AdminDomain, ComputerSystem or FCPort a particular instance is, a client would inspect certain properties of these classes. In some cases, it will be necessary to also inspect associations on the instance to determine which type of instance it is.

For AdminDomain, the distinguishing properties are OtherIdentifyingInfo and IdentifyingDescriptions. A SAN will have an OtherIdentifyingInfo="SAN" with a corresponding IdentifyingDescription="SNIA:DetailedType". A fabric will have an OtherIdentifyingInfo="Fabric" with a corresponding IdentifyingDescription="SNIA:DetailedType". All instances of fibre channel AdminDomain shall have one of these two values. Furthermore, an instance of AdminDomain shall not specify both "SAN" and "Fabric" in their OtherIdentifyingInfo values (with a corresponding IdentifyingDescription="SNIA:DetailedType"). In addition, if FCoE is implemented there will be another AdminDomain for the Ethernet network. That AdminDomain shall have OtherIdentifyingInfo="Ethernet" with a corresponding IdentifyingDescription="SNA:DetailedType".

For ComputerSystem, the distinguishing properties are Dedicated, OtherIdentifyingInfo and IdentifyingDescriptions. The Fabric Profile defines 4 types of CIM_ComputerSystem instances: A Switch, a Partitioned Switch, a Storage Platform and a Host Platform. In addition, the IFR component profile of the Fabric defines an IFR Switch CIM_ComputerSystem and the N Port Virtualizer defines an N Port Virtualizer CIM_ComputerSystem. In addition, if the Virtual Fabrics Profile is implemented, this profile introduces a "partitioning" CIM_ComputerSystem. In the case of an FCoE environment, the partitioning CIM_ComputerSystem represents an Ethernet Switch. So, a complete implementation of the Fabric Profile (and its component profiles) results in 8 different types of CIM_ComputerSystem.

The Switch Profile defines 2 types of CIM_ComputerSystems: Switch and Partitioned Switch. These are similar to the Fabric definitions of Switch and Partitioned Switch ComputerSystems, but there are slight differences. In addition, if the Switch Partitioning Profile is implemented, the "Partitioning" CIM_ComputerSystem and "Partitioned" CIM_ComputerSystem are introduced. These are the same as the partitioning and partitioned CIM_ComputerSystems defined in Virtual Fabrics.

For FCPort, the distinguishing property is the PortDiscriminator property of FCPort for most types of FCPort. A Partitioned Switch FCPort contains a "3" in its PortDiscriminator. An IFR FCPort contains either a "5" or "6" in its PortDiscriminator. An NPIV FCPort (either Host or Fabric) contains a "7" in its PortDiscriminator. An FCPort that is virtualized on an Ethernet port has a PortDiscriminator of "10". Other Ports are "undistinguished" (Platform FCPorts, non-virtual FCPorts, Gateway FCPorts and Network Ports). For these ports they would need to be distinguished by association. For example, a Network Port would be the Antecedent of a HostedDependency association from an FCPort. A Gateway FCPort would NOT be a Fabric NPIV FCPort that is also associated to a Gateway (N Port Virtualizer) ComputerSystem. Platform FCPorts would have a SystemDevice association to either a Platform ComputerSystem (Host or Storage) or to a Fabric AdminDomain. Non-virtual FCPorts are ports that have a SystemDevice to one of the switch ComputerSystems and do not have a PortDiscriminator property or it has one that does not contain the value "3".

B.3 Property and Association Requirements

For each of the multiple types of class instances for CIM_AdminDomain, CIM_ComputerSystem and CIM_FCPort there are differences in property requirements and association patterns.

B.3.1 CIM_AdminDomain Requirements

Table B.1 identifies the properties of CIM_AdminDomain to be supported by SAN, Fabric, and Ethernet instances. The values for the distinguishing properties are identified. Otherwise, the property merely identifies whether it is Mandatory, Optional or Conditional. If it is Conditional, the condition is identified in the notes at the bottom of Table B.1.

Table B.1 - AdminDomain Properties

AdminDomain Property	SAN	Fabric	Ethernet (2)
CreationClassName	Mandatory	Mandatory	Mandatory
Name	Mandatory	Mandatory	Mandatory
NameFormat	Mandatory	Mandatory	Mandatory
ElementName	Optional	Optional	
OtherIdentifyingInfo	Mandatory - "SAN"	Mandatory - "Fabric" Conditional (1) - Virtual Fabric ID	Mandatory - "Ethernet"
IdentifyingDescriptions	Mandatory - "SNIA:DetailedType"	Mandatory - "SNIA:DetailedType" Conditional (1) - "SNIA:VF_ID"	Mandatory - "SNIA:DetailedType"
(1) - If the Virtual Fabrics Profile is implemented, then the OtherIdentifyingInfo will contain a virtual fabric ID and the IdentifyingDescriptions will contain "SNIA:VF_ID" (2) - The Ethernet AdminDomain is only required inf the FCoE Fabric profile is implemented.			

A SAN AdminDomain has an OtherIdentifyingInfo value of "SAN" and a Fabric AdminDomain has an OtherIdentifyingInfo value of "Fabric". Each must have a corresponding value of "SNIA:DetailedType" in the IdentifyingDescriptions array property. In addition, if the Virtual Fabrics Profile is implemented, the Fabric AdminDomain would also have a virtual fabric ID in the OtherIdentifyingInfo array property (with a corresponding "SNIA:VF_ID" in the IdentifyingDescriptions array property).

In addition, the fabric shall have a "Ethernet" AdminDomain if the fabric is an FCoE Fabric (that is, the FCoE Fabric profile is implemented).

Graphically, this is illustrated in Figure B.2. The SAN, Fabric, and Ethernet instances are different (as distinguished by OtherIdentifyingInfo and IdentifyingDescriptions). For Virtual Fabrics, a virtual fabric ID also shows up in the OtherIdentifyingInfo array property.

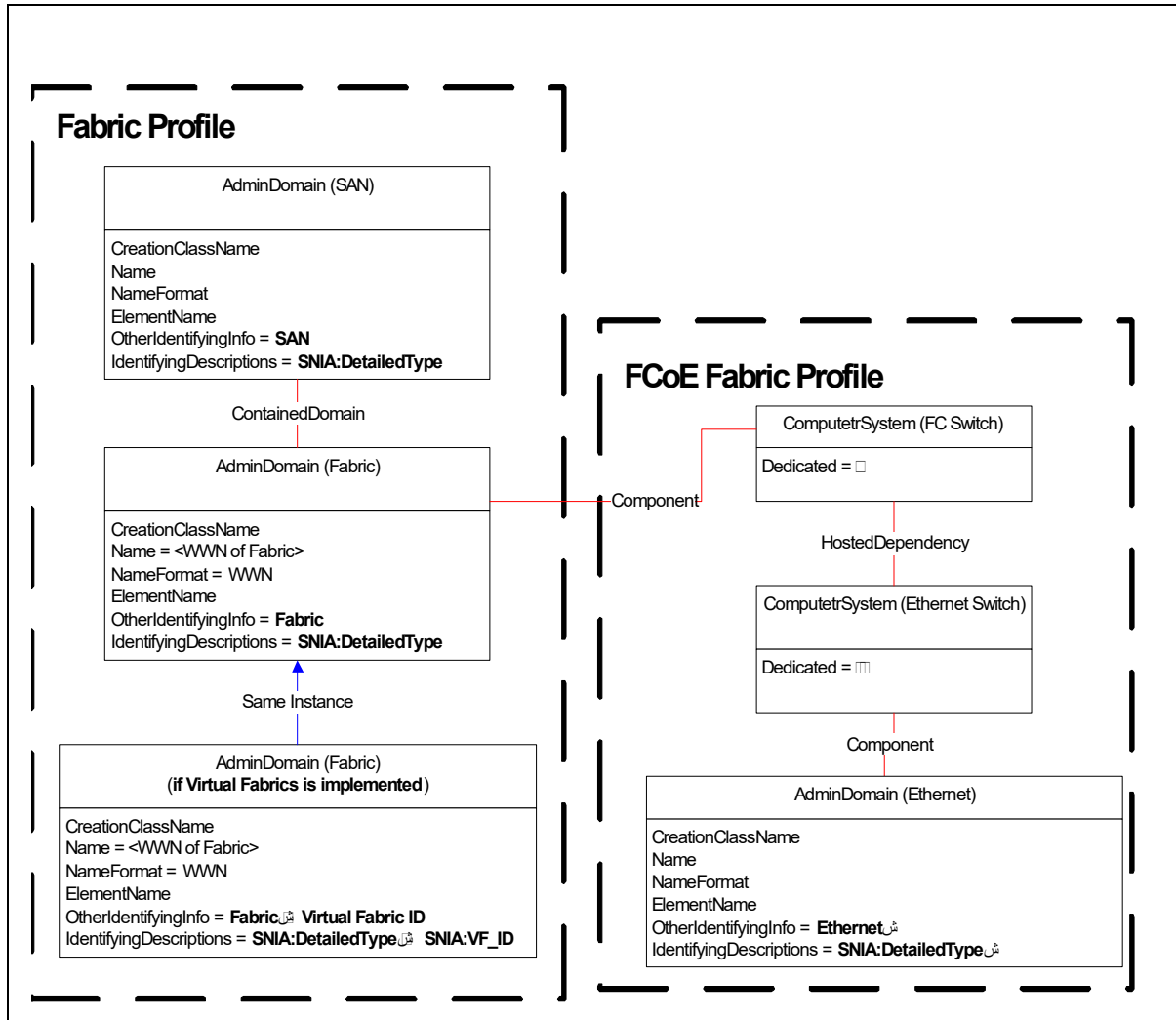

Figure B.2 - AdminDomain Properties

The association pattern for CIM_AdminDomain instances is illustrated in Table B.2

Table B.2 - AdminDomain Associations

Association on AdminDomain	SAN	Fabric	Ethernet
ContainedDomain to AdminDomain (SAN or Fabric)	Mandatory	Mandatory	N/A
ElementConformsToProfile to RegisteredProfile (for Fabric)	N/A	Mandatory	N/A
ElementConformsToProfile to RegisteredProfile (for Virtual Fabric)	Conditional (1)	N/A	N/A
ElementConformsToProfile to RegisteredProfile (for FCoE Fabric)	N/A	N/A	Conditional (5)
Component to ComputerSystem (Partitioning)	Conditional (2)	N/A	N/A

Table B.2 - AdminDomain Associations

Association on AdminDomain	SAN	Fabric	Ethernet
Component to ComputerSystem (Switch, Partitioned Switch or IFR Switch)	N/A	Mandatory	N/A
Component to ComputerSystem (Ethernet Switch)	N/A	N/A	Mandatory
ElementCapabilities to ZoneCapabilities	N/A	Mandatory	N/A
HostedCollection to ConnectivityCollection	N/A	Mandatory	Mandatory (to collection of LANEndpoints)
HostedCollection to Zone (Active or Inactive)	N/A	Mandatory	N/A
HostedCollection to ZoneSet (Active or Inactive)	N/A	Mandatory	N/A
Component to ComputerSystem (Storage or Host)	N/A	Optional	N/A
HostedAccessPoint to ProtocolEndpoint (Host or Storage)	N/A	Optional	N/A
HostedAccessPoint to LANEndpoint	N/A	N/A	Mandatory
SystemDevice to FCPort (non-Switch FCPort)	N/A	Optional	N/A
SystemDevice to EthernetPort (non-Switch EthernetPort to Ethernet AdminDomain)	N/A	N/A	Mandatory
HostedService to a ZoneService	N/A	Optional (3)	N/A
HostedCollection to a NamedAddressCollection	N/A	Conditional (4)	N/A
(1) - The ElementConformsToProfile from the SAN AdminDomain to the Virtual Fabrics RegisteredProfile is conditional on the implementation of the Virtual Fabrics Profile (2) - The Component from the SAN AdminDomain to the ComputerSystem (Partitioning) is conditional on the implementation of the Virtual Fabrics Profile (and Switch Partitioning) (3) - The HostedService association is optional if the Zone Control Profile is implemented. (4) - The HostedCollection to a NamedAddressCollection is conditional on the implementation of the Enhanced Zoning and Zoning Control Profile (5) - This is required if the FCoE Fabric profile is implemented			

Both the SAN and Fabric share the ContainedDomain association (they point to each other). All other associations are unique to either the SAN or Fabric AdminDomain instances. Note that some associations are conditional on implementation of certain component profiles. For example, if the Virtual Fabric component profile is implemented, an ElementConformsToProfile is required between the SAN AdminDomain and the Virtual Fabric RegisteredProfile. And if Switch Partitioning is implemented, then an ElementConformsToProfile is required between the Partitioning System and the Switch Partitioning RegisteredProfile.

Some of the associations are listed as Optional (#). For example, the HostedService association between a Fabric AdminDomain and a ZoneService is optional if the Zone Control Profile is implemented. It is optional, because the ZoneService may be hosted on either a Fabric AdminDomain or a Switch ComputerSystem.

Graphically, this is illustrated in Figure B.3 (Optional associations are not shown for simplicity).

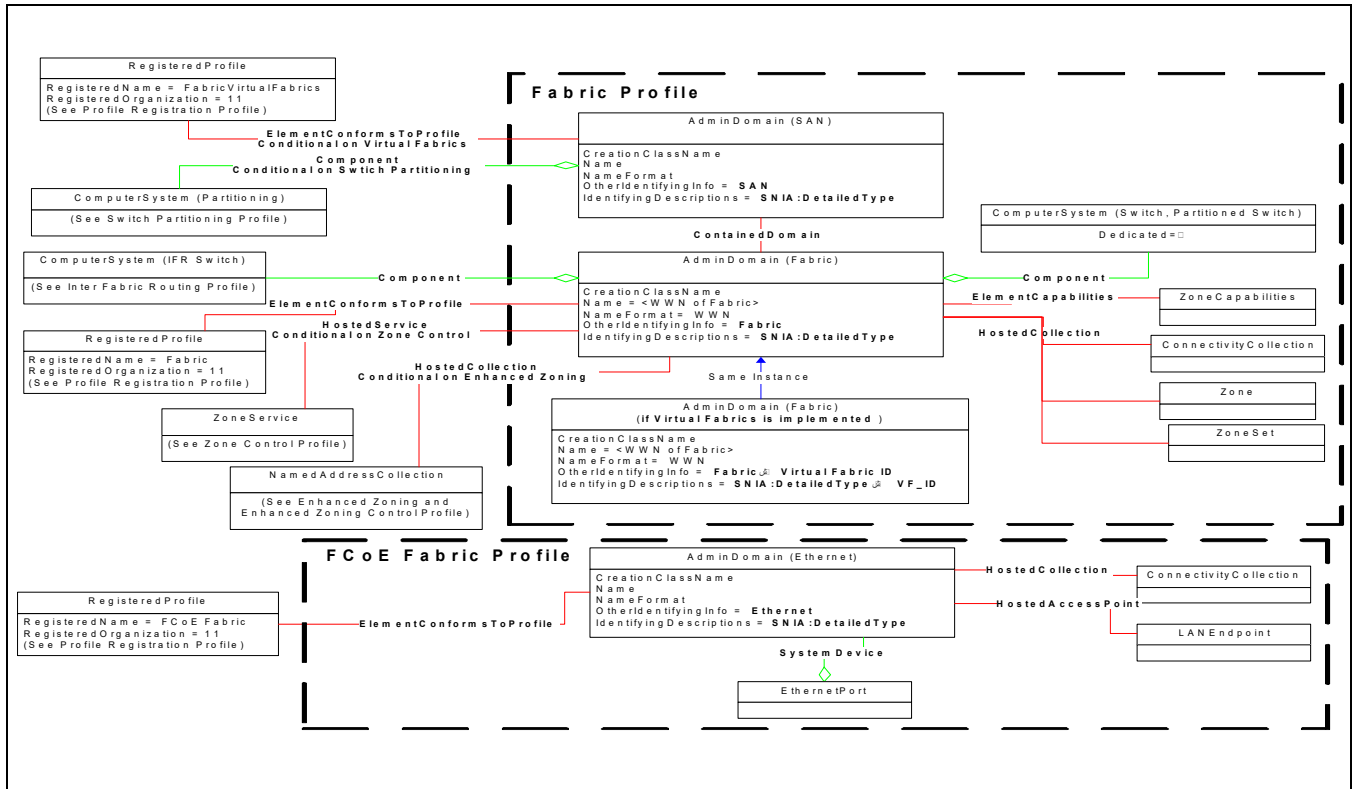

Figure B.3 - Associations on AdminDomains

For simplicity, the optional associations are not shown in Figure B.3. A SAN AdminDomain only has the ContainedDomain association to the Fabric AdminDomain. But if Virtual Fabrics (and Switch Partitioning) are implemented, then there are two more associations: An ElementConformsToProfile to the Virtual Fabrics RegisteredProfile and a Component association to the Partitioning ComputerSystem.

All associations on the Fabric AdminDomain would also apply to the Virtual Fabric. The ElementConformsToProfile goes to the Fabric RegisteredProfile in both cases. All Switches that participate in the Fabric have a Component association to the Fabric AdminDomain. This includes partitioned switches (and IFR Switches, if the Inter Fabric Routing Profile is implemented). In addition, all ConnectivityCollections, Zones and ZoneSets for the Fabric are Hosted on the Fabric AdminDomain. And the ZoneCapabilities are associated to the Fabric AdminDomain.

Other associations (e.g., HostedService to the ZoneService and HostedCollection to NamedAddressCollections) are required if certain component profiles are implemented (as indicated in Figure B.3).

For FCoE Fabric, the LANEndpoints and non-switch Ethernet Ports are mandatory, so the HostedAccessPoint and SystemDevice associations are also mandatory.

B.3.2 CIM_ComputerSystem Requirements

The various types of CIM_ComputerSystems instances may or may not be referring to an instance. For example, if both the Fabric and Switch Profiles are implemented, the Switch ComputerSystems defined in both profiles refer to the same instance (and the requirements from Fabric and Switch Profiles both apply to the instance).

Similarly, if a Partitioned ComputerSystem also happens to be a Partitioned Switch, then both the requirements of the Partitioned ComputerSystem and the Partitioned Switch apply to the ComputerSystem instance.

In order to explain the various types of ComputerSystems, the various types of Switch ComputerSystems are treated first. Then the other types of ComputerSystems will be addressed.

B.3.2.1 Switch ComputerSystems

Table B.3 identifies the properties of CIM_ComputerSystem to be supported by Switch ComputerSystem instances. The values for the distinguishing properties are identified. Otherwise, the property merely identifies whether it is Mandatory, Optional or Conditional. If it is Conditional, the condition is identified in the footnotes of Table B.3

Table B.3 - Switch ComputerSystem Properties

Computer System Property	Switch	Partitioned Switch	IFR Switch	Backbone Switch
CreationClassName	Mandatory	Mandatory	Mandatory	Mandatory
Name	Mandatory	Mandatory	Mandatory	Mandatory
ElementName	Conditional (1)	Conditional (1)	Mandatory	Mandatory
NameFormat	Mandatory	Mandatory	Mandatory	Mandatory
OperationalStatus	Mandatory	Mandatory	Mandatory	Mandatory
OtherIdentifyingInfo	Conditional (1)	Conditional (1) Virtual Fabric ID Conditional (3) "Virtual Switch"	Mandatory "Translate Domain" or "Front Domain"	Mandatory "Backbone"
IdentifyingDescriptions	Conditional (1)	Conditional (1) "SNIA:VF_ID" Conditional (3) "SNIA:DetailedType"	Mandatory "SNIA:DetailedType"	Mandatory "SNIA:DetailedType"
Dedicated	Mandatory - "5"	Mandatory - "5"	Mandatory - "5"	Mandatory - "5"
EnabledState	Conditional (1)	Conditional (1)	Mandatory	Mandatory
RequestedState	Conditional (2)	Conditional (2)	Conditional (2)	Conditional (2)
EnabledDefault	Optional	Optional	Optional	Optional
RequestedStateChange()	Conditional (2)	Conditional (2)	Conditional (2)	Conditional (2)
(1) - ElementName, OtherIdentifyingInfo and IdentifyingDescriptions are Mandatory if the Fabric Profile is implemented. (2) - RequestedState is Mandatory if the Switch Profile is implemented and FCSwitchCapabilities.RequestedStatesSupported is not NULL. (3) - OtherIdentifyingInfo and IdentifyingDescriptions are Mandatory if Switch Partitioning is implemented. If Switch Partitioning is implemented the Partitioned system that is a Switch has the value "Virtual Switch" and a corresponding "SNIA:DetailedType"				

The current assumption is that a partitioned switch and an IFR Switch are logically subclasses of Switch and if the Switch Profile is implemented, then the RequestedStateChange method is to be supported as defined for the base switch. However, state change is not currently covered in either the Switch Partitioning or the Inter Fabric Routing Profiles.

The first thing to notice is that a Switch always has Dedicated="5". That is, it is a ComputerSystem that performs some switch related functions. If the Fabric Profile has been implemented, then OtherIdentifyingInfo and IdentifyingDescriptions are also required. If OtherIdentifyingInfo only contains the DomainID of the Switch, then it is not a Partitioned Switch or an IFR Switch. If it also contains "Translate Domain" or "Front Domain", then it is an IFR Switch. If it also contains "Backbone", then it is a

backbone switch. If it contains "Virtual Switch", then it is a Partitioned Switch and it will also contain the virtual fabric ID.

If only the Switch Profile has been implemented, then OtherIdentifyingInfo and IdentifyingDescriptions may not be present. If the Switch Profile has been implemented, then the RequestedStateChange method may also be supported. This would be conditional on the FCSwitchCapabilities have a non-NULL value for the RequestedStatesSupported property.

Graphically, the various switches are represented by Figure B.4.

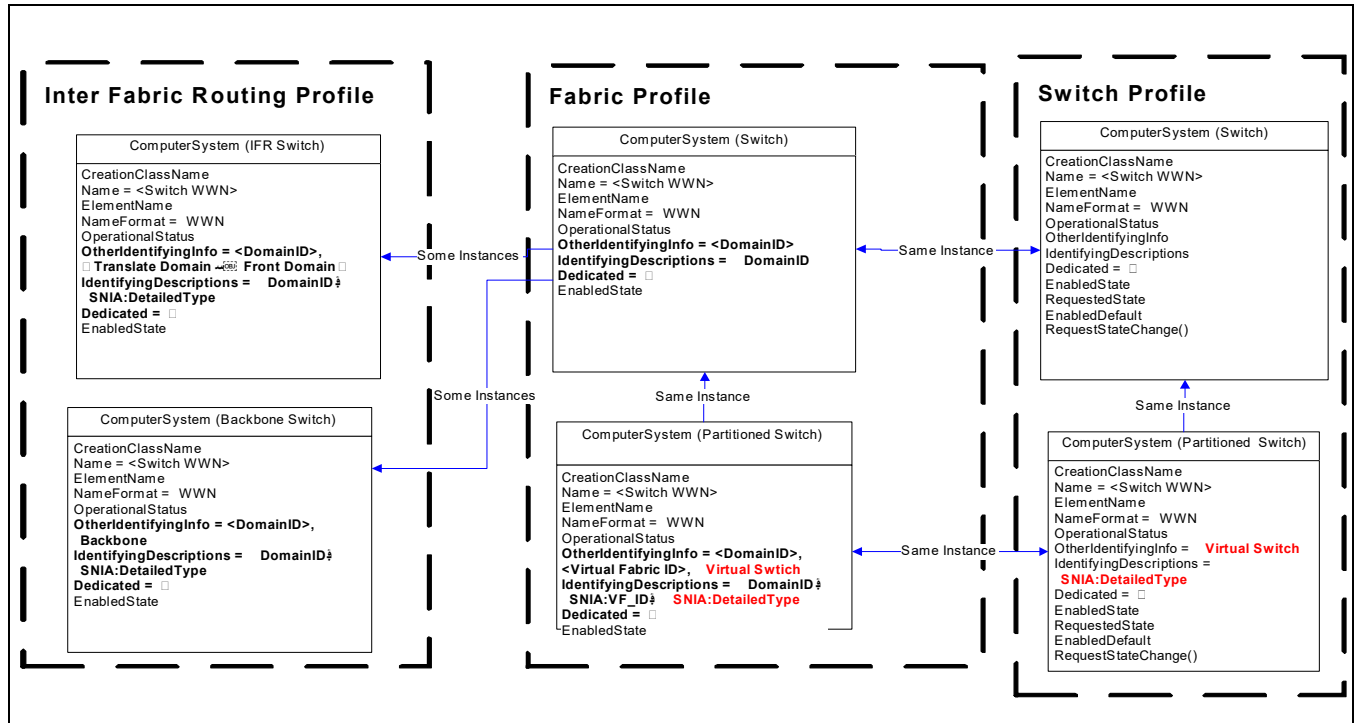

Figure B.4 - Properties of various Switches

The Fabric and Switch Profile versions of the Switch ComputerSystem are different. However, they represent the same instance. So if both profiles are implemented, then the requirements are merged. The Fabric requirement for OtherIdentifyingInfo applies, as does the extra properties called for by the Switch Profile definition of the Switch ComputerSystem. If the Virtual Fabrics or Switch Partitioning Profiles are implemented, then the Partitioned Switch ComputerSystem(s) are implemented. These augment the definitions of the base Switch profiles. So, in any given implementation one of the above definitions of the Switch or Partitioned Switch ComputerSystem definitions apply (depending on what profiles have been implemented).

In contrast, the IFR Switch and the backbone Switch ComputerSystems are constrained versions of the Fabric (or Virtual Fabric) definition of a Switch. Specifically, it defines the set of switches that are constrained to "Translate Domain", "Front Domain" or "Backbone" switches.

The association pattern for Switch CIM_ComputerSystem instances is illustrated in Table B.4.

Table B.4 - Switch ComputerSystem Associations

Association on Switch ComputerSystem	Switch	Partitioned Switch	IFR Switch	Backbone Switch
SystemDevice to an FCPort (Switch FCPort)	Mandatory	Mandatory	Mandatory	Mandatory

Table B.4 - Switch ComputerSystem Associations

Association on Switch ComputerSystem	Switch	Partitioned Switch	IFR Switch	Backbone Switch
Component to an AdminDomain (Fabric)	Conditional (1)	Conditional (1)	Mandatory	Mandatory
ElementCapabilities to a ZoneCapabilities	Conditional (1)	Conditional (1)	Mandatory	Mandatory
HostedAccessPoint to a ProtocolEndpoint	Conditional (1)	Conditional (1)	Mandatory	Mandatory
HostedCollection to a Zone	Conditional (1)	Conditional (1)	Mandatory	Mandatory
HostedCollection to a ZoneSet	Conditional (1)	Conditional (1)	Mandatory	Mandatory
InstalledSoftwareIdentity to a SoftwareIdentity	Conditional (2)	Conditional (2)	Conditional (2)	Conditional (2)
ComputerSystemPackage to a PhysicalPackage	Conditional (2)	Conditional (2)	Conditional (2)	Conditional (2)
ElementCapabilities to an FCSwitchCapabilities	Conditional (2)	Conditional (2)	Conditional (2)	Conditional (2)
HostedCollection to a StatisticsCollection	Conditional (2)	Conditional (2)	Conditional (2)	Conditional (2)
HostedDependency to a ComputerSystem (Partitioning)	Conditional (3)	Conditional (3)	Conditional (3)	Conditional (3)
SystemDevice to a LogicalModule	Conditional (4)	Conditional (4)	Conditional (4)	Conditional (4)
HostedService to a ZoneService	Optional (5)	Optional(5)	Optional (5)	Optional(5)
HostedCollection to a NamedAddressCollection	Conditional (6)	Conditional (6)	Conditional (6)	Conditional (6)
(1) - Conditional on the implementation of the Fabric Profile (2) - Conditional on the implementation of the Switch Profile (3) - Conditional on the implementation of the Switch Partitioning Profile (or Virtual Fabrics) (4) - Conditional on the implementation of the Blades Profile (5) - Optional presence with the implementation of the Zone Control Profile (6) - The HostedCollection to a NamedAddressCollection is conditional on the implementation of the Enhanced Zoning and Zoning Control Profile				

From Table B.4 the only association that is common to both all definitions of switches is the SystemDevice association to FCPorts. All other associations are conditional on one of three profiles: The Fabric Profile, the Switch Profile, or the Switch Partitioning Profile.

The associations defined in the Fabric Profile are to Fabric-related classes (e.g., Zones or Zonesets). The associations defined in the Switch Profile are to Switch-related classes (e.g., FCSwitchCapabilities). The one association introduced by the Switch Partitioning Profile is the HostedDependency association to the Partitioning ComputerSystem.

NOTE The IFR Switch has no unique associations. It inherits its associations from the Fabric (and Switch) definitions.

Associations are illustrated in Figure B.5.

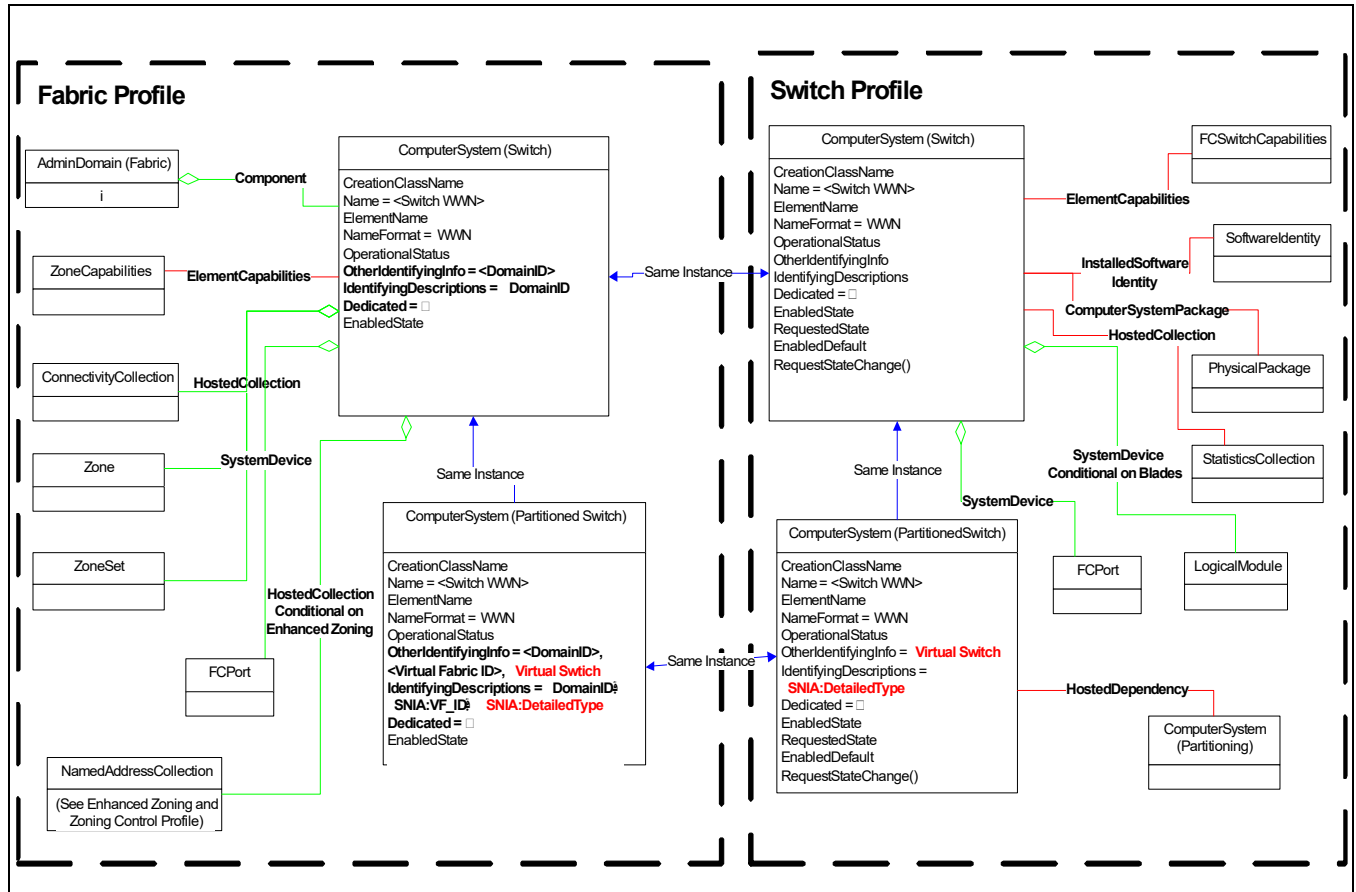

Figure B.5 - Associations on Switches

As illustrated by Figure B.5 there is "shrub" of associations defined by the Fabric Profile for Switch (and Partitioned Switch) ComputerSystems. These associations are to classes defined in the Fabric Profile (e.g., the Fabric AdminDomain). Similarly, there is a "shrub" of associations defined by the Switch Profile for Switch (and Partitioned Switch) ComputerSystems. These associations are to classes defined in the Switch Profile (e.g., FCSwitchCapabilities). Both the Fabric and Switch Profiles define the same association to FCPorts (the SystemDevice association). If Fabric Profile implementation does not also implement the Switch Profile, then only the shrub of Fabric associations need be implemented. And if a Switch Profile implementation does not also implement the Fabric Profile, then only the shrub of Switch associations need to be implemented.

Partitioned Switches, in either case, inherit the associations defined for the Switch ComputerSystems. So, for example, a Partitioned Switch needs to have an associated PhysicalPackage.

The Switch Partitioning Profile introduces the requirement to model the HostedDependency from the Partitioned Switch ComputerSystem to a Partitioning ComputerSystem.

B.3.2.2 Non-Switch ComputerSystems

Table B.5 identifies the properties of CIM_ComputerSystem to be supported by non-Switch ComputerSystem instances. The values for the distinguishing properties are identified. Otherwise, the property merely identifies whether it is Mandatory, Optional or Conditional. If it is Conditional, the condition is identified in the footnotes of Table B.5.

Table B.5 - Non-Switch ComputerSystem Properties

Computer System Property	Host Platform	Storage Platform	Gateway	Partitioning	Partitioned	Ethernet
CreationClassName	Mandatory	Mandatory	Mandatory	Mandatory	Mandatory	Mandatory
Name	Mandatory	Mandatory	Mandatory	Mandatory	Mandatory	Mandatory
ElementName	Mandatory	Mandatory	Mandatory			Mandatory
NameFormat	Mandatory	Mandatory	Mandatory			Mandatory
OperationalStatus			Mandatory			Mandatory
Dedicated	"0" or "1"	"1" or "3"	"20"	"0" Plus	Mandatory	"38"
OtherIdentifyingInfo					Conditional (1)	
IdentifyingDescriptions					Conditional (1)	
EnabledState					Mandatory	Mandatory
(1) - The OtherIdentifyingInfo and IdentifyingDescriptions are required if Virtual Fabrics is implemented (to identify the VF_ID for the Partitioned System)						

The primary way of distinguishing the non-switch ComputerSystems is via the Dedicated property, although it is not always deterministic from just the Dedicated property. For example, a Host Platform ComputerSystem may have Dedicated="0" (for Host) or "1" ("unknown"). A Storage Platform may have Dedicated="3" (for storage) or "1" ("unknown"). There is no way to determine if a Platform is storage or host, if the value "1" ("unknown") is used. All we know is that it would be an end node (a Platform).

A Gateway ComputerSystem is distinguished by Dedicated="20". A Partitioning system would have multiple values in the Dedicated property and one of those values would be "0" (NOTE: This would distinguish it from a Host Platform, which would only have the single value of "0").

A Partitioned system would have a Dedicated value that corresponds to the function performed by the Partitioned system (e.g., "20" if the partitioned system is a Gateway).

A Ethernet Switch would have a Dedicated value of "38" (Ethernet Switch).

Figure B.6 illustrates these systems and their properties graphically.

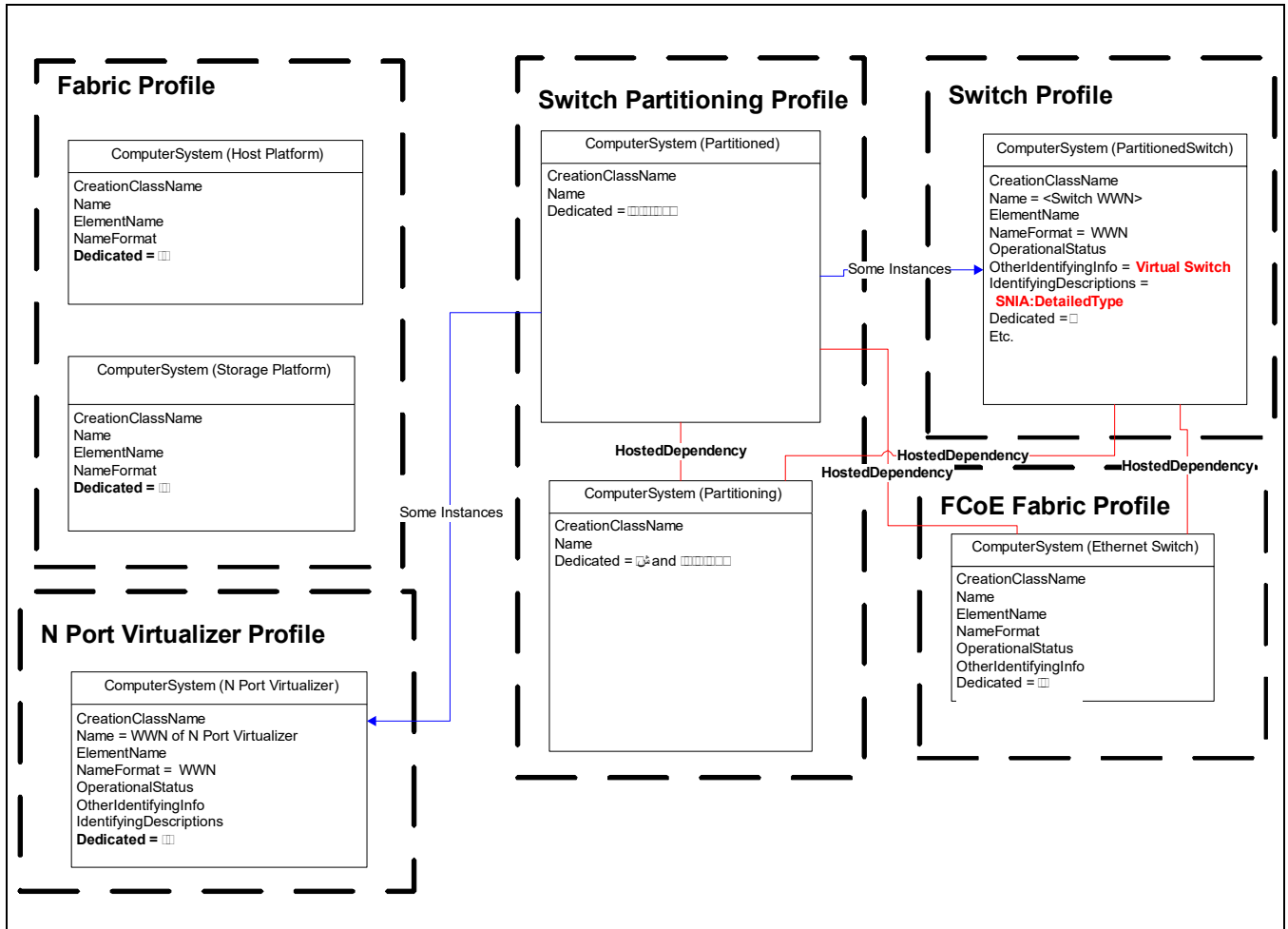

Figure B.6 - General ComputerSystem Properties

For the most part, each of the instances shown in Figure B.6 represent different instances. The only exception is the Partitioned ComputerSystem which can be any partitioned switch or a Gateway ComputerSystem. A Platform cannot be a Partitioned System (it is virtual with no physical representation). The Ethernet Switch behaves like a partitioning switch in an FCoE environment.

The association pattern for non-Switch CIM_ComputerSystem instances is illustrated in Table B.6.

Table B.6 - Non-Switch ComputerSystem Associations

Association on ComputerSystem	Host Platform	Storage Platform	Gateway	Partitioning	Partitioned	Ethernet
Component to a Fabric AdminDomain	Optional Conditional (1)	Optional Conditional (2)	Conditional (3)		Conditional (4)	
HostedAccessPoint to ProtocolEndpoints	Mandatory Conditional (1)	Mandatory Conditional (2)				
SystemDevice to FCPorts	Optional Conditional (1)	Optional Conditional (2)				

Table B.6 - Non-Switch ComputerSystem Associations

Association on ComputerSystem	Host Platform	Storage Platform	Gateway	Partitioning	Partitioned	Ethernet
HostedAccessPoint to an N Port Virtualizer ProtocolEndpoint			Mandatory			
SystemDevice to NPIV or Gateway FCPorts			Mandatory			
SystemDevice to a NetworkPort				Mandatory		
Component to SAN AdminDomain				Mandatory		
HostedDependency to a Partitioned ComputerSystem				Mandatory		
ElementConformsTo Profile to a Switch Partitioning RegisteredProfile				Mandatory		
SystemDevice to a Virtual FCPort					Mandatory	
HostedDependency to a Partitioning System					Mandatory	
Component to an Ethernet AdminDomain						Mandatory
HostedAccessPoint to LANEEndpoints						Mandatory
SystemDevice to EthernetPorts						Mandatory
HostedDependency to an FC Switch						Optional
(1) - The Component, HostedAccessPoint and SystemDevice Associations are conditional on the implementation of the Host Platform ComputerSystem (2) - The Component, HostedAccessPoint and SystemDevice Associations are conditional on the implementation of the Storage Platform ComputerSystem (3) - The Component Association to the Fabric is conditional on the implementation of the N Port Virtualizer Profile (4) - The Component Association to the Fabric is conditional on implementation of the Fabric Profile (and the Virtual Fabric Profile).						

From Table B.6 each type of non-switch ComputerSystem instance has its own "shrub" of associations. If a Host Platform ComputerSystem is instantiated, then it is to have a Component association to its Fabric, and HostedAccessPoint and SystemDevice associations for its ProtocolEndpoints and FCPorts. A similar set of associations are required for Storage Platform ComputerSystem instances.

Notice also that all of these non-switch types of ComputerSystem instances have the Component association to some Fabric AdminDomain, with the exception of the Partitioning ComputerSystem. The Partitioning ComputerSystem has its Component association to a SAN AdminDomain. The Partitioning ComputerSystem instances also have an ElementConformsToProfile association to the RegisteredProfile instance for the Switch Partitioning Profile (to which it conforms).

Finally, notice that a Partitioned ComputerSystem instance has a HostedDependency association to a Partitioning ComputerSystem instance (or an Ethernet Switch ComputerSystem).

This is graphically illustrated in Figure B.7.

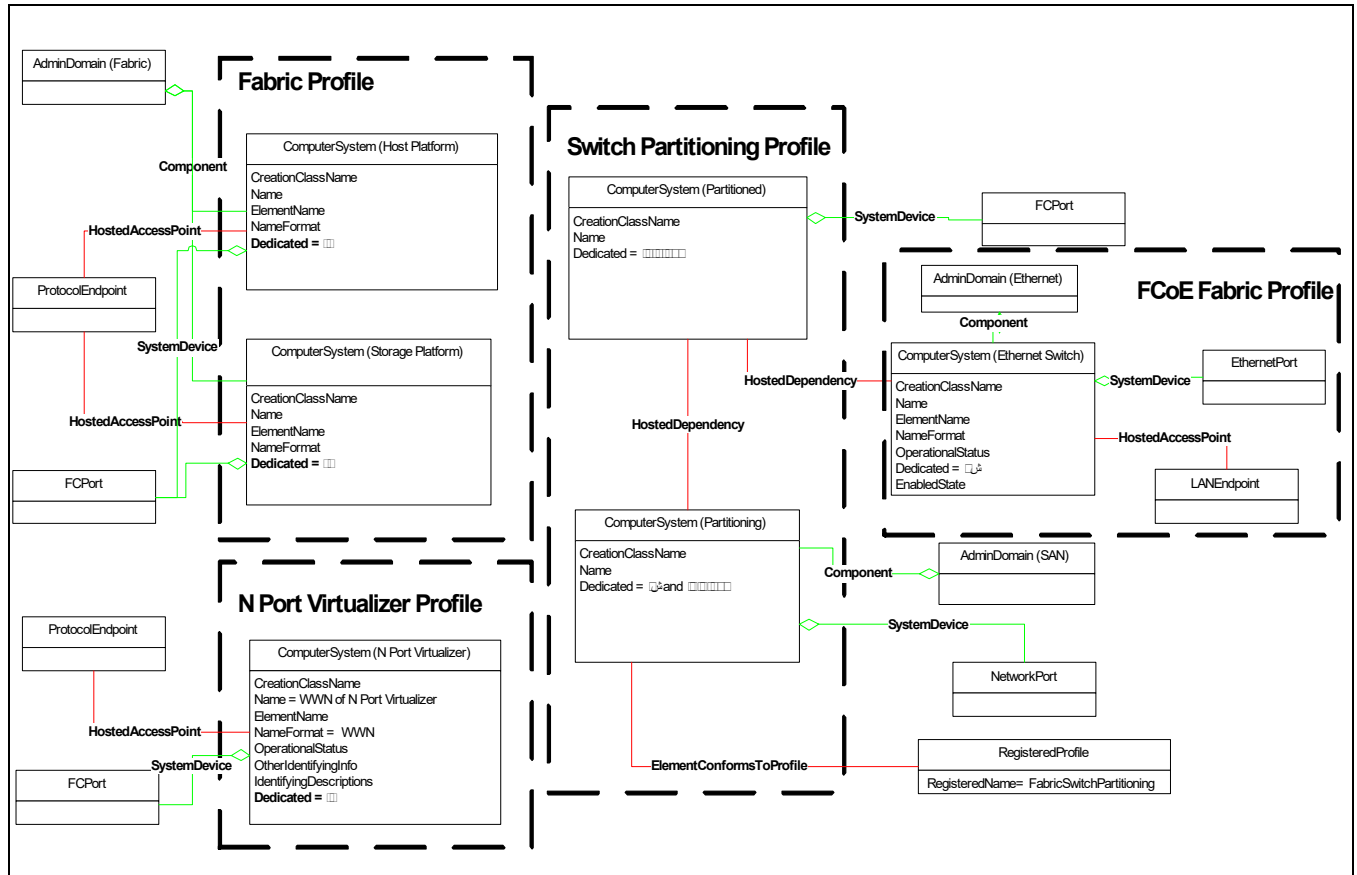

Figure B.7 - General ComputerSystem Associations

In Figure B.7 we can see the non-Switch ComputerSystems and their associations. Each has some sort of port associated to it via SystemDevice. All except the Partitioning ComputerSystem are associated to an FCPort. The Partitioning ComputerSystem is associated to a NetworkPort (which may or may not be an FCPort). For an FCoE environment, the partitioning ComputerSystem is an Ethernet Switch and the ports are EthernetPorts. ComputerSystems defined in the Fabric Profile (or the N Port Virtualizer component profile of Fabric) also have associations to ProtocolEndpoints. The ComputerSystems in the Switch Partitioning Profile do not have ProtocolEndpoints (unless, of course, the Partitioned ComputerSystem also happens to be a Switch, N Port Virtualizer or Platform).

B.3.3 Port Requirements

B.3.3.1 Switch CIM_FCPort Requirements

Table B.7 identifies the properties of Switch CIM_FCPort to be supported by FCPort instances. The values for the distinguishing properties are identified. Otherwise, the property merely identifies whether it

is Mandatory, Optional or Conditional. If it is Conditional, the condition is identified in the footnotes of Table B.7.

Table B.7 - Switch FCPort Properties

Switch FCPort Property	Switch FCPort	Partitioned Switch FCPort	IFR FCPort
SystemCreationClassName	Mandatory	Mandatory	Mandatory
SystemName	Mandatory	Mandatory	Mandatory
CreationClassName	Mandatory	Mandatory	Mandatory
DeviceID	Mandatory	Mandatory	Mandatory
ElementName	Mandatory	Mandatory	Mandatory
PermanentAddress	Mandatory	Mandatory	Mandatory
OperationalStatus	Mandatory	Mandatory	Mandatory
PortType	Mandatory	Mandatory	Mandatory
LinkTechnology	Mandatory - "4"	Mandatory - "4"	Mandatory - "4"
EnabledState	Conditional (1)	Conditional (1)	Mandatory
Speed	Conditional (2)	Conditional (2)	Conditional (2)
DetailedPortState	Conditional (2)	Conditional (2)	Conditional (2)
RequestedState	Conditional (2)	Conditional (2)	Conditional (2)
EnabledDefault	Conditional (2)	Conditional (2)	Conditional (2)
MaxSpeed	Conditional (2)	Conditional (2)	Conditional (2)
PortNumber	Conditional (2)	Conditional (2)	Conditional (2)
RequestedStateChange()	Conditional (3)	Conditional (3)	Conditional (3)
PortDiscriminator	Optional	Conditional (4) - "3"	Mandatory - "5" or "6"
NetworkAddresses	N/A	N/A	N/A
PortAvailability	Optional	Optional	
SupportedFC4Types		N/A	N/A
SupportedCOS		N/A	N/A
<p>(1) - EnabledState is required if the Fabric Profile is implemented, otherwise it is optional. (2) - Several properties (e.g., Speed) are required if the Switch Profile is implemented, otherwise they are not required. (3) - Support for the RequestedStateChange method is required if the Switch Profile is implemented and FCPortCapabilities.RequestedStatesSupported is not empty. (4) - The PortDiscriminator will contain "3" if the Switch Partitioning (including Virtual Fabrics) is implemented.</p>			

From Table B.7 there are several properties (e.g., DeviceID) that are required for any implementation of a switch FCPort instance. In addition, EnabledState is required if the Fabric Profile is implemented. And there are several properties that are required if the Switch Profile is implemented.

The types of Switch FCPorts may be distinguished by the PortDiscriminator. The base definition of a Switch FCPort does not require a PortDiscriminator (in either Fabric or the Switch Profile). However, if switch partitioning (or Virtual Fabrics) are implemented, then the virtual ports will be distinguished by a PortDiscriminator value of "3". And an IFR Port will be distinguished by the value "5" or "6". Note that

these ports are the ports that are associated to a Translate Domain or Front Domain Switch. Ports on the Backbone switch would be undistinguished.

Figure B.8 Illustrates these instances graphically.

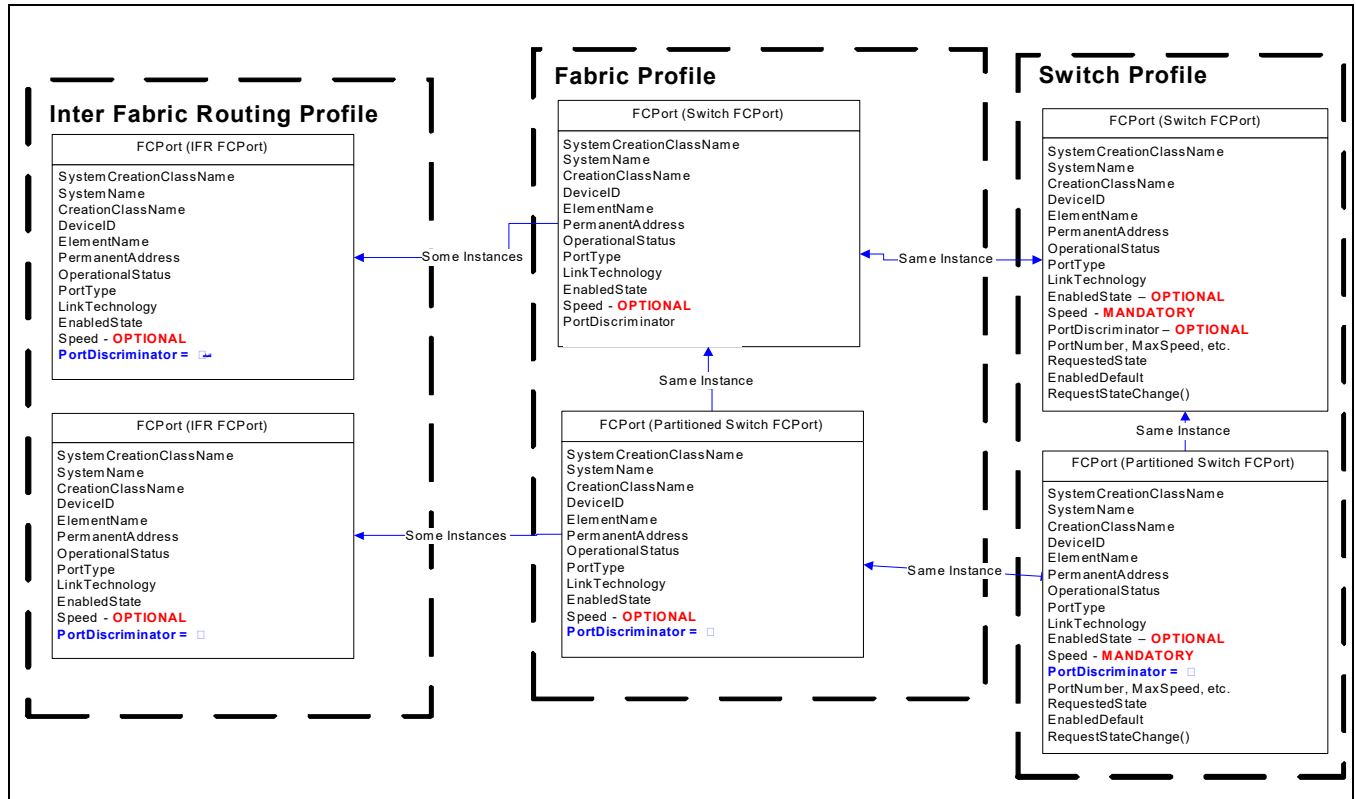

Figure B.8 - Switch FCPort Properties

The base definition of a Switch FCPort in both the Fabric and Switch Profiles are undistinguished (by PortDiscriminator). If Virtual Fabrics or Switch Partitioning are implemented, then the PortDiscriminator will contain "3" for Virtual FCPort. And IFR FCPorts (the ones associated to a Translate Domain or Front Domain) are distinguished by "5" (IFR) or "6" (IFR (Virtual IFR)).

Note that Backbone Switch FCPorts would be undistinguished from other Switch FCPorts. A Backbone Switch FCPort may be a virtual FCPort (PortDiscriminator="3").

The association pattern for Switch CIM_FCPort instances is illustrated in Table B.8.

Table B.8 - Switch FCPort Associations

Association on Switch FCPort	Switch FCPort	Partitioned Switch FCPort	IFR FCPort
SystemDevice to a Switch ComputerSystem	Mandatory	Mandatory	Mandatory
DeviceSAPIImplementation to a ProtocolEndpoint	Conditional (1)	Conditional (1)	Mandatory
ElementCapabilities to an FCPortCapabilities	Conditional (2)	Conditional (2)	Conditional (2)
ElementStatisticalData to an FCPortStatistics	Conditional (2)	Conditional (2)	Conditional (2)
ElementSettingData to an FCPortSettings	Optional (3)	Optional (3)	Optional (3)
ElementStatisticalData to an FCPortRateStatistics	Optional (3)	Optional (3)	Optional (3)

Table B.8 - Switch FCPort Associations

Association on Switch FCPort	Switch FCPort	Partitioned Switch FCPort	IFR FCPort
MemberOfCollection to a RedundancySet	Optional (3)	Optional (3)	Optional (3)
ModulePort to a LogicalModule	Conditional (4)	Conditional (4)	Conditional (4)
SystemDevice to a Partitioned ComputerSystem (or Switch)		Conditional (5)	Conditional (5)
HostedDependency to a NetworkPort		Conditional (5)	Conditional (5)
<p>(1) - The DeviceSAPImplementation to a ProtocolEndpoint is conditional on implementation of the Fabric Profile</p> <p>(2) - The ElementCapabilities and ElementStatisticalData to an FCPortStatistics are conditional on the implementation of the Switch Profile</p> <p>(3) - The ElementSettingData, ElementStatisticalData to an FCPortRateStatistics and MemberOfCollection may be present (optional) if the Switch Profile is implemented</p> <p>(4) - The ModulePort association is conditional on the implementation of the Blades Profile.</p> <p>(5) - If the Switch Partitioning Profile is implemented, then virtual FCPorts will have their SystemDevice association to a Partitioned Switch and the Virtual FCPorts will also have a HostedDependency to a Network Port (on a Partitioning System).</p>			

From Table B.8 all Switch FCPorts will have a SystemDevice association to some type of Switch ComputerSystem. All other associations are dependent on what profiles are implemented. For example, implementation of the Fabric Profile requires a DeviceSAPImplementation association from the Switch FCPort to a ProtocolEndpoint. And implementation of the Switch Profile requires the implementation of an

ElementCapabilities association to an FCPortCapabilities instance. Notice that a Virtual FCPort will have a HostedDependency to a NetworkPort of a Partitioning System, as illustrated in Figure B.9.

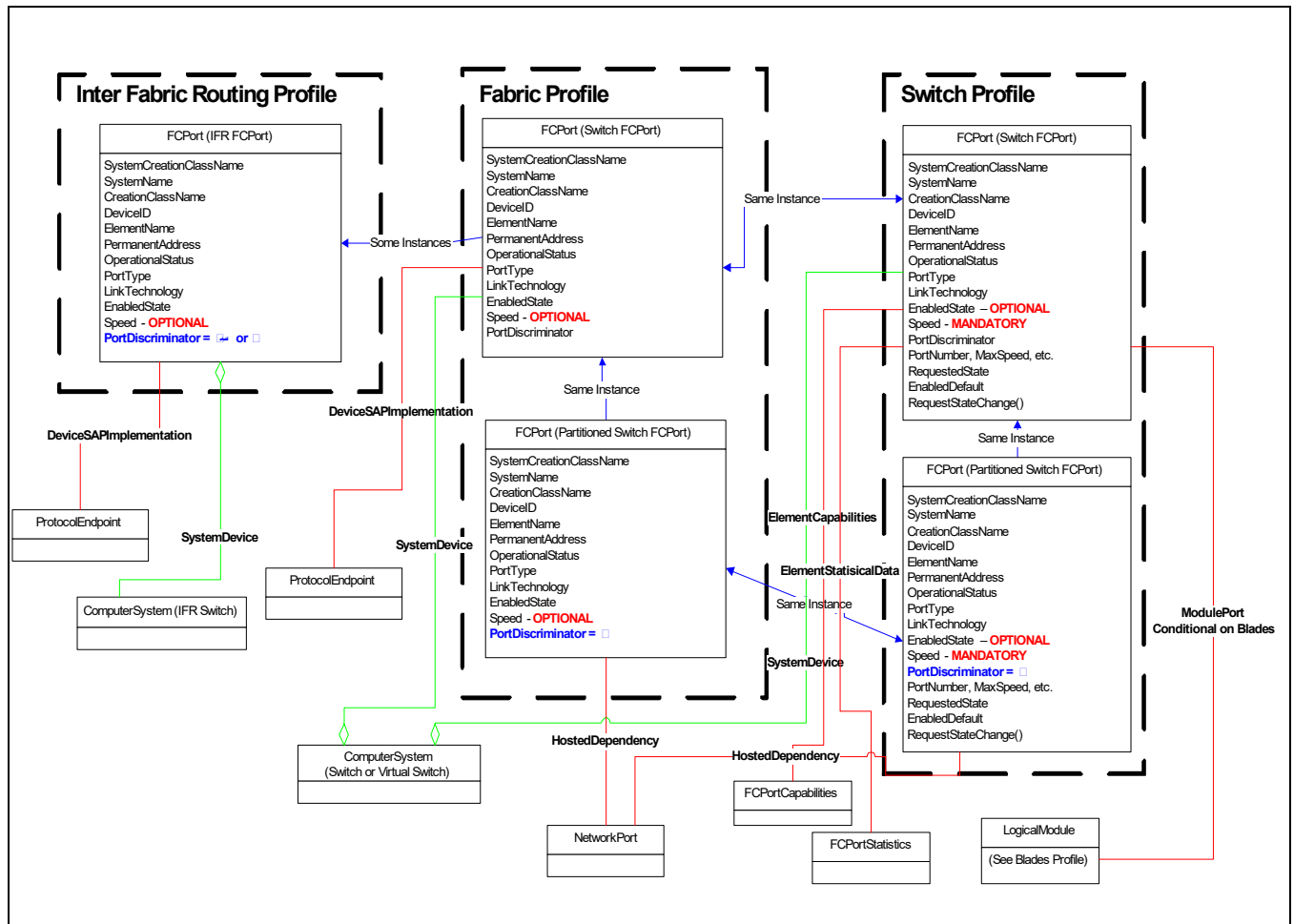

Figure B.9 - Switch FCPort Associations

Figure B.9 shows there are a "shrub" of associations that are called for (required) by the Fabric Profile and another "Shrub" of associations that are called for (required) by the Switch Profile. In general, ProtocolEndpoints are required if the Fabric Profile is implemented and FCPortCapabilities are required if the Switch Profile is implemented. In addition, if the Blades Profile is implemented, the switch FCPort will have a ModulePort association to the LogicalModule it is part of.

If a Switch FCPort has a PortDiscriminator property value of "3" it is a Partitioned Switch FCPort. The only association that is added to the picture if a port is a partitioned switch FCPort is the HostedDependency association to a NetworkPort on a Partitioning System.

B.3.3.2 Non-Switch Port Requirements

Table B.9 identifies the properties of non-switch ports to be supported by NetworkPort instances. The values for the distinguishing properties are identified. Otherwise, the property merely identifies whether it

is Mandatory, Optional or Conditional. If it is Conditional, the condition is identified in the footnotes of Table B.9.

Table B.9 - Non-Switch Port Properties

Port Property	Fabric NPIV FCPort	Gateway FCPort	Network Port	Ethernet Port	Host or Storage FCPort	Host NPIV FCPort
SystemCreationClassName	Mandatory	Mandatory	Mandatory	Mandatory	Mandatory	Mandatory
SystemName	Mandatory	Mandatory	Mandatory	Mandatory	Mandatory	Mandatory
CreationClassName	Mandatory	Mandatory	Mandatory	Mandatory	Mandatory	Mandatory
DeviceID	Mandatory	Mandatory	Mandatory	Mandatory	Mandatory	Mandatory
ElementName	Optional	Optional			Optional	Optional
PermanentAddress	Mandatory	Mandatory		Mandatory	Mandatory	Mandatory
OperationalStatus	Mandatory	Mandatory		Mandatory	Mandatory	Mandatory
PortType	Mandatory - "10"	Mandatory - "10"			Mandatory - "10"	Mandatory - "10"
LinkTechnology	Mandatory - "4"	Mandatory - "4"		Mandatory - "2"	Mandatory - "4"	Mandatory - "4"
NetworkAddresses	Mandatory	Mandatory			Mandatory	Mandatory
PortDiscriminator	Mandatory - "7"	Mandatory				Mandatory - "7"
SupportedFC4Types	Optional	Optional			Optional	Optional
SupportedCOS	Optional	Optional			Optional	Optional

From Table B.9 it can be seen that non-switch FCPorts are largely undistinguished. These, in general, must be distinguished by associations to other classes. Even the NPIV ports (PortDiscriminator="7") can be either a component of a N Port Virtualizer or a component of a Host Platform. Also notice that there are few requirements on the NetworkPorts, which are associated with the Partitioning System. In the case of an FCoE environment, Ethernet ports are both host ports and switch ports.

Figure B.10 Illustrates these instances graphically.

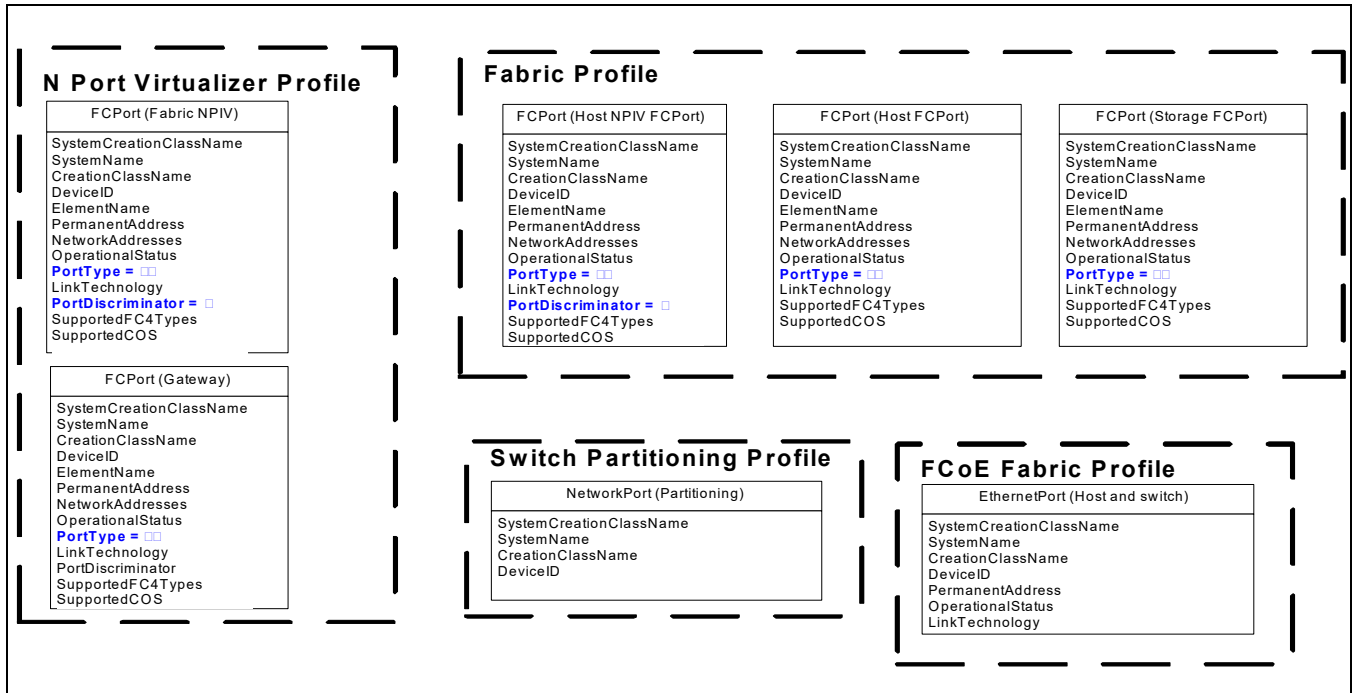

Figure B.10 - Non-Switch Port Properties

There are six different types of non-Switch FCPorts. The N Port Virtualizer FCPorts (Gateway and NPIV) are "switch like", but are associated to the N Port Virtualizer ComputerSystem. The non-switch Ports defined in the Fabric Profile are Platform (Host or Storage) FCPorts. The Host FCPorts may be NPIV FCPorts or not. The NetworkPort of the Switch Partitioning Profile may or may not be an FCPort. In the case of an FCoE environment, the NetworkPort is an EthernetPort and requires more properties.

All but the NetworkPort have a PortType="10" (an N port). NPIV ports (whether in the N Port Virtualizer or a Host Platform) have a PortDiscriminator="7". Other ports are not distinguished by properties.

The association pattern for non-switch port instances is illustrated in Table B.10.

Table B.10 - Non-Switch Port Associations

Association on Port	Fabric NPIV FCPort	Gateway FCPort	Network Port	Ethernet Port	Host or Storage FCPort	Host NPIV FCPort
DeviceSAPImplementation to a ProtocolEndpoint	Conditional (1)	Conditional (1)			Conditional (2)	Conditional (2)
DeviceSAPImplementation to a LANEndpoint				Conditional (6 or 7)		
HostedDependency to a NetworkPort	Conditional (3)	Conditional (3)				
HostedDependency to a Host FCPort				Conditional (6)		Mandatory
SystemDevice to a Gateway ComputerSystem	Mandatory	Mandatory				

Table B.10 - Non-Switch Port Associations

Association on Port	Fabric NPIV FCPort	Gateway FCPort	Network Port	Ethernet Port	Host or Storage FCPort	Host NPIV FCPort
MemberOfCollection to a LogicalPortGroup					Mandatory	
SystemDevice to a Platform (Host or Storage) ComputerSystem					Optional (4)	Optional (4)
SystemDevice to a Fabric AdminDomain					Optional (4)	
SystemDevice to an Ethernet AdminDomain				Conditional (6)		
SystemDevice to a Partitioned ComputerSystem (or Switch)					Conditional (5)	
SystemDevice to a Partitioning ComputerSystem			Mandatory			
SystemDevice to a Ethernet Switch ComputerSystem				Conditional (7)		
ElementCapabilities to a NetworkPortCapabilities			Mandatory			
ElementSettingData to a NetworkPortSettings			Mandatory			
<p>(1) - The DeviceSAPImplementation to a ProtocolEndpoint is conditional on the implementation of the N Port Virtualizer (for Fabric NPIV FCPorts and Gateway FCPorts).</p> <p>(2) - The DeviceSAPImplementation to a ProtocolEndpoint is conditional in the implementation of the Fabric Profile (for Host or Storage FCPorts, including Host NPIV FCPorts).</p> <p>(3) - The HostedDependency to a NetworkPort is conditional on the implementation of the Switch Partitioning Profile.</p> <p>(4) - For Platform (Host or Storage) FCPorts, a SystemDevice association is required to either a Fabric AdminDomain or a Platform ComputerSystem.</p> <p>(5) - This case may never happen.</p> <p>(6) - This is conditional on implementation of the FCoE Profile and for host ethernet ports</p> <p>(7) - This is conditional on implementation of the FCoE Profile and for ethernet switch ports</p>						

From Table B.10 one can see the unique associations for the various non-switch Ports. For Fabric NPIV FCPorts, the FCPort has a PortDiscriminator of "7" and is associated to an N Port Virtualizer. For a Gateway FCPort, it too is associated to an N Port Virtualizer, but its PortDiscriminator does not contain the value "7". For a NetworkPort, and an EthernetPort, it is associated to a Partitioning System and is the antecedent in a HostedDependency association. For a Host or Storage FCPort, it will have a SystemDevice association to a Host or Storage Platform ComputerSystem or to the Fabric AdminDomain. For the Host NPIV Port, it will also have a PortDiscriminator of "7", as illustrated in Figure B.11.

For simplicity, only the EthernetPort associated to the Ethernet Switch is shown in Figure B.11.

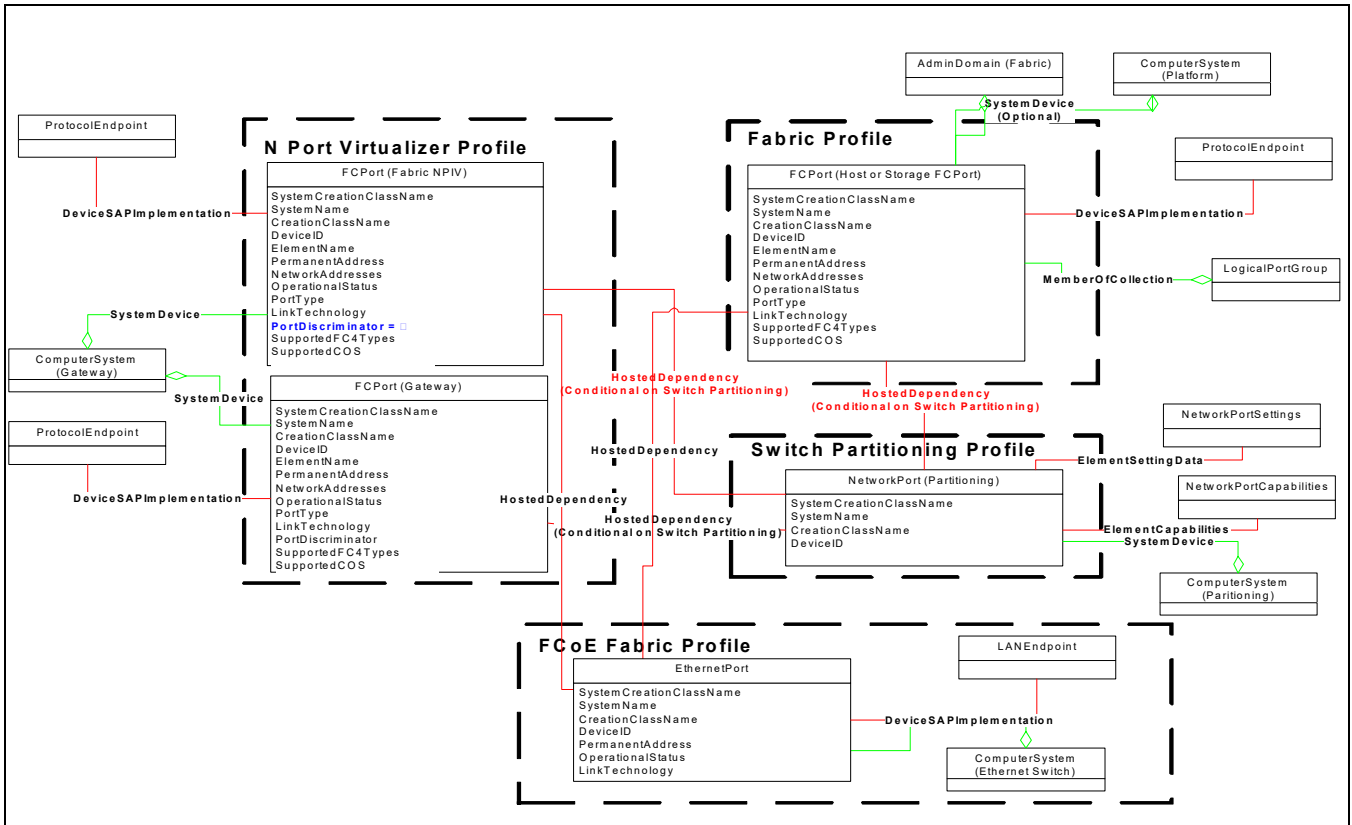

Figure B.11 - Non-Switch Port Associations

EXPERIMENTAL

